

Aluma  *Lite*[®] XL

Imperial[™]

MOTORIZED
OWNER'S MANUAL

THIS MANUAL HAS BEEN PROVIDED BY HOLIDAY RAMBLER CORPORATION® FOR THE SOLE PURPOSE OF PROVIDING INSTRUCTIONS ABOUT OPERATION AND MAINTENANCE OF THIS VEHICLE AND ITS COMPONENTS. NOTHING IN THIS MANUAL CREATES ANY WARRANTY, EITHER EXPRESS OR IMPLIED. THE ONLY WARRANTY OFFERED BY HOLIDAY RAMBLER CORPORATION® IS AS SET FORTH IN THE LIMITED WARRANTY APPLICABLE TO THIS VEHICLE.

THE OWNER'S FAILURE TO PROVIDE REQUIRED SERVICE AND/OR MAINTENANCE COULD RESULT IN THE LOSS OF WARRANTY. THE OWNER SHOULD REVIEW HOLIDAY RAMBLER CORPORATION'S LIMITED WARRANTY AND THE LIMITED WARRANTIES OF ALL OTHER MANUFACTURERS OFFERING THEM THAT ARE APPLICABLE TO THIS VEHICLE.

INSTRUCTIONS ARE INCLUDED IN THE MANUAL FOR OPERATING SOME COMPONENTS WHICH ARE OPTIONAL ON SOME VEHICLES IN ADDITION, THE OWNER SHOULD REFER TO INDIVIDUAL MANUFACTURER'S OPERATING INSTRUCTIONS CONTAINED IN THE OWNER'S PACKET AS INDICATED.

HOLIDAY RAMBLER CORPORATION®

Wakarusa, Indiana 46573

DIRECTORY

Welcome to the Holiday Rambler Family	2
Customer Relations, Taking Delivery, Obtaining Service	
Vehicle Identification	7
Monitor Panels, Dashboard,	
Safety Precautions	15
Checklist, Vehicle Loading, Smoke Detector, Safety Belt	
Towing, Leveling, Stabilization	25
Towing, Lifting, Rear Hitch, Leveling Jacks	
Electrical	33
General System, Batteries, 12 Volt Disconnect, Invertor, Ground Fault Circuit Breaker	
LP Gas	43
General System, LP Gas Leak Detector, Liquid Propane Gas Detec- tor/Alarm	
Appliances	53
Refrigerators, Microwave, Range Top, Furnace, Water Heater, Ice Maker	
Equipment	73
Generator, Air Conditioner, Kool-O-Matic Attic Fan, Awning, Alarm Sys- tem, TV Antenna, Cruise Control, Intec, Power Seat, Electric Step, Dinette Seat	
Water System	87
Fresh Water, Disinfecting, Water Purifier, Waste System, Toilet, Winteriz- ing	
Interior/Exterior Care	97
Exterior, Interior Components	
Vehicle Maintenance	103
Chassis Info, Bulb Chart, BTU Chart, Holding Capacities, Fuse Charts, Maintenance Charts, Winter Storage, Serial Numbers	
Holiday Ramblers Recreational Vehicle Club	119

CUSTOMER RELATIONS

Only by keeping your confidence and satisfaction with our product and service can we insure our continued success as a manufacturer of family camping vehicles. We've found that maintaining a cordial and effective relationship with our customers is just as important as improving the technical excellence of our products. Your authorized dealer is pleased to help you with service and instructions about your camping vehicle.

Most problems arise from misunderstandings about warranty or service and usually can be solved by the dealer. If the problem remains after you have consulted your dealer, you're invited to contact our Consumer Affairs Department. We will work with the dealer and see that every attempt to resolve the matter is made.

Write or call:

Consumer Affairs Department

Holiday Rambler Corporation

65528 State Road 19

Wakarusa, Indiana 46573

219/862•7278

Please have all pertinent information (serial numbers, model numbers, etc.) when writing us. You will find space to list them all at the back of this manual.

TAKING DELIVERY

Your camping vehicle has been inspected by factory personnel throughout the manufacturing process. Our final factory check by quality control inspectors is not the last one. Your dealer performs additional pre-delivery inspections and systems checks, and helps you understand the Limited Warranty and complete any necessary forms.

Dealer responsibilities include:

1. Orienting the customer to the family camping vehicle, its systems and components, and their operation.
2. Insuring the customer receives a complete Owner's Packet with warranty cards and registrations for the camping vehicle and for separately warranted products, including operating and maintenance instructions.
3. Reviewing Limited Warranty provisions with the customer, stressing the importance of mailing warranty cards and registrations to the manufacturers within the prescribed time limits to avoid loss of Limited Warranty coverage. Assisting the customer in completing these forms if he wishes. Requesting that the customer read all warranty information as soon as possible explaining any provisions not clearly understood.
4. Instructing the customer how to get local service and out-of-town service on the camping vehicle and its separately warranted components, either in or out of warranty.

Customer responsibilities:

As a new family camping vehicle owner, you have the responsibility for regular and proper maintenance. This will help you avoid conditions arising from neglect that are not covered by your Holiday Rambler Corporation Limited Warranty. Maintenance services should be performed in accordance with this Owner's Manual, the chassis Owner's Manual, and any other applicable manuals.

As the owner, it is your responsibility and obligation to return the camping vehicle to an authorized dealer for repairs and service (SEE LIMITED WARRANTY).

Since the Authorized Dealer from whom you purchased your new camping vehicle is responsible for its proper servicing before delivery, and has an interest in your continued satisfaction, we recommend that INSPECTION, WARRANTY AND MAINTENANCE SERVICES be performed by him.

We suggest that you take your new family camping vehicle on a weekend "shakedown" before leaving on an extended trip.

SUGGESTIONS FOR OBTAINING SERVICE FOR YOUR RV

Give Thought to the Appointment Time...

Know when to take your RV in for service. Monday and Friday are busy days at most dealers. Therefore, it makes sense to make a mid-week appointment whenever possible.

Prepare for the Appointment...

If you're having warranty work done, be sure to have your warranty card with you. All work to be performed may not be covered by the warranty; discuss additional charges with the service manager. Keep a maintenance log of your vehicle's service history. This can often provide a clue to the current problem.

Prepare a List...

Make a written list of your RV's problems or the specific work you want done. If you've had an accident or work done that is not on your maintenance log, let the service manager know. Don't keep secrets.

Be Reasonable with Your Requests...

Don't leave a list of twenty items to be serviced and expect to have your RV back by five o'clock. If you list a number of items and you must have your RV by the end of the day, discuss the situation with the service manager and list your items in order of priority. Expect to make a second appointment for work not completed or for parts that may need to be ordered.

You Can't Look over the Technician's Shoulder...

Don't be offended when you are told you can't watch the work being done. Insurance requirements forbid the admission of customers to a service repair area.

Inspect the Work Properly...

Check out the service or repair job when you pick up your RV and notify the Service Manager of any dissatisfaction. If circumstances prevent returning for immediate corrective work, make an appointment for as early a date as possible or practical.

NOTES

Lined paper for notes, featuring horizontal ruling lines across the page.

VEHICLE IDENTIFICATION

Monitor Panels	8
Instrument Clusters	
25' Aluma-Lite Class A	10
Aluma-Lite & XS Class A	11
Aluma-Lite Ford (F-53) Class A	12
Imperial Class A	13
Imperial 37CBXS Class A	14

MONITOR PANELS

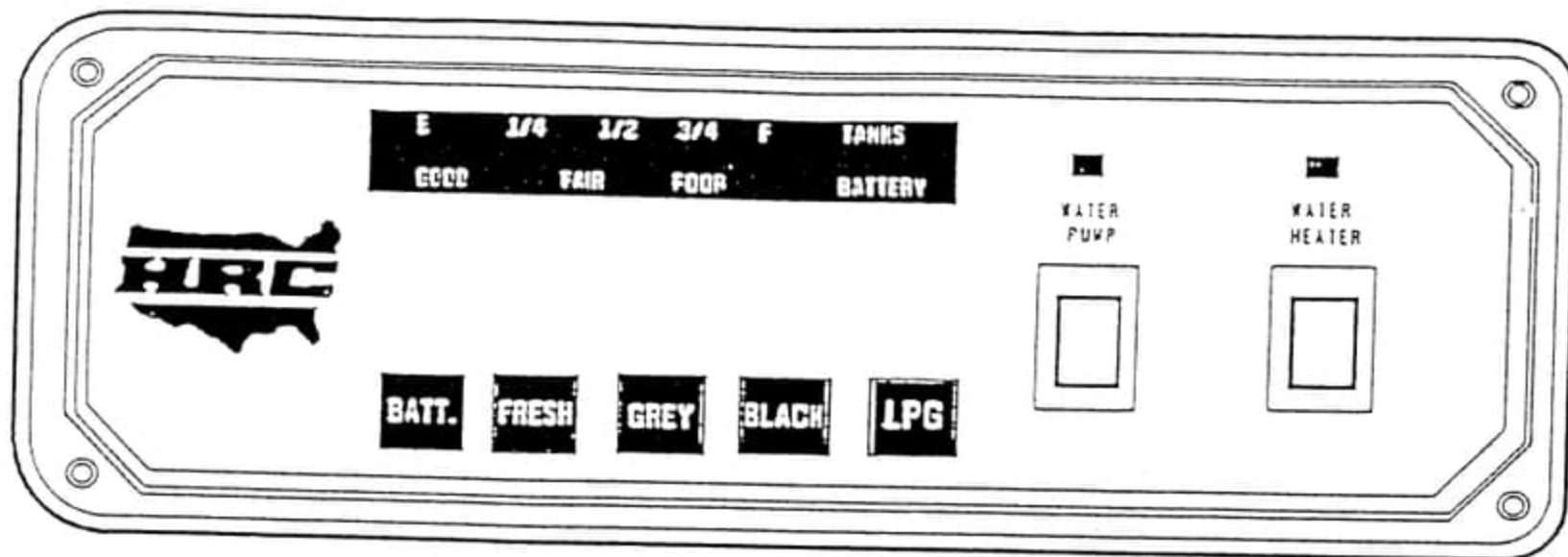

Standard Monitor Panel

1. Water Heater Indicator
2. Water Pump Indicator
3. Battery and Tank Indicators
4. Water Heater Switch
5. Water Pump Switch
6. L.P. Test Button
7. Black Water Test Button
8. Grey Water Test Button
9. Fresh Water Test Button
10. Battery Test Button

Monitor Panel Functions

WATER HEATER INDICATOR: When the water heater switch is turned on the indicator light should flash red for a few seconds, then turn green. If the flame goes out the indicator will flash red.

PUMP INDICATOR: This switch activates the water pump. **PUMP** light comes on when water pump switch is on. The pump and indicator may also be activated by a switch located in the bathroom.

BATTERY: A momentary-on switch gives the battery condition.

FRESH, GREY, BLACK, LPG TEST: A momentary-on switch giving a read out of tank levels. The tanks will read empty, low (1/4), medium (1/2), or full (3/4), or full at the time of the test.

MONITOR PANEL

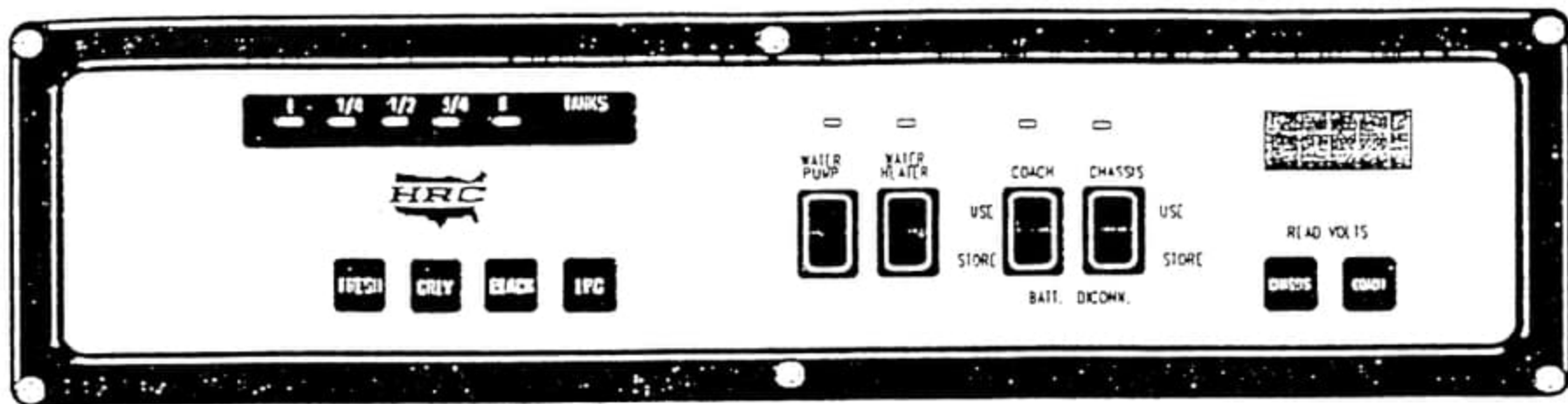

Monitor Panel w/Optional Battery Disconnect

1. Water Pump Indicator & Switch
2. Water Heater Indicator & Switch
3. Tank Indicators
4. Fresh Water Test Button
5. Grey Water Test Button
6. Black Water Test Button
7. L.P. Test Button
8. Battery Test Buttons, Chassis and Coach
9. Battery Disconnect

Monitor Panel Functions

WATER HEATER INDICATOR: When the water heater switch is turned on the indicator light should flash red for a few seconds, then turn green. If the flame goes out the indicator will flash red.

PUMP INDICATOR: This switch activates the water pump. **PUMP** light comes on when water pump switch is on. The pump and indicator may also be activated by a switch located in the bathroom.

BATTERY: A momentary-on switch gives the battery condition.

FRESH, GREY, BLACK, LPG TEST: A momentary-on switch giving a read out of tank levels. The tanks will read empty, low (1/4), medium (1/2), or full (3/4), or full at the time of the test.

ALUMA-LITE 25' CLASS A INSTRUMENT PANEL

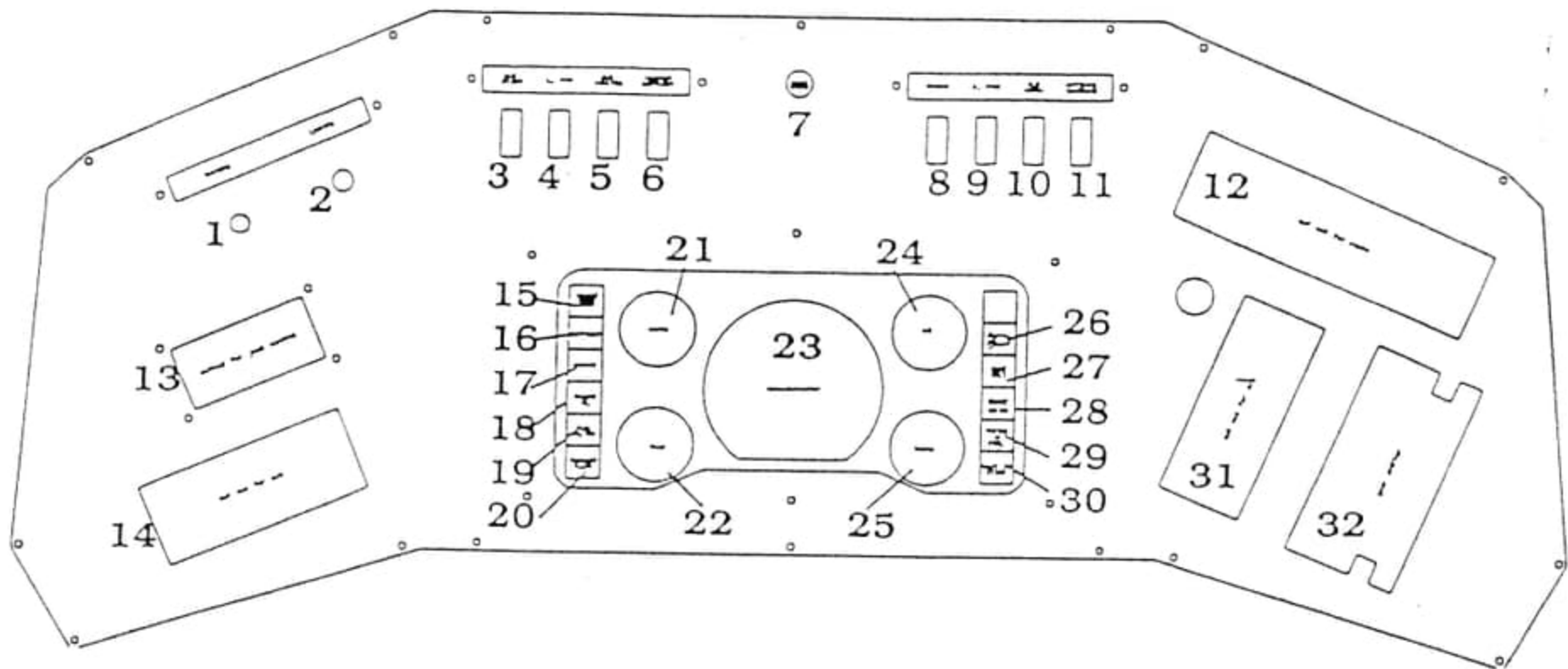

Instrument Panel Legend

- | | |
|-------------------------------|---------------------------------------|
| 1. Windshield Wiper Switch | 17. Engine Indicator |
| 2. Headlight Switch | 18. Check Oil Indicator |
| 3. Aux. Start Switch | 19. Fuel Filter |
| 4. Left Defrost Fan Switch | 20. Check Windshield Washer Fluid |
| 5. Auxiliary Heater Switch | 21. Chassis Battery Voltage Indicator |
| 6. Mirror Defrost Switch | 22. Fuel Gauge |
| 7. Check Engine Indicator | 23. Speedometer |
| 8. 3-Way Radio Switch | 24. Oil Pressure Gauge |
| 9. Right Defrost Fan Switch | 25. Engine Temperature Indicator |
| 10. Auxiliary Horn Switch | 26. Hi-Beam Indicator |
| 11. Antenna Warning Indicator | 27. Seat Belt Indicator |
| 12. Radio | 28. Emergency Brake Indicator |
| 13. Leveling Jack Controls | 29. Water In Fuel |
| 14. A/C Vent Louver | 30. Wait to Start |
| 15. Service Engine Soon | 31. A/C Vent Louver |
| 16. Battery Indicator | 32. Gear Shift |

ALUMA-LITE CLASS A INSTRUMENT PANEL

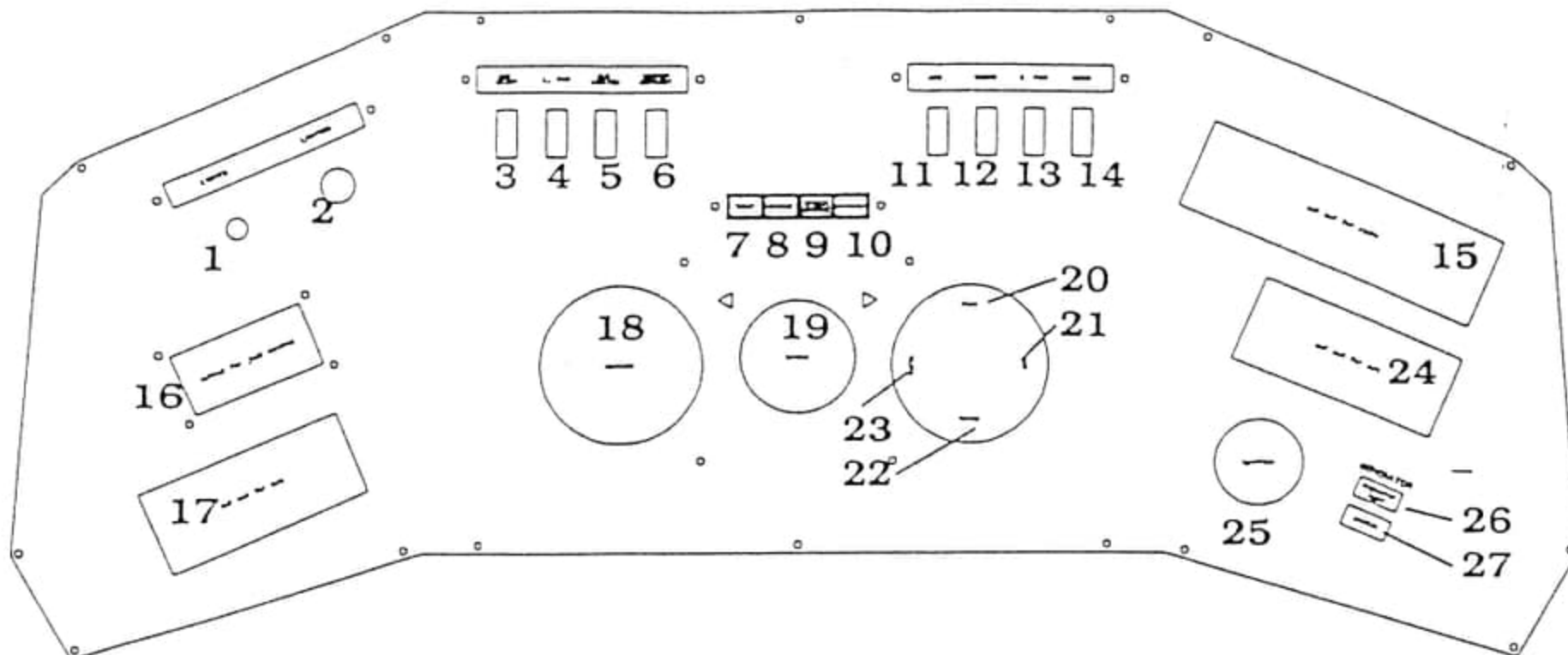

Instrument Panel w/o Instrument Cluster

- | | |
|---------------------------------|-------------------------------|
| 1. Headlight Switch | 15. Radio |
| 2. Cigarette Lighter | 16. Leveling Jack Controls |
| 3. Auxiliary Start Switch | 17. A/C Vent Louver |
| 4. Left Defrost Fan Switch | 18. Speedometer |
| 5. Auxiliary Heater Switch | 19. Emergency Brake Indicator |
| 6. Mirror Defrost | 20. Fuel Gauge |
| 7. Engine Temperature Indicator | 21. Oil Pressure Gauge |
| 8. Choke Indicator | 22. Engine Temperature Gauge |
| 9. Check Engine Indicator | 23. Chassis Battery Voltage |
| 10. Antenna Warning | 24. A/C Vent Louver |
| 11. Accessory Switch | 25. Ignition |
| 12. 3-Way Radio Switch | 26. Generator Indicator Light |
| 13. Right Defrost Fan Switch | 27. Generator Switch |
| 14. Horn Switch | |

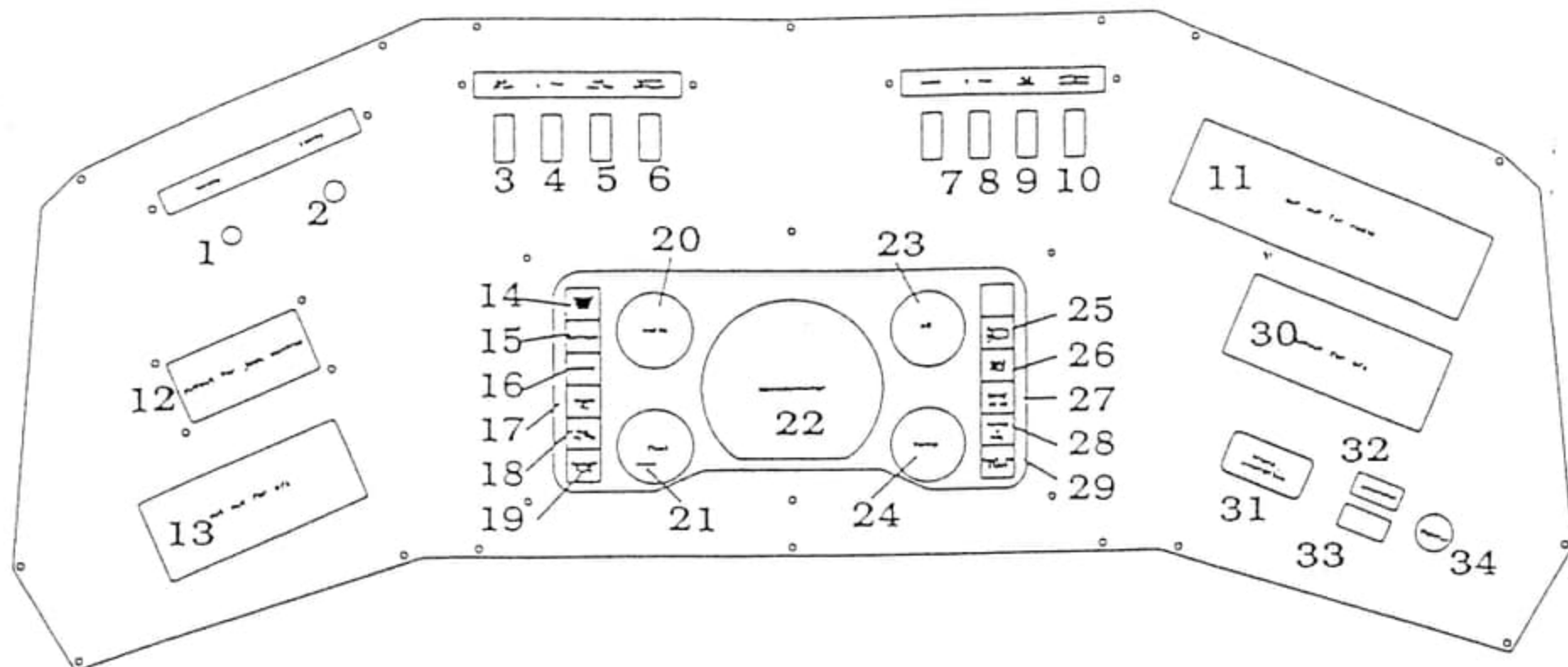

- | | |
|-------------------------------|---------------------------------------|
| 1. Windshield Wiper Switch | 17. Check Oil Indicator |
| 2. Headlight Switch | 18. Fuel Filter |
| 3. Aux. Start Switch | 19. Check Windshield Washer Fluid |
| 4. Left Defrost Fan Switch | 20. Chassis Battery Voltage Indicator |
| 5. Auxiliary Heater Switch | 21. Fuel Gauge |
| 6. Mirror Defrost Switch | 22. Speedometer |
| 7. 3-Way Radio Switch | 23. Oil Pressure Gauge |
| 8. Right Defrost Fan Switch | 24. Engine Temperature Indicator |
| 9. Auxiliary Horn Switch | 25. Hi-Beam Indicator |
| 10. Antenna Warning Indicator | 26. Seat Belt Indicator |
| 11. Radio | 27. Emergency Brake Indicator |
| 12. Leveling Jack Controls | 28. Water In Fuel |
| 13. A/C Vent Louver | 29. Wait to Start |
| 14. Service Engine Soon | 30. A/C Vent Louver |
| 15. Battery Indicator | 31. Transmission Overdrive |
| 16. Engine Indicator | 32. Generator Indicator |
| | 33. Generator Switch |
| | 34. Ignition |

IMPERIAL CLASS A INSTRUMENT PANEL

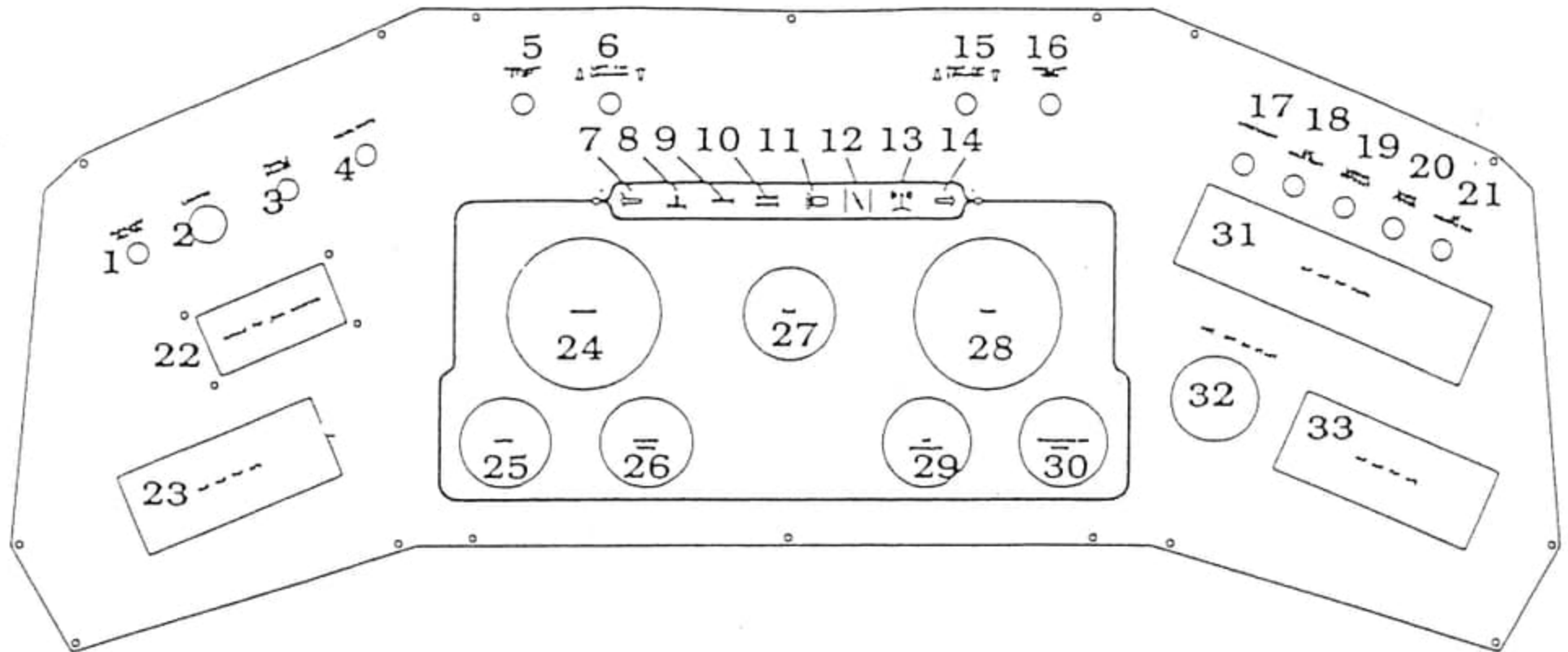

- | | |
|---------------------------------|------------------------------------|
| 1. Auxiliary Heater Switch | 18. ICC Courtesy Lights |
| 2. Cigarette Lighter | 19. Mirror Defrost |
| 3. Toggle Switch Dimmer | 20. 3-Way Radio Switch |
| 4. Headlight Switch | 21. AC Generator Switch |
| 5. Auxiliary Start Switch | 22. Leveling Jack Controls |
| 6. Left Defrost Fan Controls | 23. A/C Vent Louver |
| 7. Left Turn Indicator | 24. Speedometer |
| 8. Engine Temperature Indicator | 25. Chassis Battery Voltage Gauge |
| 9. Emergency Brake Indicator | 26. Engine Temperature Gauge |
| 10. Check Engine Indicator | 27. Fuel Gauge |
| 11. Headlight Bright Indicator | 28. Tachometer |
| 12. Choke | 29. Oil Pressure Gauge |
| 13. Antenna Warning | 30. Transmission Temperature Gauge |
| 14. Left Turn Indicator | 31. Radio |
| 15. Right Defrost Fan Switch | 32. Ignition |
| 16. Auxiliary Horn Switch | 33. A/C Vent Louver |
| 17. Accessory | |

IMPERIAL 37CBXS CLASS A INSTRUMENT PANEL

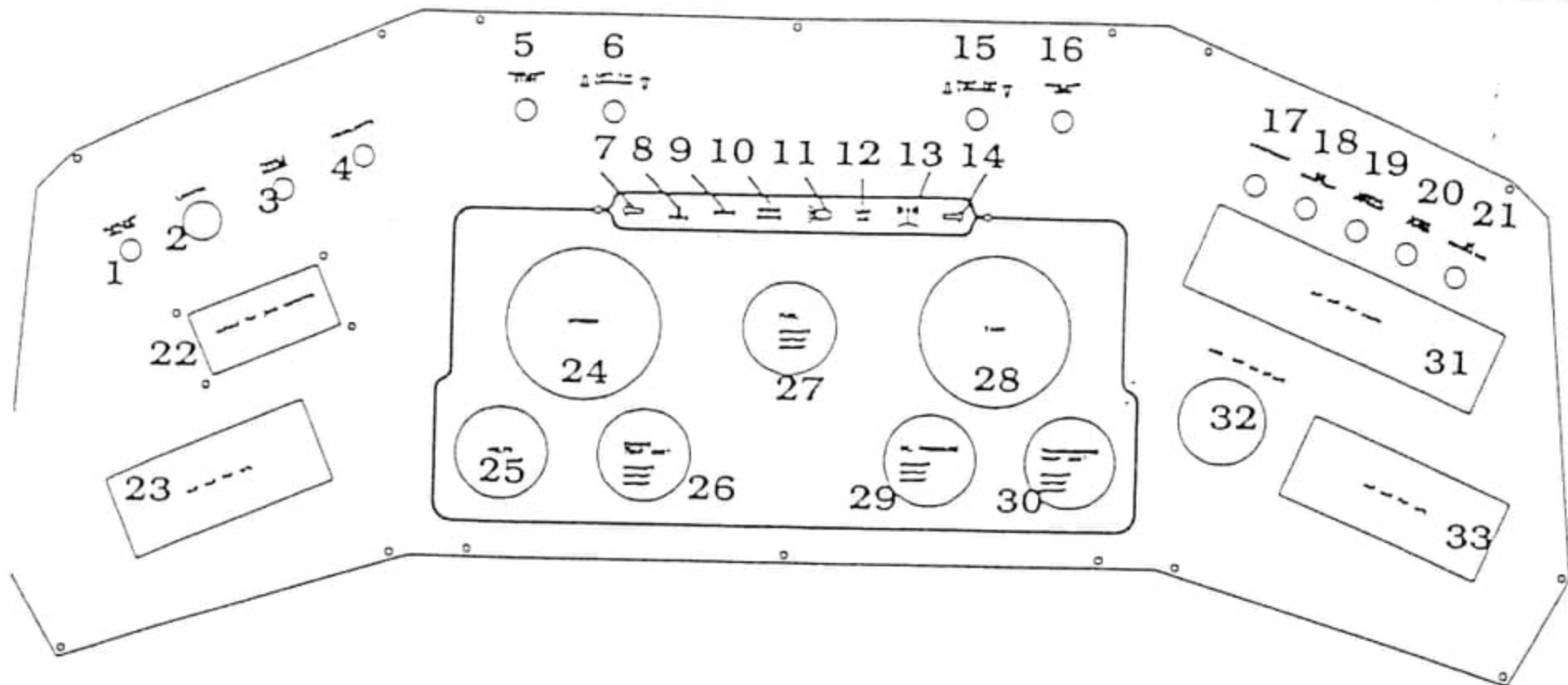

Instrument Panel w/o Instrument Cluster

- | | |
|--------------------------------|------------------------------------|
| 1. Aux. Heater Switch | 18. ICC Courtesy Lights |
| 2. Cigarette Lighter | 19. Mirror Defrost Switch |
| 3. Toggle Switch Dimmer | 20. 3-Way Radio Switch |
| 4. Headlight Switch | 21. AC Generator |
| 5. Auxiliary Start Switch | 22. Leveling Jack Controls |
| 6. Left Defrost Fan Switch | 23. A/C Vent Louver |
| 7. Left Turn Indicator | 24. Speedometer |
| 8. Engine Temperature | 25. Chassis Battery Voltage Gauge |
| 9. Emergency Brake Indicator | 26. Engine Temperature Gauge |
| 10. Check Engine Indicator | 27. Fuel Gauge |
| 11. Hi-Beam Indicator | 28. Tachometer |
| 12. Low Air Pressure Indicator | 29. Oil Pressure Gauge |
| 13. Antenna Warning Indicator | 30. Transmission Temperature Gauge |
| 14. Right Turn Indicator | 31. Radio |
| 15. Right Defrost Fan Switch | 32. Ignition |
| 16. Auxiliary Horn | 33. A/C Vent Louver |
| 17. Accessory | |

SAFETY PRECAUTIONS

Pre-travel Checklist	16
Ready to Leave	19
Backing In	19
Tires	19
Vehicle Loading	20
Smoke Detector	21
Fire Extinguisher	22
Safety Seat Belt	23
Infant & Child Restraints	23
Emergency Stopping	24
Egress Window	24
Safety Seat Belt	23
Infant & Child Restraints	23

PRE-TRAVEL SAFETY CHECK LIST

Before each trip your motorhome should be given a thorough safety check. The following list is provided for your safety and may eliminate any personal injury or damage to your vehicle.

EXTERIOR CHECK LIST

- Remove the wheel blocks
- Check "Cold" tire pressure, remember the spare. (Cold=Ambient Temperature)
- Check the lug nuts; tighten as required.
- Adjust mirrors
- Clean and repack the wheel bearings according to the manufacturer's specifications in the chassis owner's manual.
- Check transmission fluid level.
- Check power steering fluid level.
- Check radiator coolant level.
- Check oil level in engine and generator.
- Check windshield wipers.
- Check running lights.
- Check emergency brakes.
- Unhook 110V power cord and stow.
- Unhook water hose and stow.
- Fill the LP Gas tank and turn off the valve.
- Fill water tank, but guard against contamination. (Fill instructions are in the water system section.)
- Be certain entrance step is in the up position.

NOTE: When storing items in compartments, remember they are not waterproof.

INTERIOR CHECK LIST

- Lock refrigerator doors.
- Close all windows and vents.
- Secure all loose articles.
- Turn off lights and appliances.
- Lock doors.
- Keep the fire extinguisher handy. Have it inspected regularly for proper charge.
- Raise leveling jacks (if equipped).
- Avoid overloading (see GVWR in Safety section).
- Distribute load carefully (see Safety section).
- Test the brakes in a safe area, NOT on a highway.
- Use safety belts for both the driver's and the passenger's safety.
- Observe the warning labels for all systems. (including LP, Elec., and Refueling.)

NOTE: Make sure that all items on the inside of the unit are secured or stowed away while in transit.

NOTE: Your unit is equipped with a dead-bolt lock, we suggest it be used in conjunction with the regular door lock, whenever you are in transit as an extra measure of protection.

HOME

- Leave house key with a neighbor
- Store valuables and important papers in a safe place
- Discontinue newspaper, milk and other deliveries.
- Ask the post Office to hold your mail.
- Place matches in a tin box or glass jar - avoid fire hazards.
- Have your lawn, garden and house-plants cared for.
- Cover all food to keep ants, mice & insects out.
- Store oil, gasoline and other flammables properly.
- Notify Police

Operating your new camping vehicle may be an unfamiliar experience for you. Use extra caution until you feel comfortable behind the wheel.

As you approach a hill, accelerate a bit more than usual. Do not be afraid to downshift, even with an automatic transmission. If it takes a lower transmission gear to climb a low or steep grade, then descend in the same gear.

You should have little difficulty on gradual turns. For sharper turns, it is helpful if you reduce your speed and be aware of obstacles located close to the curb or roadway.

Proper braking is extremely important to your safety. Your motorized vehicle weighs much more than most automobiles or small trucks that you are probably used to driving. Anticipate traffic signals, signs and side traffic. Decelerate slowly, whenever possible, to conserve fuel and prevent undue wear on the brakes, tires, etc.

Other Precautions

- Never exceed the posted speed limits; adjust speed according to weather, traffic or road conditions.
- Use extreme caution when going downhill. Excessive speed could cause a loss of control.
- Never attempt to pass on a curve or anywhere you do not have an unobstructed view of the road ahead.
- Know and observe the laws where you will be traveling as they may vary from state to state.

Parking

- Level and block all four wheels securely.
- Level the coach with the automatic leveling jacks.
- Connect the 110V/220V power.
- Open the valve at the LP Gas tank.
- Connect the fresh water supply
- Connect the waste drain hose.
- Start the refrigerator.
- Start the water heater.
- Start the furnace, if needed.
- Light oven and range pilots.
- Sanitize the water system, if necessary.

WARNING: Do not use the gearshift selector in place of the parking brake. Always set the parking brake fully AND make sure the gearshift selector is latched in P (PARK).

Backing In

If your destination doesn't have drive-through sites, pick a good level spot and back in carefully. We suggest:

- Stop near the site; get out and look it over. Check it for low hanging tree limbs, posts, large rocks or other obstacles.
- Try to place the site so it is on the driver's left, so you can see what the rear of the unit is doing. With the site on the door side (passenger side), you would be backing on your blind side, which is more difficult even with the side mirrors as a guide.
- If everything is clear, then maneuver the vehicle into position for backing into the space.
- Back up slowly, using the side mirrors as a guide or have another person outside to help guide you safely.
- Use the back-up monitor.

READY TO LEAVE

The following suggestions may be helpful when you are ready to leave.

Starting and Warmup

For best results, follow the recommendations in your chassis Operator's Manual when starting or operating your engine.

NOTE: Be sure transmission is in the "P" (park) position and that the parking brake is engaged to keep the motorhome from rolling. If the parking brake needs adjustment, see the chassis Operator's Manual for adjustment instructions.

TIRES

The chassis manufacturer equipped your vehicle with tires rated for highway speeds at the GVWR. Inflate "cold" to recommended pressure found on tire sidewall. Check often when traveling. Don't overload.

Tires are covered by the tire manufacturer's warranty. If you have a defective tire, go directly to the nearest tire dealer for replacement according to the applicable warranty. Never discard a defective tire; return it to the tire dealer for inspection.

VEHICLE LOADING

Gross Vehicle Weight Rating (GVWR)

Your motorized vehicle's GVWR is printed on the Federal Manufacturer's Certification Label which is located on the sidewall next to the driver's seat. This number represents the unit's maximum safe weight, including the vehicle itself, and all additional cargo and passengers. **IT IS IMPORTANT THAT THIS WEIGHT NOT BE EXCEEDED WHEN LOADING YOUR MOTORIZED UNIT.**

Gross Axle Weight Rating (GAWR)

Your motorized vehicle's GAWR is found on the same federal tag. This number represents the maximum safe loading for each axle and must be considered in distributing weight as evenly as possible. It is extremely important not to exceed this weight for each axle. Overloading either in front of or behind axles can result in adverse handling characteristics.

Cargo Capacity

Cargo capacity is the additional weight, over and above the vehicle's own dry weight, which can be carried safely without exceeding the Gross Vehicle Weight Rating. It includes passengers, personal belongings, water and LP gas. To find your vehicle's cargo capacity, subtract the dry weight (found on the Certificate of Origin) from the Gross Vehicle Weight (found on the Federal tag on the dash or door post). From this figure, subtract the weight of the fluids (water and LP gas) to find the net cargo capacity. This is the amount of passengers' weights and personal items that can be carried safely.

CAUTION: It's also important to load personal cargo so that the Gross Axle Weight Ratings are never exceeded. For safety's sake, you should weigh your family camping vehicle frequently as loaded for travel. We can not emphasize too strongly that the Gross Vehicle Weight and Axle Rating **MUST NOT BE EXCEEDED.**

NOTE: When traveling, we recommend not to have the waste water holding tanks more than 1/2 full.

SMOKE DETECTOR

General

Statistics show that most fire casualties are not caused by direct flame, but by the less visible smoke (products of combustion). The detector responds to both visible and invisible products of combustion.

The detector will automatically return from the Alarm to the Normal state when the reason for activation, the presence of smoke, is completely removed.

Operation: How to Test

To test the electronics of the alarm, press the test button on the cover of the smoke alarm for a few seconds. The smoke alarm will sound by making a continuous loud "beep". To complete the test sequence release the button and the alarm should stop.

To test that the smoke is able to reach the ionization/sensing chamber you must blow smoke into the sensing chamber, in a careful, firesafe manner, until the alarm sounds. Do not use an open or direct flame of any kind, or you may damage your detector or your motorhome. The smoke alarm will stop sounding once the smoke has cleared the ionization chamber.

NOTE:When installed in recreational vehicles, test smoke alarm operation after vehicle has been in storage, before each trip, and at least once per week during use.

Battery Replacement

The Eveready 216, 522, 1222, Duracell MN1604, Mallory MN1604 and Gold Peak 1604P are the only acceptable batteries for use in the smoke alarm. The battery will power the smoke alarm for at least one year under normal use. When the battery reaches the end of its normal life a low battery warning (intermittent beeping) will indicate the need for battery replacement, for up to 30 days.

Maintenance

Vacuum the slots in the cover and sides, with the soft brush attachment every month. Your smoke alarm should be cleaned every six months to help keep the unit working efficiently.

Problems are indicated by three events:

1. The alarm does not sound upon pressing the test button.
2. The alarm does not sound with the smoke test

Try the Following:

1. Inspect for obvious damage.
2. Check that the unit contains recommended battery type.
3. Check that the battery is properly connected, or replace the battery if needed.
4. Gently vacuum as recommended above.

If these procedures do not correct the problem, DO NOT attempt repairs. If the smoke alarm is within warranty period and terms, indicate the nature of the problem and return the unit with proof of purchase to the distributor. Units beyond warranty cannot be economically repaired.

False Alarms:

Abnormal air conditions may cause the highly sensitive smoke alarm to give a "false" alarm. If no fire is apparent, ventilate the room and/or blow fresh air into the unit until the alarm stops. Once cleared, the smoke alarm will automatically reset. Dust can lead to excess sensitivity. Vacuum as recommended above.

DO NOT PAINT THE DETECTOR.

CAUTION: There is no way to guarantee against injury or loss of life in a fire; however, this smoke detector is intended to help reduce the risk of tragedy. Additional smoke detectors may further help to reduce the risk. This detector may not save your life from careless practices.

Three of the most common fire killers are:

- Smoking in bed
- Leaving children unattended
- Cleaning with flammable fluids

Please, be safety conscious and avoid unnecessary risk!

FIRE EXTINGUISHER

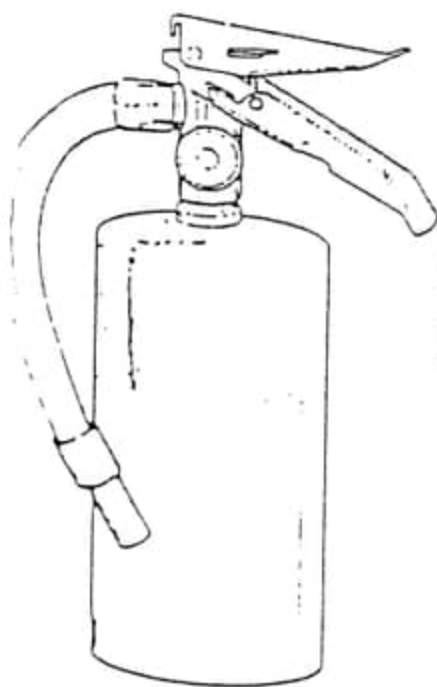

The fire extinguisher in your unit is located near the main entrance door.

Please read the operating instructions that are printed on the fire extinguisher, if there is any doubt on the operation you and your family should practice, then replace or recharge the extinguisher.

SAFETY SEAT BELTS

Seat belts are an important safety feature of your vehicle. For your protection, fasten all seat belts while your motorhome is in motion. The driver's seat and all other seats designed to carry passengers while under way have been equipped with lap belts.

NOTE:All occupants should be furnished with and use seat belts while the vehicle is in motion. Do not occupy the beds while traveling as safety protection is not provided.

Adjust your seat belt as follows:

- Pivot the buckle at right angles to the belt and pull to desired length.
- To fasten belt, be sure the belt is not twisted, then push the tongue into the buckle of the mating belt. Be sure it latches. Pull the loose end of the belt to tighten.
- To release the belt, depress the button in the center of the buckle and slide the tongue out of the buckle.

Adjust the belt as low on the abdomen and as snugly as comfort will allow, for greatest safety. Never use a belt for more than one person at a time.

INFANT AND CHILD RESTRAINTS

WARNING:For maximum protection in your unit children should not be transported unrestrained. Infants should be placed in infant carriers. Small children should be restrained in child safety seats. These seats should be placed in the vehicle in accordance with the instructions with the seat or infant carrier.

EMERGENCY EXIT WINDOW

The emergency exit window in your unit can be easily identified by the RED color of the handle. Operation of this window can be accomplished in the following manner.

Slider Windows

1. Pull forward on the RED handle to release the latching mechanism.
2. Slide the window open.
3. Slide screen open if present.

The window operation should be checked before each trip.

When at campsite make sure you have not parked in such a manner that blocks the exit window. Park away from trees, steep cliffs and other items that may prevent a safe escape.

EMERGENCY STOPPING

Always carry road flares or reflective warning signs to display, if necessary. Pull off the roadway as far as possible for emergency stopping or tire changing. Turn on your vehicle hazard warning flashers when parked alongside traffic lanes. Set parking brake.

TOWING, LEVELING AND STABILIZING

- Towing 26
 - Towing Procedures 26
- Mini Home 26
- 25WB Class A 26
- Chevy Class A 27
 - Jacking Instructions 28
- Mini Home and 25' Class A 28
- Motorhome 28
 - Front Axle 28
 - Rear Wheel 28
- Power Leveling Jacks 29

TOWING

If your motorhome ever needs to be towed, please follow these instructions:

- Secure any loose or protruding parts of the damaged vehicle.
- Inspect points of attachment to the disabled vehicle. If attachment points are damaged, select other attachment points at a substantial frame structural member.
- Never allow anyone to go under a vehicle while it is being lifted by towing equipment unless the disabled vehicle is adequately supported by safety stands.

Do not tow the motorhome from the rear. Towing from the rear will cause the front tires and suspension to be seriously overloaded, possibly resulting in tire or front suspension failure. The rear frame extensions are not designed to withstand the loads imposed by lifting from the rear.

If the rear wheels are disabled, place the motorhome on a flat bed trailer, or use a heavy duty dolly under the rear wheels and tow from the front.

Towing Procedure For Mini Homes

1. Attach "J" hooks to the inboard ends of the lower control arms.
2. Position a 4 x 4 length of wood across hitch chains just behind the bumper.
3. Attach safety chains which are completely independent of the primary lifting and towing attachment around the frame side rails.
4. Lift the vehicle until the wheels are a minimum of 4" off the ground. Be sure there is adequate ground clearance at the rear of the vehicle.

The vehicle may be towed on the rear wheels with the parking brake released and the transmission in neutral providing a speed of 35 mph and a distance of 50 miles is not exceeded. If this speed or distance must be exceeded, disconnect the drive shaft or place the rear wheels on a dolly.

IN ANY EVENT, DO NOT TOW ANY VEHICLE AT SPEEDS OVER 35 MPH.

The safety of the operator and all others in the vicinity of the wrecker and the towed vehicle must be considered at all times during a towing operation. **DO NOT ALLOW ANY PERSON TO RIDE IN THE TOWED VEHICLE.** Safe operating speeds depend on weather, road, traffic, visibility conditions, and the condition of the towed vehicle. Avoid panic stops. Obey all state and local laws regarding items such as warning signals, night illumination, speed, etc.

Towing 25WB Class A

Towing from the Front

If the vehicle is to be towed for an extended distance (more than 2 miles), you must disconnect the drive shaft. Failure to do so will result in damage to the transmission, due to lack of lubrication.

1. Unbolt the front bumper and remove.
2. Wrap chains around the front axle and pass them beneath the tow bar below the bumper.
3. Position a 6 x 6 timber between the ends of the main frame rails and tow vehicle transfer plate to maintain clearance to body parts.
4. Raise the wheels at least 4 inches off the ground.
5. **IMPORTANT:** Attach safety chains to the main frame rails, which are completely independent of the primary lifting device.
6. When vehicle is under tow, allow enough room between the front of the motorhome and the rear of the tow vehicle while turning corners.

Towing Chevy Class A

1. Remove the front bumper and spoiler by unbolting at the front and sides.
2. Wrap chains around both A-arms on each side. Pass chains completely around A-arm, not through the center.
3. Pass the chains beneath the tow bar below the bumper.
4. Position a 6 x 6 timber between the ends of the main frame rails and the tow vehicle transfer plate to maintain clearance to body parts.
5. **IMPORTANT:** Attach safety chains which are completely independent of the primary lifting device to the main frame rails.
6. When vehicle is under tow, allow enough room between the front of the motorhome and the rear of the tow vehicle while turning corners.

Towing a 37CBXS Class A

Towing from the Front

1. Unbolt the front bumper and spoiler at the front and the sides.
2. Wrap chains around the front suspension and pass them beneath the tow bar below the bumper.
3. Position a 6 x 6 timber between the ends of the main frame rails and the tow vehicle transfer plate to maintain clearance to the body parts.
4. Lift the wheels at least 4 inches of the ground.
5. **IMPORTANT:** Attach safety chains to the main frame rails which are completely independent of the primary lifting device.
6. When vehicle is under tow, allow enough room between the front of the motorhome and the rear of the tow vehicle while turning corners.

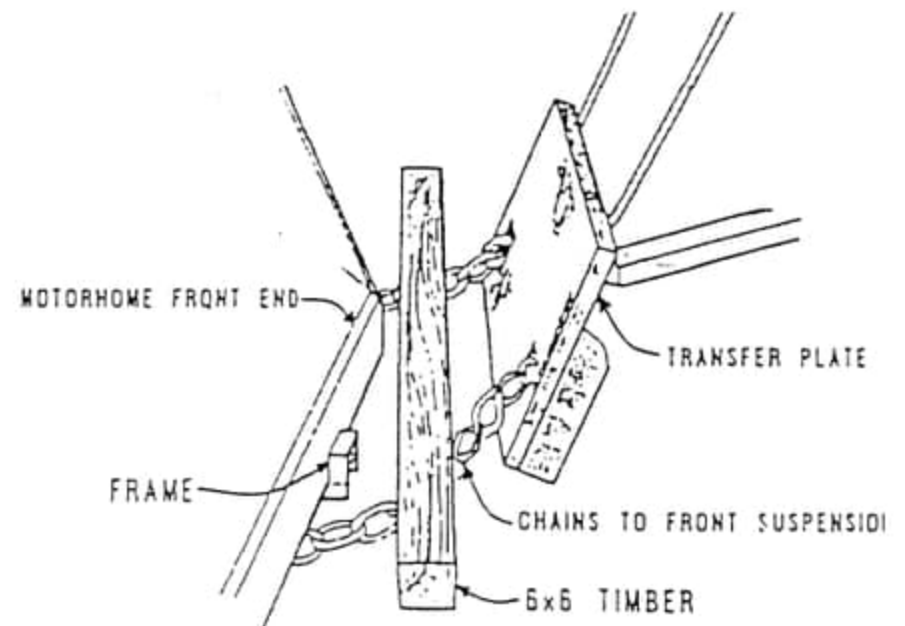

JACKING INSTRUCTIONS MINI HOME & 25' CLASS A

1. Set parking brake.
2. Block the wheels on the opposing side.
3. To raise front wheels, place jack in position from side of vehicle under axle arm 3 to 6 inches inboard of the radius arm attaching bolt.
4. To raise rear wheels, place jack in position under the rear axle between the U-bolts or under U-bolt bracket.

MOTORHOME JACKING PROCEDURE

WARNING: The jack is designed for use as a tool for changing tires only. Jack the vehicle on a level surface only. Never go under the motorhome while vehicle is jacked up.

1. Turn off the engine, place transmission in PARK and set the parking brake.
2. Block both the front and back of the opposing wheel to be removed.

WARNING: Soft ground will not support the vehicle when jacked.

Front Axle

1. Screw jack extension out to approximate ground-to-spring height.
2. Slide jack under axle and begin jacking until jack is loaded, but **DO NOT** jack tire off ground.
3. Loosen the wheel nuts with a lug wrench.
4. Resume jacking until the wheel is free of ground.
5. Remove the wheel nuts and wheel put spare wheel in place.
6. Install the wheel nut and tighten as much as possible with the wheel and tire off ground.
7. Lower jack until tire contacts ground. Tighten nuts with lug wrench in recommended sequence.
8. Finish lowering and remove jack and blocks.

NOTE: Stop at the nearest service facility and have torque on wheel nuts checked.

Rear Wheel

1. Screw the jack extension out to approximate ground-to-axle housing tube height.
2. Place jack under axle housing. Center the jack on the housing so that the vehicle will not slide off the jack. Place the jack far enough inboard on the axle housing so that when the handle is inserted, the jack may be operated from either in front or behind the tire without getting under the vehicle.
3. Start jacking but do not lift wheel and tire off ground.
4. Loosen wheel nuts with lug wrench.

5. Resume jacking until wheel and tires are free of the ground. **DO NOT CRAWL UNDER VEHICLE!**

6. Remove wheel nuts and wheel, put spare wheel in place.

7. Replace wheel nuts and torque in recommended sequence.

Note: Full torque must be applied to dual rear wheel nuts with both wheels off the ground.

8. Lower jack and remove jack and blocks.

POWER LEVELING JACKS

The power leveling jacks help turn on uneven sites into a pleasant camping area by allowing your camping vehicle to be adjusted. Your vehicle has jacks at all four corners and the front jacks have more capacity than the rear. When parking on a slope, face the vehicle downhill if possible. Block the wheels before proceeding.

CAUTION: Do not use the vehicle's leveling system for changing tires or for working under the vehicle without blocking the frame. Keep everyone away from the mechanism, especially when it is operating.

To Extend

1. Turn the ignition switch to **ACCESSORY** position.

2. Level the lowest corner first, then the next lowest corner. Leveling the vehicle may require only two or three of the jacks. When level, extend the remaining jack(s), just far enough to contact the ground to provide stability. On soft ground, place a wooden 2" x 6" pad beneath each jack for footing.

3. Turn off the ignition switch.

NOTE: The first movement of the control handle activates the pump; further movement opens the control valve to a jack. Do not hold the controls in this "pump only" position for too long. It will cause heat build up and draw too much current. Never extend all four jacks to their maximum position at the same time. This might raise the wheels from the ground and allow the vehicle to move dangerously to the front or rear.

To Retract

1. Slowly move one or more control levers forward. Hold there until the vehicle's entire weight is on the wheels again, then move the levers fully into the retract position.

2. Leave the controls in the retracted position while traveling.

BWB - AUTOMATIC LEVELING PROCEDURE

1. Place gear selector in neutral position and apply parking brake.
2. Stop the engine and turn ignition switch to accessory or ignition position.

NOTE: On the 37CBXS the engine must be off.

3. Turn on the leveling master switch. (If the master switch was "ON" turn "OFF" and then "ON". This resets the microprocessor to the start position.)

Red light on switch should now be on.

4. Press toggle switch toward "Automatic Leveling Position". All leveling units should swing from horizontal position to a vertical position. When this operation is in progress the red light on the automatic leveling switch will blink. Upon completion of this phase of the operation the red light on the "Automatic Leveling" switch will glow steady red, also the red lights on the four lower switches should now be lit indicating the jacks are in the vertical position. If the vehicle is parked on soft ground, blocks may be placed under the jacks for added support.

5. Again press toggle switch toward the automatic leveling position. The red light on the "Automatic Level" switch will start blinking and continue to blink until the coach is leveled and stabilised. Turn off Ignition Switch when the red light on the Automatic Level Switch stops blinking.

NOTE: For the 37CBXS the leveling system will dump the air suspension allowing 30 seconds for dumping, then level and stabilize the coach.

NOTE: If the vehicle is so far out of level that the leveling jacks can not level the vehicle even when fully extended a yellow light will be lit on one or two of the lower four switches.

WARNING: • Do not use the leveling system for changing tires or working under the vehicle without securely blocking the frame and wheels. If the rear wheel is lifted from the ground there is a possibility the vehicle may MOVE either toward the front or rear. • Keep all persons away from the leveling system mechanism when operating the leveling system, driving the vehicle and/or when the vehicle is parked. • Leveling units will ABRUPTLY SWING UP when the foot clears the ground.

Automatic Retract Procedure

1. Turn the ignition switch to the Accessory or Ignition position. *For the 37CBXS* start the coach engine and build up air pressure, until the air spring are inflated
2. Turn on-master switch. (If the master switch was "on" turn "off" and then "on". This resets the microprocessor to the start portion.) Red light on switch should now be on.
3. Press "Automatic Level and Automatic Retract" switch toward the "Automatic Retract" position. The red light on the retract side should now begin to blink. The jacks will now begin to retract. As soon as the foot clears the ground the jack will swing up to the horizontal position. When the jack reaches the horizontal position the red light on "Extend Retract" switch will go out. When all four lights are out it is safe to move the vehicle. After the jacks swing up they continue to retract, therefore it is important not to turn off the master switch until the red light on the "Automatic Retract" switch is out. The master switch will turn off automatically after 10 minutes or it may be turned off manually.

The red side of the four lower switches are connected to the warning system. The red side will glow when the jacks are in the vertical position and the ignition switch is in the "Ignition" or "Accessory" position. These lights are not affected by the master switch. Do not attempt to move the vehicle if any of the four red lights on these switches are on. It is safe to move the vehicle if these four lights are out even though the "Master Switch" and automatic retract red indicators are lit.

Maintenance

NOTE: It is important that the four leveling units are in the retracted position before checking the hydraulic oil level. To check the oil supply, remove the breather plug from the hydraulic oil reservoir. The oil level should be approximately (1) one inch below the top of the reservoir when adequately filled.

In general, to insure the smooth operation of the leveling system, it is a good idea to occasionally check the individual leveling units to prevent problems. This is especially true under conditions stated in the following:

Unusual Conditions

If driving conditions are unusually muddy the units may become caked or clogged with mud. This condition may hamper the proper operation of the leveling system. This problem may be prevented or remedied by cleaning off each leveling unit if they become excessively muddy.

In icy weather leveling units may become encrusted with ice. This may cause the leveling system to function improperly. To eliminate this problem, periodically check the leveling units, and break loose any ice which may be causing improper operation.

Do not move the vehicle while the leveling units are still in contact with the ground. However, if this should accidentally happen the leveling system is designed to protect itself from damage in most cases. Reset the "Master Switch" and follow the automatic retract procedure. Then visually check to see if the leveling units have returned to travel position.

NOTE: If the coach must be moved and the normal methods of retracting the jacks have failed proceed as follows: The drain valve is mounted in the access door to the rear of the right front wheel. The drain valve is a block with 3 T handles. Place a container under the drain valve. Slowly open each drain valve by turning each T handle approximately 3 turns. Drive the coach forward off the jacks. Stop and check that all jacks have returned to the horizontal (retracted) position.

CAUTION: Oil may squirt out of the drain valve when first opened and will squirt out when the coach is driven off the jacks.

See leveling system manual for additional information.

NOTES

A series of horizontal lines for writing notes, spanning the width of the page.

ELECTRICAL

Electrical System	34
General Information	34
AC/DC Panels	34
Battery	35
Battery Disconnect Switch	36
Invertor PAC-1500	37
Front and Rear A/C Switch	41
Ground Fault Interrupter	41

ELECTRICAL SYSTEM

Your vehicle is equipped with both 110V AC and 12V DC electrical systems.

110V Outside Power

Pull out the 110V AC grounded power cord and plug into the power source. Switch the main breaker to ON and the 110V system will energize all 110V circuits and receptacles. The power converter automatically supplies 12V DC power where needed inside.

12V Battery Power

When a 110V power source is not available, the camping vehicle batteries provide 12V current to the same points as the converter. The changeover is completed automatically.

Circuit breakers and fuses are installed to protect the circuits from overloading. Do not change the circuitry or add appliances yourself. See an authorized dealer.

Always use the vehicle's built-in power supply cord to connect with a 110V source. Note the grounded plug which provides the proper grounding for your protection from electrical shock. Do not use any adapter "cheater" or extension cord that breaks the continuity of the ground circuit. NEVER remove the ground pin to connect with a two prong, ungrounded receptacle.

NEVER operate the camping vehicle with a "hot skin". If you feel any shock, even a small one, disconnect from the 110V power and locate the fault. Usually it is a break in the grounding circuit. The grounding circuit must be continuous from the frame to the distribution panel, to the power cord, to-earth ground.

AC/DC PANELS

Trouble- Shooting

- Check the circuit breakers in the 110V AC distribution panel to be sure they are all on.
- Check the fuses in the 12V DC fuse panel to make sure they are all good.

If you have checked out the power panels and everything seems normal, then see your authorized dealer for assistance.

COACH BATTERY for CLASS A

The coach battery for a class A motorhome, supplied by Holiday Rambler Corporation is located just behind the front wheel on the roadside.

The auxiliary battery for a mini-motorhome is located on the roadside, behind the driver's door.

The auxiliary battery provides 12V current to the system when needed. It also operates the power step, electronic ignition water heater, refrigerator (in transit), and leveling jacks. In-line thermal breakers protecting these circuits are found near the battery.

The battery is recharged in transit by the vehicle's electrical system. When your vehicle is plugged into a 110V source, the power converter should automatically begin to recharge the battery, bringing it back to full charge.

When the vehicle is not in transit, the chassis battery is isolated from the camping vehicle battery. This prevents the chassis battery from being drained by interior 12 equipment and avoids a "can't start" situation.

The AUXILIARY START SWITCH on the instrument panel "borrows" power from the camping vehicle battery to start the engine, when the chassis battery can't. Ask your dealer to check the chassis battery and vehicle charging system if you use the auxiliary start often.

CAUTION: Do not store anything near battery that might touch the terminals. This could cause an electrical short circuit, drain battery power or even start a fire.

NOTE: If you won't be using your motorized unit for a long time, remove the battery and store it in a warm place. Mark the positive and negative cables for easy identification. Do not store the battery on a concrete floor. Charge the battery periodically during storage.

NOTE: Deep cycle RV/Marine batteries consume water which must be filled periodically. *Use distilled water only!*

BATTERY DISCONNECT

The Battery Disconnect provides a simple and safe means of disconnecting the coach and chassis batteries of your unit. With a touch of a switch on the monitor panel, located above the entrance door, the batteries will be completely disconnected. Advantages of using the battery disconnect switch include:

- Preventing unwanted discharging of batteries during extended periods of storage
- Preventing shorts or fire hazard while working on the 12-volt electrical system.

How & When to Use Battery Disconnect

Your Limited battery disconnect has dual "STORE/USE" switches. Dual switch units control the coach or "house" batteries and the chassis or "motor" batteries.

TO USE RV - Press the "STORE/USE" switch to the "USE" position momentarily. The indicator light(s) for the battery will glow indicating the presence of 12 Volt current on the system. Repeat this step for the second "STORE/USE" switch.

TO STORE RV - To prevent the discharge of your batteries press the "STORE/USE" switch to the "STORE" position momentarily. Repeat this step for the second "STORE/USE" switch if your unit is so equipped. If no external power (shore power or generator) is applied to the system the indicator light(s) should be extinguished.

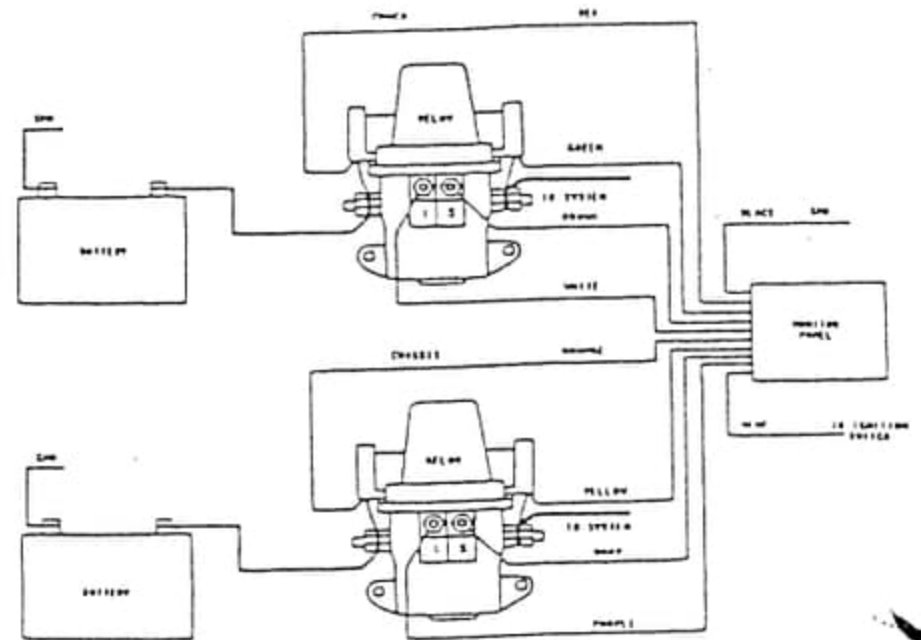

NOTE: If you are plugged into any 120 V A/C source the "IN USE" indicator light will remain lighted.

NOTE: When coach batteries are disconnected with the battery disconnect the security system, alarm clock, trip computer clock, and the dash stereo memory are still connected and draw approximately 30 Amps. For extended storage, disconnect the battery cables on the coach batteries.

INVERTOR - PACS-1500

PACS-1500 is a heavy duty, professional quality inverter, capable of providing up to 1500 watts of continuous power. Used for Imperial only.

The PACS-1500 Inverter is designed to operate the following:

- Microwave
- Television Sets
- VCR
- Stereo
- Kitchen Appliances that are plugged into kitchen receptacle.

You may use any combination of appliances, equipment or other items at one time, as long as the total of that operated at one time does not exceed PACS-1500 output capabilities.

Operating Information

To operate PACS-1500, simply push the "POWER" switch on, which will illuminate the "LOW BATT" and "OVERLOAD" LEDS, as well as the power switch. This is normal. Press the "RESET" button which will turn off the LEDS. Set the selector switch to either microwave and kitchen receptacle or TV's, VCR, blender and rear stereo. The unit is now in a stand-by "auto-on" mode, as the inverter will turn on or off in response to load demand.

PACS-1500 requires approximately 3 Amps of battery power when left in an "auto-on" mode when there is no external load. The unit automatically senses the request to supply power, and turns on and shuts itself down automatically based on external load requirements. This energy saving feature will greatly extend the charge level of your battery since many appliances require intermittent power.

Operating Time - Use the following chart as a guideline for PACS running times. Many items operated from PACS are not running continuously, but only used intermittently, i.e. microwave, TV, VCR, etc. The hours have been factored for PACS efficiency using a fully charged battery (13 volts) to PACS low battery shutdown (10 volts). The chart is only applicable when batteries are not being recharged, i.e. alternator is not operating.

<u>Load Operating from PACS</u>	<u>Battery Current Required</u>
100 Watts 21 Hrs.	
200 Watts	21 Amps
250 Watts 10-1/2Hrs	
500 Watts 5 Hrs	47 Amps
1000 Watts 2-1/2 Hrs	90 Amps
1500 Watts 1-1/2 Hrs.	140 Amps

Your operating time is dependent on the following conditions:

1. Load Wattage - Larger items will require more battery power than smaller items and will therefore discharge the batteries more quickly.

APPROXIMATE WATTAGE RATING ON PRODUCTS TYPICALLY OPERATED FROM PACS:

<u>PRODUCT</u>	<u>WATTAGE RANGE</u>
Microwave	1200
Fry Pan	1000-1300
Toaster	1100-1400
Coffee Pot	500-1000
Hair Dryer	500-1000
Vacuum Cleaner	400-800
VCR	75-200
Color TV	60-150
Stereo	40
Power Drill, Consumer	500-800
Mini Computer/Printer	200-1000

Battery Age - Older batteries do not store charge levels as long as newer batteries.

Alternator/Generator Charging Batteries - When the PACS batteries are being recharged while operating your PACS, the batteries will not be discharged if the alternator charge rate is sufficient. If the alternator charge rate is adequate, you may operate the PACS indefinitely.

Maintenance

PACS-1500, with proper care, will provide excellent performance for many years. Since PACS utilizes solid state electronic "state of the art" design, no maintenance is required. The only maintenance required is to your batteries.

Batteries - We recommend you disconnect the battery cables from the battery post if seasonal storage of your vehicle is anticipated for 60 or more days.

Turn "OFF" the battery disconnect for storage of less than 60 days.

It is not necessary to disconnect the batteries only turn PACS-1500 "OFF" for short periods of non-use, as PACS-1500's Auto-On feature consumes approximately 3 Amps of battery power when items are not being operated from PACS-1500

CAUTION: Protect PACS-1500 from dust and moisture during storage, as this could damage PACS-1500 parts.

Troubleshooting

The below chart is a guide to aid you on minor malfunctions. If the problem has not been corrected after following the guide, DO NOT attempt repairs.

CAUTION: To prevent electrical shock, DO NOT REMOVE COVER. No user serviceable parts inside. Refer servicing to qualified personnel or to GTO Electronics.

TROUBLE: PACS-1500 will not operate equipment.

1. No 12V Battery Voltage - batteries are not properly connected or discharged.
2. Reverse Polarity - Battery line fuse will blow if terminals have been attached backwards.
3. Remote Panel Short - 1 amp fuse will blow if panel or harness has a short.
4. Fuse Replacement - Measure continuity on both battery line fuse and remote fuse. Remote Fuse - 3AG1A Slo Blo. (GTO P/N 145-011) Battery Line Fuse - Bussman FWA 175 (GTO P/N 145-013)
5. Remote Panel Connected - Assure connectors on panel and PACS "snap" into place.
6. 15 AMP Circuit Breaker - Assure circuit breaker in PACS front panel is in the "ON" position.
7. Bonding Lug - This lug must be connected to the chassis ground with a #6 AWG wire.
8. Insufficient Load - Auto-On circuit requires a minimum load of about 15 watts.
9. Thermal Protection - Let unit cool down if it has been heavily loaded.

TROUBLE- PACS will not start equipment and "OVER-LOAD" illuminates.

1. Excessive Load - Load may be rated in excess of PACS-2500 capabilities. Check wattage or current rating of equipment to assure it does not exceed the output rating.
2. Equipment has a short.

TROUBLE-"LOW BATT" LED illuminates

1. Batteries Discharge - Check battery charge level to assure sufficient current.
2. Loose connections - Battery connections must be secure to eliminate a possible voltage drop.

TROUBLE- PACS shuts off and cannot be restarted. Neither LED illuminates or power light.

1. Thermal Protection - Let unit cool down if it is warm or if it has been heavily loaded.
2. Battery Power Interrupted - Check battery line fuse and/or remote fuse.

TROUBLE-PACS will not shutoff when no load is apparent.

1. Hidden Load - Many items, such as TVs, VCRs, etc., draw power and will keep PACS operating.

TROUBLE-PACS will not start a TV when in the stand-by mode.

1. Nearly all AC/DC TV's and some AC only TV's will not start on any auto-on inverter or generator. To operate TV, simply turn on PACS by operating another item first, then turn on your TV, after which you may turn off all other items.

TROUBLE-Battery Line fuse blows.

1. Reverse Polarity-Protects PACS, if battery connections are reversed.
2. Shorted Cable - A short in the cable beyond the fuse leading to the PACS-1500.
3. Overload - Backup protection of an overload if LED overload circuitry fails.

TROUBLE-AC voltmeter does not indicate 120VAC.

1. This is due to the quasi-sine wave. Use a true RMS voltmeter to achieve accurate readings.

TROUBLE-15 Amp circuit breaker trips "OFF"

1. Transfer Switch Fault - Protects from possible malfunction in transfer switch. Check wiring to assure proper switching.
2. "Gradual" Overload - You may experience certain items which draw more current as they continue to operate.

TROUBLE-Battery Cables are hot or burned.

1. Connections - Assure cable connections are clean and very secure. Use quality connecting lugs.

TROUBLE-Microwave oven requires longer cooking time.

1. This is due to the invertors lower peak voltage. The battery input voltage must remain between 12.5-14.5VDC for proper cooking times. The lower the battery voltage, the longer your cooking times will be.

TROUBLE-Digital LED clock gains time when only the clock is operated from PACS.

1. This is due to the extremely low wattage required by the clock itself. These clocks will operate correctly by operating another nominal load with the PACS-1500.

GROUND FAULT CIRCUIT INTERRUPTER (GFCI)

When properly installed, the GFCI receptacle and every standard receptacle downstream on the same branch circuit provides overload and short circuit protection, plus protection from ground faults between a "hot" wire and ground.

IMPORTANT: The GFCI will NOT reduce shock hazard if the short is between a "hot" and a neutral wire or two "hot" load wires.

Testing Instructions

- At the circuit breaker, turn the power ON to the circuit.
- Depress the "TEST" button, the RESET button should now be extended.
- To reset, depress the "RESET" button firmly into the GFCI unit until an audible click is heard. If the reset is done properly, the "RESET" button will be flush with the surface of the "TEST" button.

IMPORTANT: If the "RESET" button does not extend, the GFCI will NOT protect against electrical shock. Notify your dealer immediately.

Test the GFCI monthly and record the results on the chart supplied in your Owner's Packet.

WARNING: The GFCI protects ONLY the circuit to which it is connected. It does not protect any other circuit.

AIR CONDITIONER SWITCH

(Units with 2 Roof Air Conditioners Only)

The air conditioner selector switch is located next to the AC circuit breaker panel. Use the selector switch to select which air conditioner operates from shore power. RE: When set to front A/C the front roof A/C operates on shore power. Anytime the generator is running both air conditioners may be operated regardless of switch selection.

NOTES

A series of horizontal lines for writing notes, with three punch holes on the right side.

APPLIANCES

Refrigerators RM3801 & 3601	54
Refrigerators RM2803, 2603	55
Food Storage	55
Defrosting	56
Ice Making	56
Shut-off the Refrigerator	56
Gas Burner	56
Ice-maker	57
Range	58
Range Top	60
Range Care and Cleaning	60
Range Warning	61
Range Hood	61
Furnace	
Operation	62
Preventative Maintenance	62
Maintenance	62
Seasonal Cleaning	63
Water Heater	
Electronic Ignition	64
Food Center Blender	66
Washer	67
Dryer	70

L.P. GAS

We recommend that you have the LP gas system checked by your authorized dealer at least once a year, and after every extended trip. Although the manufacturer and dealer test carefully for leakage, travel vibrations could loosen fittings and cause leaks. Leaks can be found easily by applying soapy water at the connections. Tightening the fitting usually stops leaks. If not, shut off main gas valve at tank and see your authorized dealer for repairs immediately.

Because LP gas is heavier than air, leaking gas tends to collect in low areas. The identifying odor is onion or garlic. **NEVER LIGHT A MATCH OR ALLOW AN OPEN FLAME WHERE YOU SUSPECT LEAKING GAS.**

SHUT OFF THE MAIN GAS VALVE AT THE TANKS WHEN THE CAMPING VEHICLE IS NOT IN USE. ALSO, SHUT THE VALVE WHEN REFUELING THE TOW VEHICLE TO AVOID POTENTIAL DANGER FROM PILOT LIGHTS IGNITING FUEL FUMES.

WARNING: Do not bring or store LP Gas containers, gasoline, or other flammable liquids inside the vehicle. If this warning is ignored, a fire or an explosion could result.

LP Gas containers are equipped with safety devices which relieve pressure by discharging gas into the atmosphere. LP Gas regulators are installed with the diaphragm vent facing downward. Regulators that are not in compartments have been equipped with a protective cover.

NOTE: Make sure that the protective cover is kept in place to minimize vent blockage that could result in a build-up of gas pressure causing fire or explosion.

Filling the LP Gas Tank

Woodall's *Campground and Trailer Guide* and other publications list refueling stations. Many travel parks also sell LP Gas.

Caution the supplier not to overfill your tank. A relief valve is built into most tanks, and needs to be opened during refilling. The tank is full when the valve allows a small amount of liquid to escape. At all other times, the valve should be tightly closed by hand.

NOTE: Over-tightening the valve could ruin the seal on the valve

When the tank is filled to the proper level there is space available for expansion of the liquid into gas. If a tank is overfilled, it may vent pressure from the relief valve. When this happens you can detect a strong garlic odor near the tank and you may be able to hear a hissing noise.

WARNING: Keep open flame and spark producing materials away from the lp area. It is best to move the vehicle to a safe place and bleed off excess pressure by opening the relief valve. Be sure to turn off all appliances while venting the LP gas.

Turn off the main valve on the LP tank while traveling or when the camping vehicle is between trips. Hand tighten the valve. Over-tightening may permanently damage the valve seat.

General Information

Like the other systems in your camping vehicle, components for the LP Gas system are approved for use in camping vehicles by a nationally recognized testing laboratory. When properly handled, LP Gas is a clean burning, dependable fuel for your heat producing appliances.

The LP Gas tank mounted on your camping vehicle contains liquid under high pressure. As fuel is used, the liquid vaporizes into gas and passes through the tank valve to a regulator which automatically reduces the pressure. The low-pressure gas is then distributed to the appliances.

The most common cause of appliance lighting problems is an improperly adjusted gas regulator. Never attempt to reset the regulator yourself. Even a little excessive pressure can result in damage to the appliance regulators. Have your dealer or an authorized service person make the adjustments required for high altitudes or temperature extremes.

LP Gas Consumption

Each gallon of LP Gas produces about 91,000 BTU's of heat. Total consumption depends on the usage rate for each appliance and its operating time. The oven and the heating system use the most gas. With sub-freezing temperatures and high winds, furnace consumption can be very high. Check tank levels often in cold weather.

Gas Distribution Lines

The primary manifold is a black steel pipe running the length of your R.V. All secondary lines leading to gas appliances are copper tubing with flare fittings. If any of these lines rupture, do not attempt to splice it. Always run a new line. We recommend any gas distribution work be performed by a dealer or authorized service person.

When removing or servicing any gas appliance, close the main valve at the LP tank. This will prevent dangerous gas leakage which could result in an explosion causing serious injury.

If you suspect a leak, get the system inspected and repaired by a qualified service technician as soon as possible.

Precautions and Recommendations

- Visually inspect LP fill valve for contaminants before refueling.
- Never use an open flame while checking for gas leaks.
- Shut off pilot lights while refueling.
- Visually inspect gas line hangers periodically.

Have your LP Gas system checked annually by your dealer and before and after long trips.

- Only a qualified technician should make repairs to the gas system and appliances.

THE FOLLOWING LABEL HAS BEEN LOCATED NEAR THE LP GAS CONTAINER:

THIS GAS PIPING SYSTEM IS DESIGNED FOR USE OF LIQUEFIED PETROLEUM GAS ONLY. DO NOT CONNECT NATURAL GAS TO THIS SYSTEM. DO NOT FILL CONTAINER(S) TO MORE THAN 80 PERCENT OF CAPACITY. Securely cap Inlet(s) when not connected for use. After turning on gas, except after normal container replacement, test gas piping and connections to appliances for leakage with soapy water or bubble solution. Do not use products that contain ammonia or chlorine.

WARNING

ALL PILOT LIGHTS & APPLIANCES SHALL BE TURNED OFF DURING REFUELING OF MOTOR FUEL TANKS AND/OR LP GAS CONTAINERS

NOTE: The above label is not shown actual size.

LP GAS LEAK DETECTOR - Optional

Read instructions on the label near leak detector. Then check fluid level through the glass sight port. If below mark, push plunger rapidly several times to return fluid to sight glass.



Rosan® Leak
Detector

To test your leak detector:

1. Close main LP Gas valve.
2. Ventilate interior by opening windows and doors.
3. Shut off all LP Gas appliances and pilot lights.
4. Light one burner to exhaust pressure in the system. This will take a couple of minutes. Close valve when flame goes out. If flame continues to burn, close main valve more tightly.
5. While depressing the red button on the leak detector, open the main valve on the LP Gas tank. You will see a stream of bubbles, which should disappear in about two seconds. Continue to hold down the red button for another five to ten seconds.

6. If the bubbles are still visible during this test period, your LP Gas system has a leak. (Open the main LP Gas valve to re-pressurize the system). Test all joints with soapy water, then tighten if necessary.

7. Re-conduct the test (steps 1 through 6). If the leak detector still bubbles, see your dealer.

The Model 116M is a U.L. listed, in-line, bubble type, L.P. Gas Leak Detector. It is designed to quickly detect leakage in any L.P. Gas (Vapor Phase) piping and appliance system.

The test should be done as often as you the owner thinks necessary. We suggest that this test be done before each trip, after arrival and when you return.

LIQUID PROPANE GAS SENSOR

Introduction

The Ten-Tek model 800T Gas Sensor is a technologically advanced device specifically engineered for use in recreational vehicles. The unit is designed to detect propane gas at a concentration in excess of 25% of the Lower Explosive Limit.

Please read the following bulletin carefully to ensure that you and your family receive maximum benefit from the Ten-Tek model 800T gas detector.

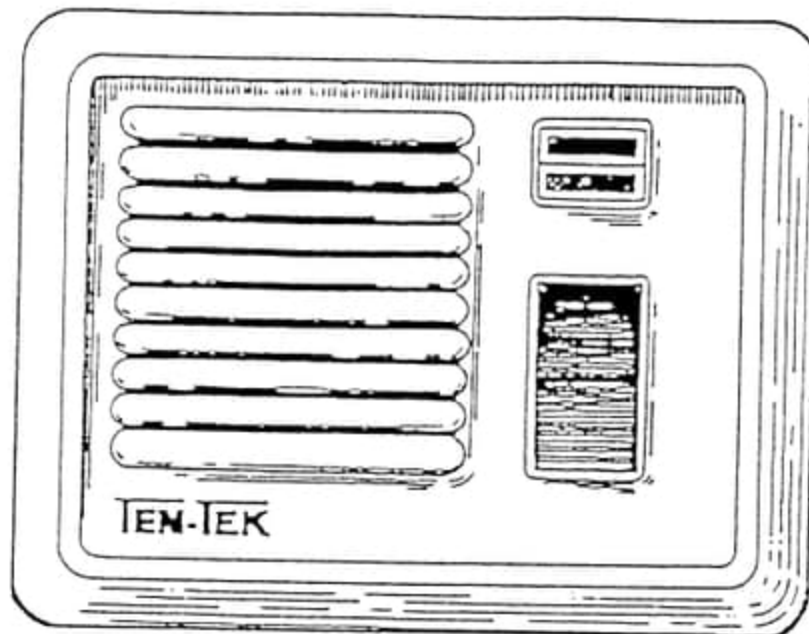

Specifications

Operating Voltage	12 Volts DC
Acceptable Voltage Range	10.5V to 18.0 V DC (FWR)
Standby current	NOMINAL 12 VDS detector 200 MA AVG.
Gas Detection Level	25% of the Lower Explosive Limit of Propane Gas
Audible Alarm Level	85DB at 10 feet
Warm-up Period	2.5 minutes(Approximate)

What You Should Know About Your LP Gas Sensor

The Ten-Tek model 800T is designed to detect liquid propane gas at a concentration in excess of 25% of the Lower Explosive Limit (LEL). The Lower Explosive Limit (LEL) is the level of gas in the air at which the gas-air mixture becomes explosive. Propane has an LEL of 2.1%. If the 2.1% level is reached the air-gas mixture is explosive. The Ten-Tek 800T is designed to detect levels of propane in excess of 0.52%. If the concentration of gas is less than these levels the gas may be unable to trigger an alarm. The Ten-Tek 800T is designed to detect the propane leaks before the gas concentrations at the detector reach explosive levels.

NOTE: Liquid propane gas is heavier than air and will settle to the lowest point. Your gas detector is installed near the floor of your vehicle.

How to Operate

When Propane Supply is Required:

1. Turn the gas detector ON by moving the ON/OFF/TEST switch to the ON position. The green 'POWER' LED should come on immediately. Wait for 2.5 minutes (approximately) to allow the sensor to warm up before testing the gas detector or using the gas detector or using your gas appliances.

2. Open the main gas valve.

(more instructions on the next page)

3. LIGHT ALL PILOT LIGHTS according to the manufacturer's instructions.
4. Use gas as required.

NOTE: If the unit gives a brief "beep" every 30-60 seconds refer to the "TROUBLE-SHOOTING" GUIDE BELOW.

WARNING: The gas alarm will draw an average current of 0.2 amperes during normal operation. To avoid battery drain when propane is not required, CLOSE THE MAIN GAS VALVE ON THE PROPANE TANK, and place the ON/OFF/TEST switch in the OFF position to turn off the gas detector. The "POWER" LED should go out immediately.

How to Reset

1. Turn the ON/OFF/TEST switch to the OFF position; then
2. Turn the ON/OFF/TEST switch to the ON position and wait 2.5 minutes (approximately).

Alarm

If the gas detector senses gas concentrations in excess of its calibrated operating threshold:

1. An audible pulsating alarm should sound, and
2. The red "ALARM" LED should light.

What to Do When an Alarm Sounds

If your gas alarm sounds and the red "ALARM" LED is on:

1. Extinguish all open flames, pilot lights, and smoking materials, etc.
2. DO NOT touch the electrical switches.
3. Shut off the gas supply at the propane tank (main gas valve).
4. Open doors and windows for ventilation.
5. Leave your Recreational Vehicle until the audible alarm stops and all odor clears.
6. Have your gas system checked and the leakage source corrected before using your gas supply again.

NOTE: Pilot lights may burn for several minutes after the tank valve has been closed as they will be depleting gas still present in the gas supply lines.

The pulsating alarm is designed to stop sounding when the gas concentration at the detector goes below the calibrated level. The "ALARM" LED is designed to remain lit until the gas system is manually reset. Do not reset your gas detector until you have corrected the gas leak situation or a qualified gas dealer or RV service center has made necessary repairs at the source of the leak.

To reset, follow instructions "HOW TO OPERATE" section of this manual.

Testing - Test Switch

The gas detector is proved with a TEST switch which, when activated, is designed to provide a rapid check of the circuitry is functioning.

Turn the gas detector on as described in "HOW TO RESET". The green "POWER" LED and the unit silent. Wait for approximately 2.5 minutes.

Press and hold the TEST switch in the TEST position for 5 seconds. The audible alarm should cycle on and off and the red "ALARM" LED should light.

Release the TEST switch to return the switch to the ON position. The pulsating alarm should stop. The red "ALARM" LED should remain lit to indicate that the unit had gone into alarm.

Turn the TEST switch to the OFF position and reset as described in the "HOW TO RESET" paragraph of this manual. *Repeat this test weekly.*

The test switch provides an internal electrical sensitivity check only. It does NOT indicate such problems as back-drafts, or a plugged sensor. It is highly recommended that an additional test be performed using a butane lighter.

Turn the gas detector OFF and reset as described in "HOW TO OPERATE" section of this manual.

Should the detector fail to perform as described during either of the above test procedures, turn off the gas detector, turn off the main gas valve and consult a qualified RV service representative for repair or replacement. Do not use your propane gas supply until your detector has been repaired.

Maintenance

The gas detector is factory calibrated and sealed for your protection. Because the detector is located near the floor, care must be taken to avoid damage from kicking.

DO NOT BLOCK THE DETECTOR IN ANY WAY BY STORING LUGGAGE OR OTHER ITEMS IN FRONT OR BACK OF IT.

Testing should be performed as described in "TESTING" section of this manual to determine that the detector responds to gas, the solenoid valve operates as intended and interconnect wiring is intact.

Should the detector fail to perform during testing consult a qualified RV representative for repair or replacement. Do not use your propane gas supply until all necessary repairs have been made.

Every month vacuum the detector with a soft brush attachment in the area of the gas sensor to remove any loose lint that may accumulate.

Trouble-shooting

Trouble Signal:

An audible trouble "beep" once every 30 to 60 seconds may indicate one or more of the following problems:

1. Battery voltage is lower than that required to operate the unit properly.
2. Gas sensing device has failed.

If the cause of trouble indication is (1) above, recharging the battery and then resetting the alarm as described in "HOW TO OPERATE" should restore the detector to operation. If (2) is the cause, resetting will not restore operation. In this instance, turn OFF the gas detector, turn OFF the main gas valve at the propane tank and see a qualified service representative for repair. Do not use your propane gas until your detector has been repaired.

"ALARM" LED Turns On During Operation

If the red "ALARM" LED is on during operation, but the audible alarm and/or trouble signal are not sounding the cause may be:

1. The unit went into alarm earlier, but the level of gas concentration has since dropped below the calibrated operating threshold, causing the alarm to stop sounding.
2. The audible alarm signal is not operational.

ALWAYS TREAT THIS AS AN ALARM SITUATION and follow the instructions in the ALARM section of this manual. Once a gas leak or other problem has been located and repaired, reset the detector.

"POWER" LED Off

If the green "POWER" LED is off during operation or after resetting, the cause may be:

1. The detector is not receiving power.
2. The "POWER" LED has failed.

Turn the detector off. Restore power to the detector and reset as described in the "HOW TO RESET" section. If the green "POWER" LED does not light immediately after resetting, check the fuse for the detector and replace if necessary and reset.

If the green "POWER" LED still does not turn on, turn off the main gas valve at the propane tank, turn off the gas detector and call a qualified RV service representative for repair or replacement. Do not use your propane supply until all necessary repairs have been made.

False Alarms

Your LP gas detector is also sensitive to fumes such as those from alcohol, hairspray, perfume, liquor, deodorants, some cleaning agents, etc. As most fumes from these chemicals are lighter than air, they will not be detected by the gas detector, unless sprayed or exposed directly into the sensor.

It, however, a strong cleaning agent or any of the above compounds are to be used on or near the floor, turn off your gas detector and turn off the gas at the main tank. Air out the vehicle and reset the detector.

Limitations of Gas Detectors

Quality gas detectors are designed to give the earliest possible warning of gas leaks at reasonable cost. Early warning may mean the difference between a safe escape and no escape at all. While gas detectors may provide valuable protection for you and your family, it must be recognized that detectors have limitations.

Gas detectors cannot work without power. A gas detector will not work on low or dead battery, or if its power is cut off by an electrical fire, an open fuse, a tripped circuit breaker, or any other reason.

Gas detectors are incapable of triggering an alarm until gas reaches the sensing chamber. Anything preventing gas from reaching the device may delay or prevent an alarm. Turbulent air currents from air currents from fans, open doors, open windows, etc. may prevent gas from entering the detector. Avoid such conditions. If in doubt as to the best location, consult your local gas authority. A gas detector cannot detect gas in the walls, ground or roof unless and until a significant quantity of gas reaches the detector. A closed door may prevent gas from reaching a detector on the other side of the door. For These reasons a gas detector should be located near every gas appliance.

Gas detectors have other obvious limitations. For example, gas detectors are calibrated for specific gasses. The Ten-Tek 800T is designed to detect propane only. It should not be relied upon to detect any other gasses.

APPLIANCES

Refrigerators RM3801 & 3601	54
Refrigerators RM2803, 2603	55
Food Storage	55
Defrosting	56
Ice Making	56
Shut-off the Refrigerator	56
Gas Burner	56
Ice-maker	57
Range	58
Range Top	60
Range Care and Cleaning	60
Range Warning	61
Range Hood	61
Furnace	
Operation	62
Preventative Maintenance	62
Maintenance	62
Seasonal Cleaning	63
Water Heater	
Electronic Ignition	64
Food Center Blender	66
Washer	67
Dryer	70

DOMETIC REFRIGERATORS

Leveling

In the boiler, ammonia vapor is distilled from an ammonia-water mixture and carried to the finned condenser, where it liquifies. The liquid flows to the evaporator, where it creates cold by evaporating into a circulating flow of hydrogen gas. If the evaporator or coil is not level, the liquid readily accumulates, forming pockets which can impair the gas circulation or even block it in which case, of course, the cooling will stop.

When the recreational vehicle is stationary, it must be leveled to live in comfortably. If the refrigerator is properly leveled, i.e. the freezer shelf parallel to the floor, the refrigerator then will also perform well. To check this, a bubble level is supplied with every Dometic Refrigerator. The level should be placed on the freezer shelf. Bubble position is most conveniently checked with a small mirror. When the vehicle is in motion, the continuous rolling and pitching movement will not affect the refrigerator as long as the movement passes either side of the level. When the motorized vehicle is temporarily parked, however, make sure the refrigerator is level.

FOR MORE INFORMATION ON THE OPERATION OF THE REFRIGERATORS, PLEASE REFER TO THE OPERATING INSTRUCTIONS FROM THE MANUFACTURER IN YOURS OWNER'S PACKET.

RM3801 AND RM3601

This refrigerator is equipped with an Automatic Energy Selector (AES) System. The control system selects the most suitable energy source. The selection will be made with highest priority to 120V, second priority to 12V from the alternator. Lowest priority as gas operation. No manual operation is necessary for change of energy source unless desired. The automatic energy control will, when switched on, start up in AES mode. The AES mode follows the above mentioned priority list and will select the best energy source available.

Before starting the refrigerator, check the gas valve in the piping. Do not forget the valve on the rear of the refrigerator.



1. To start the refrigerator set the switch (1) to position ON. Lamp AES shall now be green.
2. Turn the thermostat knob inside the cabinet to suitable setting, e.g. start with normal position.
3. To shut off the refrigerator, set the switch (A) to position OFF.

RM2603 & RM2803

Before starting the refrigerator, check the gas valve in the piping. Do not forget the valve on the rear of the refrigerator.



2

1. To start the refrigerator, set the switch(2) to the ON position. Lamp (4) shall now be green.
- 2 Turn the thermostat knob inside the cabinet to a suitable setting, e.g. start with a normal position.
3. To shut off the refrigerator, set the switch (2) to the OFF position.

General

This refrigerator is equipped with an Automatic Energy Selector (AES) system. The control system selects the most suitable energy source. The selection will be made with 120 Volt power chosen first (if it is available), followed by gas operation. No manual operation is necessary for change of energy source unless desired. The automatic energy control will, when enabled, start up in the AES mode.

Food Storage Compartment

The food storage compartment is completely enclosed and unventilated, which is necessary to maintain the required low temperature for food storage. Consequently, foods having a strong odor or liable to absorb odors should be covered. Vegetables, salads, etc. should be covered to retain their crispness. The coldest positions in the refrigerator are underneath the cooling evaporator and at the bottom of the refrigerator, and the least cold positions are on the upper door shelves. This should be considered when different types of food are placed in the refrigerator.

Frozen Food Storage Compartment

The ice trays should be placed in direct contact with the freezer shelf for fastest ice making. Quick frozen soft fruits and ice cream should be placed in the coldest pan of the compartment which is at the bottom of the aluminum liner or, in models with a shelf, on this or just below it. Frozen vegetables, on the other hand, may be stored in any part of the compartment.

The compartment is not designed for the deep or quick freezing of foodstuffs. However, meat or fish foods, whether raw or prepared and provided they are pre-cooled in the refrigerator, can also be stored in the frozen food storage compartment. They can then be stored about three times as long as in fresh food storage compartment.

CAUTION: Do not store explosive substances in the refrigerator, such as cigarette lighter gas, petrol, ether or the like.

Defrosting

- Shut off the refrigerator.
- Empty the refrigerator, leaving the drip tray under the finned evaporator and the cabinet and freezer doors open. If desired, defrosting may be speeded up by filling the ice tray with hot water and placing it in the freezer. It might be necessary to empty the drip tray one or two times during the defrosting period. When all frost is melted, empty the drip tray and dry the interior of the refrigerator with a clean cloth.
- Replace the drip tray and ice tray, replace all food and set the thermostat to **MAX** for a few hours. Then reset the thermostat knob to its normal position.

Ice-making

Ice cubes can be made in the ice trays which should be filled with water to within 1/4" (5mm) from the top. To release the ice cubes, seize the tray with both hands and twist the tray. Cubes not required should be placed in a storage container. Refill the tray with water and replace tray on the freezer shelf. Ice-making is accelerated if the thermostat knob is turned to the **MAX** setting. It is a good idea to do this a few hours before anticipated need for ice, but be sure to turn knob back to normal setting when the ice is formed or the foodstuffs in the cabinet may be come frozen hard.

To Shut Off the Refrigerator

To shut off the refrigerator, move the switch/knob to off position. If the cabinet is not in operation over a period of weeks, it should be emptied and cleaned and the door left ajar. Some models come with interior lights. To avoid discharging the battery, use tape to close the switch or remove the lamp. The ice trays should also be dried and kept outside the cabinet.

Gas Burner Inspection and Maintenance

Your refrigerator gas burner is subject to dirt, corrosion and rusting, any of which can impair the operation of the unit. Also, LP Gas has a natural "drawing effect" on spiders, which will build webs in the gas burner. We recommend that you have the burner inspected and maintained either by your Holiday Rambler dealer or a Dometic Service Center.

ICEMAKER

Operating Instructions

1. When unit is new, or out-of-service for some time, throw away the first two or three batch of ice cubes.
2. If ice cubes stick together, separate by hand or with a blunt tool. **NEVER USE AN ICE-PICK, KNIFE OR ANY SHARP OBJECT WHICH COULD PUNCTURE OR DAMAGE THE PLASTIC INTERIOR.**
3. Empty every week or ten days to insure a fresh cube supply.
4. Do not use solvents, abrasives or oily cleaners that might give ice an unpleasant taste. Clean condenser every three months. To remove grille, lift up and out.
5. Do not use electric heat to defrost; it would damage the inner liner.
6. To shut down, turn off switch behind grille. Prop open door to allow air circulation and prevent mildew.

RANGE

Operating Instructions

This range is equipped with a top burner and an oven standby pilot.

CAUTION: Before operating the range, always light both the top pilot and oven standby pilot. Both pilots receive gas through the oven thermostat control. If only one pilot is lit, gas will escape from the pilot which is not lit.

Light Top Pilot and Oven Standby Pilot:

1. Press in the oven thermostat knob and turn to OFF position.
2. Wait 4-10 seconds for air to clear from gas line.
3. Place a burning match over top pilot and oven standby pilot until the pilots ignite.

NOTE: Pilots will remain on until oven thermostat is pressed and turned to the PILOT OFF position.

To Light Top Burner:

CAUTION: Be sure pilots are burning. If not, follow lighting instructions for lighting pilots.

Press in burner knob and turn knob counter-clockwise until burner ignites. Continue to turn until desired flame is established.

To Light Oven Burner:

CAUTION: Be sure oven standby pilot is burning. If not, follow lighting instructions for lighting pilots.

1. Turn thermostat knob to desired temperature. There should be approximately a 30-second delay before oven burner ignites.
2. The oven standby pilot increases to a larger flame and begins heating the heat sensing bulb of the oven safety valve.
3. When the heat sensing bulb is heated, the oven safety valve opens and lets gas into the main burner.
4. The pilot ignites the oven burner.
5. Burner heats oven to temperature setting of thermostat.

6. Thermostat stops calling for heat.
7. Pilot flame subsides.
8. Burner remains on until heat sensing bulb on oven safety valve cools.
9. Oven safety valve closes and burner goes off.
10. Oven is ready for another cycle.

NOTE: Please see manufacturer's operating instructions contained in the Owner's Packet.

Care And Cleaning:

1. For ease of cleaning, the oven has a Vestar finish. The oven should be cleaned regularly using hot water, mild detergent and a soft cloth. Do not use commercial oven cleaners, cleaners with abrasive compounds or abrasive pads. If the finish is accidentally removed, it will not impair operation of the oven.
2. To clean the area under the top burners, either raise or remove the main top.
3. If the top burner heads are cleaned with any cleaning compound, care should be taken to see that all ports are opened up with a toothpick to insure proper operation. It is especially important that the lighter ports on the side of the burner head are kept clear.

WARNING: Portable fuel burning equipment including wood and charcoal grills and stoves, shall not be used inside the recreational vehicle. The use of this equipment inside the vehicle may cause fire or asphyxiation.

CAUTION: Before operating the range always make sure the oven pilot is lit.

RANGE TOP

WARNING: The range burners are NOT to be used for comfort heating. The combustion of the fuel can produce carbon monoxide which has dangerous effects on people and can cause death.

To Light Top Burners

CAUTION: Be sure the pilots are burning. If they are not, follow the instructions in the Owner's Packet for lighting pilots.

1. Press in the burner knob and turn the knob counter-clockwise until the burner ignites.
2. Continue to turn until the desired flame is established.

NOTE: Please see the manufacturer's operating instructions contained in the Owner's Packet.

Care and Cleaning

1. To clean the area under the top burners, release the latch in front of the main top; the main top can either be raised or completely removed.
2. If the top burner heads are cleaned with any cleaning compounds, make sure that all ports are opened up with a toothpick to insure proper operation. It is especially important that the lighter ports on the side of the burner head are kept clear.

Cooking appliances need fresh air and good ventilation for safe operation.

Before Operating:

1. Open the overhead vent (s) or turn on the exhaust fan, and
2. Open a window.

A warning label has been located in the cooking area to remind you to provide an adequate supply of fresh air for combustion. Unlike your home, the oxygen supply is limited due to the size of the recreational vehicle, and proper ventilation when using the cooking appliance(s) will avoid the dangers of asphyxiation. It is especially important that cooking appliances not be used for comfort heating since the danger of asphyxiation is more severe when the appliance is used for prolonged periods of time.

A label has been placed near the range area that reads as follows:

IF YOU SMELL GAS

1. Extinguish any open flames, pilot lights and all smoking materials.
2. Do not touch electrical switches.
3. Shut off the gas supply at the tank valve(s) or gas supply connection.
4. Open doors and ventilating openings.
5. Leave the area until the odor clears.
6. Have the gas system checked and the leakage source corrected before using again.

WARNING: Portable fuel-burning equipment including wood and charcoal grills and stoves, should not be used inside the R.V. The use of this equipment inside the vehicle may cause fire or asphyxiation.

RANGE HOOD

Release damper lock and the *exterior vent lock* before using. See the decal on the hood. Clean range hood after each use and protect the surface with a light coating of baby oil.

FURNACE

Operating Instructions

WARNING: Never attempt to modify this furnace!. Fire, explosion, asphyxiation or carbon monoxide poisoning may result. If a malfunction occurs call your serviceman.

1. To light the furnace, turn the thermostat to the lowest setting or "OFF" and wait 5 minutes.
2. Set thermostat to desired temperature setting.
NOTE: Some thermostats have a manual "OFF" . Switch to "ON" position.
3. Allow 15 to 30 seconds for blower operation and for the burner to light.
4. If burner does not light set the thermostat to "OFF" or lower setting and repeat steps 1 through 3.
5. If after 3 tries you have no ignition - shut down.

To Shut Down

1. Turn thermostat to the "OFF" position.

Preventive Maintenance

1. Clean complete furnace and air tube passageways periodically as needed to remove dust, lint, etc.
2. Check gas system for leaks at least once a year.
3. Check and clean blower wheel annually.

WARNING: If coach is equipped with a dual AC/DC electrical system or a generator, make sure thermostat is turned to the "OFF" position before switching from one power source to another.

Maintenance

FOR YOUR SAFETY: Do not use gasoline or other flammable vapors and liquids in the vicinity of this or any other appliance

CAUTION: Care should be taken when washing your vehicle so water is not aimed directly into the furnace vent. If water is forced past the rain baffles in the furnace vent, rusting of the furnace and improper combustion could occur.

The control compartment of the furnace must be kept clean. Failure to do so could result in operational or fire hazards.

Electrical power to the furnace should be turned off while cleaning control compartment to avoid shock or damage to the furnace.

Seasonal Cleaning

Before each heating season starts the furnace should be thoroughly cleaned of wasp and spider nests, lint accumulations and other debris. Debris will restrict air flow for combustion or bind up the combustion air impeller and not let the blower motor run. Check the burner and pilot orifices for debris also. Lint accumulations will cause the blower to become unbalanced and vibrate, restrict the ability of the blower to move air, and if blown onto the heat exchanger will cause odor and fire hazard. Contact your authorized dealer serviceman for annual cleaning.

See the manufacturer's operating instructions contained in your Owner's Packet.

WARNING: Do not store combustible or any other material in this area. Storage of any materials may restrict the air flow and affect the efficiency of your furnace or result in a fire.

Auxiliary Heater

The switch for the auxiliary heater is located on the dash. When the engine has reached the proper temperature and the auxiliary heater switch is turned on, the fan for the heater runs and forces warm air into the unit. The auxiliary heater is located in the rear of the unit.

WATER HEATER

CAUTION Before lighting water heater, be sure fresh water system is filled. Purge air from water heater by opening all faucets until water flows steadily from each.

Electronic Ignition

To ignite the burner, turn switch to ON position. The switch is located inside the vehicle, in the system monitor panel. If no flame is established within a 10 to 15 second period, the system automatically shuts down and goes into lockout. To reactivate the system, reset by simply turning the switch to OFF, then back to ON.

Motor Aid System

The motor aid system runs whenever you are running the engine of your motor-home. The heat from the engine is used by a heat exchanger in the water heater to begin heating the water.

Draining and Storage Instruction

If RV is to be stored during winter months, the water heater must be drained to prevent damage from freezing.

1. Turn off power & gas
2. Turn off pressure pump on water system.
3. Open both hot & cold water faucets.
4. Open drain on water heater.
5. Follow instructions for draining entire water system.

NOTE: Be certain to refill water heater with water before re-lighting.

Temperature and Pressure Relief Valve

The temperature and pressure relief valve is designed to open if the temperature of the water within the heater reaches 210° F, or if the water pressure in the heater reaches 150 pounds. Recreational vehicle water systems are closed systems and during the water heating cycle, the pressure build-up in the water system may reach 150 pounds. When the pressure is reached, the pressure relief valve will open and water will drip from the valve. This dripping will continue until the pressure is reduced to below 150 pounds, and the valve closes. This condition is normal and does not indicate a defective relief valve.

Burner Compartment Maintenance

Periodically check control compartment and screen in door to see that no foreign material has accumulated to prevent flow of combustion and ventilating air.

WARNING: Do not store or use combustible materials or liquids near or adjacent to this heater. The appliance shall not be installed in any location where flammable liquids or vapors are likely to be present.

IMPORTANT Read water heater operating instructions before using. Reset automatic safety lock-out by turning switch to OFF, Then ON.

FOOD CENTER / BLENDER

Operation

Your new blender has many convenient uses and can be operated in six dial speeds. For complete operating instructions refer to the information in your Owner's packet.

- Puree: Vegetables and fruits; Dial speeds 5 & 6
- Blend: Liquids, sandwich fillings and spreads; Dial speeds 1 through 6.
- Grate: Potatoes, onions, carrots, peppers, coconut, cheese and dry bread; Dial speeds 3 & 4.
- Beat: Eggs, cake and all purpose mixes; Dial speeds 1 & 2.
- Chop: Nuts, cooked meats and hard boiled eggs; Dial speeds 3 through 6.
- Whip: Egg whites, frosty drinks and cocktails; Dial speeds 3 through 6.

How To Clean

Wipe the top plate with a damp cloth and mild soap. Abrasives and scouring powders will destroy the luster of the stainless steel top plate and the speed control dial.

For cleaning instructions for the attachments refer to the pages in your owner's packet.

WASHER

NOTE: It is recommended when using your washer that you use the sewer hook-up!

Water Level Control

This water level control allows you to set the water level best suited for your particular load. Low uses approximately 5.6 gallons (21.2L) and is intended for very small wash loads. The high setting uses approximately 11.3 gallons (42.7L) and is for larger loads. The med position uses approximately 8.5 gallons (32.1L) and has been determined to be the setting most often used for average size loads. You may find this to be your most commonly used setting. For fewer permanent press wrinkles, higher water levels should be used.

CAUTION: Use low setting only when your wash load is small. Too many clothes and not enough water may result in clothes damage and water splashing out of the washer.

Water Temperature Control

This provides 5 different wash/rinse temperatures.

General Rules:

COTTON/STURDY -	Heavy, medium or light White cotton-Hot wash - warm or cold rinse Colored cotton-Warm wash - cold rinse
PERMANENT PRESS -	Heavy, medium or light White Perm. Press-Hot or warm wash - Cold rinse Colored Perm. Press-Warm wash - Cold rinse
KNIT -	Washable woolens-Warm wash - Cold rinse
DELICATE -	Delicate fabrics - Warm wash-Cold rinse

Generally a fabric should be washed in the warmest water possible without damaging color or fabric. To save energy, cold rinses should be used. Those cold rinse settings have been highlighted to help you save the cost of heating rinse water. Lab tests show that cold rinses are virtually as effective as expensive warm water rinses.

For the most wrinkle-free appearance of permanent press, synthetic and knitted fabrics, always use COLD RINSES.

Cycle Selector Control

This control is provided so you can select the desired cycle and wash time.

Push control knob in and turn to right only. Turning the knob to the left will un-

Pre-Wash

This cycle is designed for heavily soiled fabrics that need more than one washing.

It provides up to 2 minutes of agitation to loosen heavy soils. At the end of the cycle the soiled water is drained; clothes are given a high speed spin and the washer turns off. The clothes are then ready to go into the next wash cycle.

Pre-Soak

This cycle is designed for heavily soiled or stained fabrics that need more than one washing.

It provides 2 minutes of high speed agitation and 8 minutes of soak. This agitation and soak loosens dirt. Enzyme detergent may be necessary for certain types of stains.

From the Pre-Soak cycle the washer will automatically go into the Pre-Wash cycle.

Knit/Delicate

This cycle is designed for washable knits and washable, delicate fabrics.

It provides slow speed agitation. Spin speeds are slow to reduce wrinkles.

Two settings are provided in Knit/Delicate: Medium soil has a wash time of 8 minutes and Light soil has a wash time of 6 minutes.

In this cycle you may use just rinse and spin if you wish. Push the control in and turn to the right until the pointer is set at asterisk. For spin only set the pointer at line.

NOTE: For best results, always use cold water rinses to minimize wrinkling.

Cotton/Sturdy

Designed to wash sturdy fabrics such as towels, blue jeans, diapers, etc. At the end of the wash portion the laundry is rinsed by the washer refilling and agitating the load.

To remove even more detergent residue; sprays of fresh water are forced through the load by the high speed spinning action. High speed spins are used to overcome the absorbent nature of cotton. The result is a damp dry load.

Three settings are provided in Cotton/Sturdy. Heavy soil has a wash time of 12 minutes made up of 2 minutes of high-speed agitation followed by 10 minutes of low-speed agitation. Medium soil has a wash time of 10 minutes at low-speed agitation. Light soil has a wash time of 8 minutes at low-speed agitation.

Permanent Press

Designed to deliver permanent press items as clean and free of wrinkles as possible. During cool-down some wash water is drained and replaced by cold water. In warm water wrinkles in permanent press fabrics are loosened. In cool water fabrics tend to pick up fewer wrinkles during spin. This is why we use a cold rinse.

The spin portions are SLOW SPEED to minimize spin-created wrinkles.

Three settings are provided in PERMANENT PRESS. Heavy soil has a wash time of 10 minutes made up of 2 minutes of high-speed agitation followed by 8 minutes of low-speed agitation. Medium soil has a wash time of 8 minutes at low-speed agitation. Light soil has a wash time of 6 minutes at low-speed agitation.

In this cycle you may want to use just rinse and spin. Push the control in and turn to the right until pointer is set at asterisk. For spin only set pointer at line.

NOTE: For best results WATER LEVELS should be set at high.

WARNING: 1. Before you attempt to service your automatic washer always disconnect it from electrical power supply. 2. Never put dry cleaning or other flammable fluids, including items dampened with flammable fluids into your washer.

DRYER

Dryness Control

1. Turn control in either direction to the cycle and setting you want for proper drying of the kind of fabrics you have in each load.
2. You can turn control to an Off position to shut off your dryer at any time.
3. You can turn control at any time to make drying time longer or shorter.

The numbers on the dial show minutes for drying time. You must turn the control to the number of minutes of drying time you want.

Start Control

After dryness control is set and door is closed, push button to start dryer. Opening the dryer door stops the dryer. It will not start again until you close the door and push the start control.

Cool-down

Clothes are tumbled for a short time without heat at the end of the cycle to help reduce wrinkles and make clothes more comfortable to handle. Refer to description of cycle details.

End-Of-Cycle Signal

This signal buzzes at the end of the drying cycle. This is a reminder to unload the dryer immediately for best wrinkle free results. During Wrinkle Guard the buzzer will sound every 5 minutes.

Wrinkle Guard 1

This feature operates automatically at the end of the PERMANENT PRESS cycle. Its purpose is to keep your fabrics wrinkle free when you can't remove them from the dryer promptly at the end of the drying cycle.

After approximately 10 minutes of tumbling without heat the buzzer will sound. It will continue to dry for approximately 20 minutes if it is not interrupted by opening the door. During the 20 minutes the signal will buzz every 5 minutes.

Touch-Up Cycle

Designed to "smooth" synthetic and permanent press clothes that are dry but slightly wrinkled from being crowded in a suitcase or closet. This setting provides about 20 minutes of heated tumbling followed by 5 minutes cool-down.

1. Put just a few garments into dryer.
2. Set the dial to TOUCH-UP.
3. Push the Start Control.
4. Remove clothes immediately when End-Of-Cycle signal buzzes.

Air Cycle

Offers up to 18 minutes of drying time. No heat is added. Items are tumbled in room temperature air. Use this cycle to dry items that heat could harm (plastic, rubber, etc.) and to fluff and freshen things like feather pillows, etc.

Cotton/Sturdy Cycle

Provides up to 100 minutes of drying time with heat. At the end of the drying time there is an automatic 5-minute cool-down period.

Permanent Press Cycle

Provides up to 80 minutes of drying time with heat. At the end of the drying time there is an automatic 10-minute cool-down period. For most wrinkle-free results from permanent press items remove from dryer immediately after the cool-down period. If you do not open the dryer door at this point Wrinkle Guard 1 will start to operate.

Lint Screen

Keep the lint screen clean. A lint-clogged screen will slow down the flow of air. This makes drying time longer and wastes energy. You should clean the lint screen after each load. Here is how :

NOTE: If dryer drum is stained clean it with a damp cloth and mild detergent.

1. Pull out the screen and its cover.
2. Hold cover in one hand and the screen in the other...separate them by squeezing the screen and pulling on the cover at the same time (see illustration).
3. Roll the dry lint off the screen. DO NOT wet the screen or lint. Wet lint is very hard to remove.
4. Put the screen and cover back together and replace them in your dryer.

CAUTION: DO NOT USE YOUR DRYER WHILE THE SCREEN IS REMOVED. IT COULD CAUSE OVERHEATING AND POSSIBLE DAMAGE TO FABRICS AND DRYER PARTS OR CREATE A FIRE HAZARD. LINT SCREEN MUST BE PUSHED FIRMLY INTO PLACE.

NOTES

Lined paper with horizontal ruling lines and three binder holes on the right side.

EQUIPMENT

Generator	74
Roof Air Conditioner	75
Cab Air Conditioner	75
Kool-O-Matic Ventilator	76
Awning	77
Alarm System	77
TV Antenna	78
Cruise Control	79
Intec Car Vision	81
6-Way Power Seat	82
Swivel Seat Procedure	83
Kwikkee Electric Step	84
Aluminum Wheels	85
Front Air Bags	85

GENERATOR

Starting/Stopping Procedure-

Press the generator switch and hold until the engine is running, then release. Normally, the engine will start running within 5 seconds; however, if it fails to start after cranking 10 seconds, release the switch and wait a few seconds before cranking again. Whenever possible, allow a brief cooling period by running the set at **LOW-LOAD** or **NO-LOAD** for a few minutes just before shutting down. To stop, press the in dash generator switch and release, the set will stop. If the set shuts down automatically, press the safety reset button on the controller (Located inside the generator compartment) before attempting to restart.

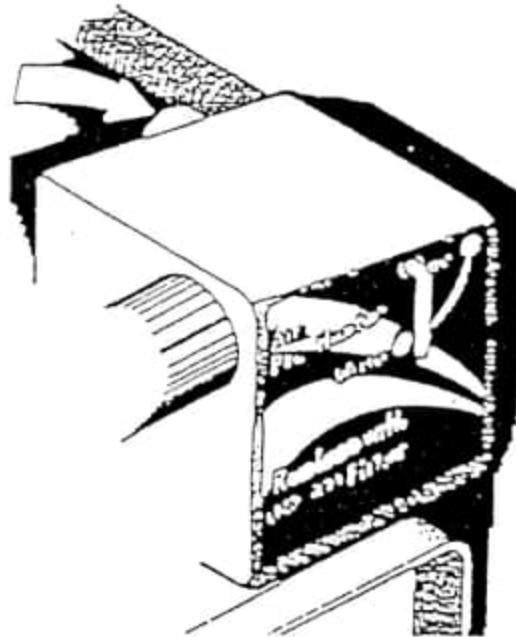

IMPORTANT: Read the generator operating instructions before using.

CAUTION: Check breather tube assembly (Air Vent) periodically for obstructions (dirt, insect nest & webs, etc).

Auto Transfer Switch

The auto transfer switch switches automatically from shore power to generator power when the generator is turned on. There is a 45 second delay after the generator is started before the coach electrical load is connected. This delay allows the generator to reach normal operating speed with no load.

ROOF AIR CONDITIONER

The Coleman roof-mounted air conditioner filters, circulates, cools and dehumidifies the air inside your vehicle. It operates only on 110V AC current from an outside source or onboard auxiliary generator. The small amount of water from dehumidification collects at the shroud plenum and is dispelled outside the vehicle.

Air Circulation

Set selector control to CIRCULATE, fan switch anywhere from LOW to HIGH. The unit circulates and filters inside air without cooling or dehumidifying.

Cooling Operation

Set selector control to COOL, fan switch anywhere from LOW to HIGH. Turn temperature control clockwise until compressor goes on. Adjust to your personal comfort level after initial cool-down.

Routine Service

Change or clean the filter every two weeks while the unit is in daily operation. Wash in hot, soapy water; rinse clean. The sealed compressor unit does not require lubrication. The blower motor may require oiling on some models.

CAB AIR CONDITIONING

Your vehicle's air conditioning system was installed by the chassis manufacturer on most models and is warranted by the manufacturer as described in their Owner's Manual. Refer to it for operating instructions.

Some Suggestions

When parking your motorized vehicle for long periods on very hot days, open the driver's window about half an inch and open a roof vent to prevent heat build-up.

When the interior is overheated, run the unit for a few minutes with the windows open. This permits the hotter air to escape and allows a quicker cool down.

For quickest cooling, set the A/C controls on RECIRCULATE or MAXIMUM.

Low engine speed, direct sunlight and high humidity slow down the cooling rate.

Operate the A/C for a few minutes each week during the winter to lubricate the compressor shaft seal.

NOTE: Cab air conditioning on Class A's is NOT factory (GM) installed and is warranted separately by the manufacturer - refer to the cab air Owner's Manual and Warranties. If you should have a problem with your Class A cab air, the toll free number for Frigi-Cool is 1-800-527-0839.

KOOL-O-MATIC[®] VENTILATOR

Operating the Model RV-12

Be sure the dampers are open when operating the Kool-O-Matic[®] Ventilator to prevent overheating the controls.

Windows or other air intakes should be open during ventilator operation to permit proper air flow ventilation and control cooling.

The Model RV-12 uses a thermostat control to adjust the Kool-O-Matic[®] Ventilator. Use this to control which of the two fan speeds for the preferred ventilation level.

Thermostat Control

The thermostat control panel has a 3 position switch. Use this switch to select the desired fan speed, HIGH, OFF and LOW. The thermostat dial is operated in a similar fashion to your air conditioner at home. If it is too warm, turn the dial so it points to a lower temperature.

Example: The thermostat is set at 75° F. The fan will operate while the temperature remains above 75° F or higher. The fan will shut off if the temperature drops more than 2 degrees below the temperature set on the dial.

To turn off the ventilator, you need to press the switch to the middle position. This provides a power cut-off to prevent accidental operation.

Cold Weather Use

A plastic grille cover has been provided for use on the interior vent area. This cover is used for preventing back-drafts during fall or winter use of your recreational vehicle.

Simply close the dampers place the cover over the grille assembly. The cover is held in place by the magnetic strips attached inside the cover.

Winter Storage

During long-term storage of your recreational vehicle, the cover should be removed and the dampers opened for ventilation to help control condensation inside the recreational vehicle.

AWNING

For information on your awning, please refer to the manufacturer's information in your owner's packet.

What to Do When It Rains

Your best protection for the awning during a storm is to have it rolled up. In light rains, we suggest the following:

1. Lower the rear arm and raise the front arm to place the canvas on a tilt. The awning must be adjusted to allow adequate runoff. Allow more tilt for larger size awnings.

IMPORTANT: The awning must be tilted enough to prevent water pooling and subsequent damage. Damage by pooling of gusty winds is not covered under the limited warranty.

If the awning must be rolled up wet, be sure to dry it as soon as possible to prevent mildew and damage.

ALARM SYSTEM

Operating Tips

When arming/disarming the alarm system from a distance, aim the transmitter straight at your vehicle. If you point your transmitter at a metal object the signal will be reflected.

Do not attempt to arm/disarm the system when your vehicle is around a corner from you, or if it is surrounded by several other vehicles. Do not hold the transmitter button down. This will only succeed in draining your battery.

Operating Instructions

TO ARM/DISARM YOUR ALARM - The transmitter allows you to arm/disarm from a distance of 100 feet or less.

ZERO ENTRANCE DELAY - There is no entrance delay. When tampering is detected and the system is armed, the activation is instant.

TRANSMITTERS - The micro-transmitter supplied with your system has been digitally pre-coded.

SWITCH SENSING - The AL 450 activates by sensing the opening and closing of door pin switches.

ARM/DISARM CONFIRMATION - When the AL450 is armed, you will hear it "chirp" once. The red LED under the front T.V. will blink. When you disarm the system it will chirp 3 times.

T.V. ANTENNA

The Winegard T.V. is designed for all channel color and black-and-white reception. If reception is poor, make sure the power supply switch is on and the connectors are tight. Should reception remain poor, check with your authorized dealer.

Operating Instructions

Before raising antenna, check for clearance above the vehicle.

1. To raise the antenna to operating position, turn crank toward UP until you feel resistance. Switch the power to ON.
2. To rotate antenna, pull down on rotating knob with both hands until it disengages the ceiling plate. Turn the antenna for the best picture and sound. Do not rotate antenna except in the full UP position.
3. To lower the antenna, first align the pointer on the ceiling plate. Then turn the crank toward the down position with the pointer on the ceiling plate. Never lower antenna to any position without first aligning pointer.

DO NOT FORCE!!

WARNING: Do not raise antenna near overhead electric wires as contact may cause serious injury.

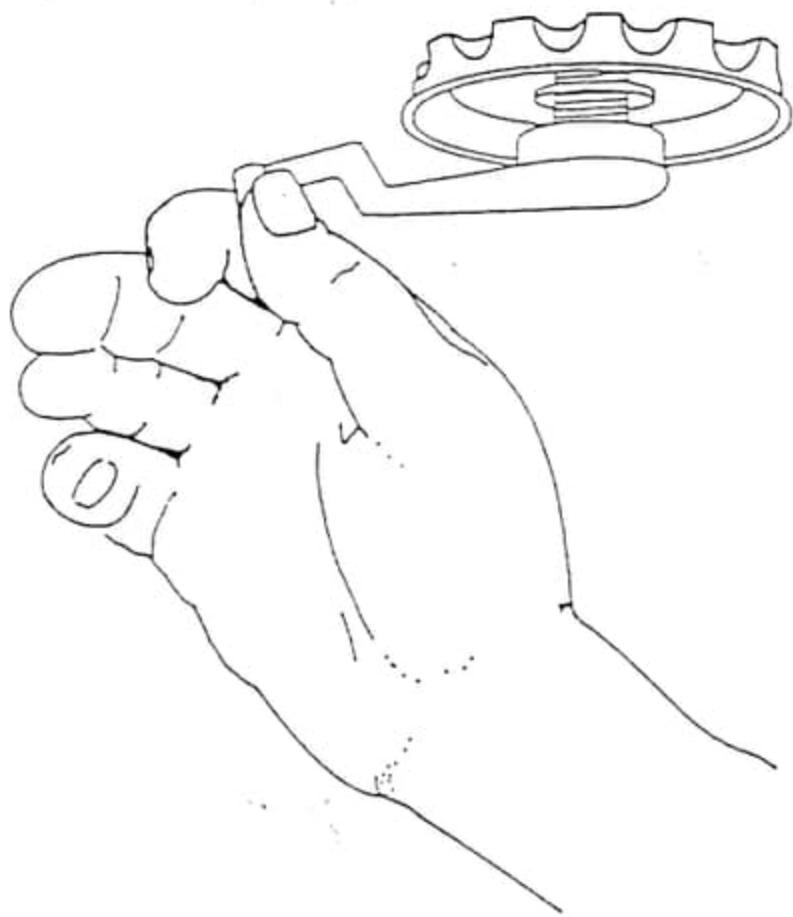

Raising the Antenna



Rotating the Antenna

CRUISE CONTROL

Operating Instructions

The controls on the smart switch are used to operate the wipers, turn signals and headlight dimmer

Cruise Control

In the regulator of your Speed Control is a safety switch which will not let the system operate until your vehicle is moving above a pre-selected low speed. At the factory this Low-Speed Switch is set to close at approximately 20 mph. It should however, be checked during the road test.

SET SPEED - Move the slide button on the control switch to the ON position and drive at any speed above 20 mph at which you want automatic control. Hold that speed with your foot while you press and release the Set/Coast button. One second after release, remove your foot from accelerator pedal. You can increase your speed at any time with the accelerator pedal. When you release the pedal you will return to the set speed.

ACCELERATION - Hold the slide button in the Resume/Accel position and your vehicle will accelerate until you release it, then your vehicle will slow to your set speed and again control there. If you want to make the higher speed your new set speed, release the slide button when you reach the speed you want, and as you do quickly press and release the Set/Coast button.

COAST - When you press and hold the Set/Coast button you erase the set speed from the regulator's memory and allow the vehicle to coast. Just before you reach the lower speed you want release the button and it will control there providing it is above the low speed setting.

DISENGAGE - Depress the brake pedal and you are in control of the vehicle's speed. You can also disengage the Speed Control by pushing the slide button to OFF but, this erases the set speed from the regulator's memory.

RESUME - When you disengage the system with the brake you do not erase the set speed from the memory even if you come to a complete stop. To return to your chosen speed, drive to a speed above 20 mph then move the slide button to the Resume/Accel position and release it. The Speed Control will take you back to your set speed and control there.

If the rate of acceleration is faster or slower than you like, use the accelerator to obtain a speed close to the set speed then slide button to Resume/Accel position and release it.

CAUTION: Do not use your speed control on slippery roads or in heavy traffic.

There is no drain on the battery when the ignition switch is off, even if the cruise control switch is left on.

Wiper-Washer Operation

Move the slide button to the WASH position and release, wash solution is delivered with an approximate 5 second wipe cycle to follow. A demand wash & wipe is performed as long as the WASH button is activated.

Headlight Beam Change and Turn Signals

Move the multi-function lever upward for a right-hand turn signal and downward for a left-hand turn signal.

Compress the handle to switch from low to high beam, or high to low beam.

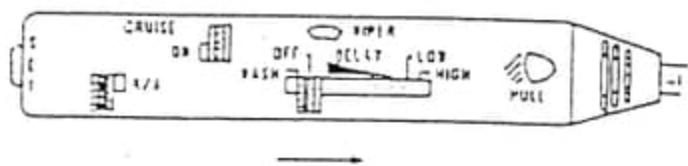
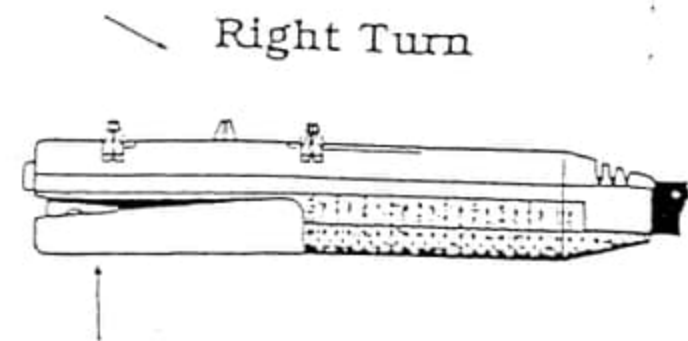
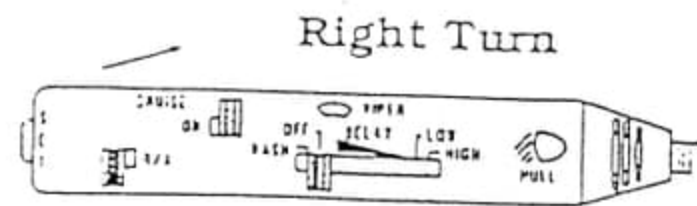

Windshield Wipers and Wiper Delay

Move the slide button from OFF to DELAY, you will get a wipe and a delay between wipes (ranging from 45 seconds to 2 seconds) as the slide is moved further to the right.

A continuous LOW speed or HI speed wipe can be obtained by moving the slide button to the appropriate position.

Moving the slide to the OFF position stops the wipers and puts the wiper motor in PARK position.

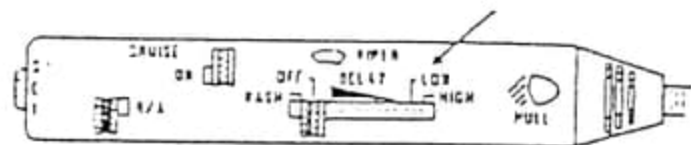

INTEC CAR VISION

Power

Your Car Vision has been installed so that the ignition key will also control your Car Vision.

Upon starting your vehicle, the Car Vision will require approximately 20 seconds to warm up. After which your unit will be ready to operate instantly.

Operation

- a) On-SB Switch: Before starting your vehicle, put switch in the SB (stand by) position.
- b) Day-Night Switch: Set the switch in the proper position in accordance with the lighting conditions available at the time of use. This switch adds the auxiliary lighting to the system during low light or night hours.
- c) When the unit is in the SB position, certain circuits of the camera and monitor are constantly kept warm to effect an instant on for use when the unit is needed.
- d) A picture will appear on the monitor as follows:
 1. When the vehicle is put in reverse "R".
 2. When the switch (a above) is switched from SB to the ON position.
- e) Contrast and Brightness Controls

These controls should not require adjustment during normal use, but when lighting conditions are at their extremes, minor adjustments may be in order to obtain the most usable picture.

NOTE: Do not put Contrast and Brightness controls in their maximum position for this will overdrive the respective circuits affecting the quality of the picture.

Rear View Monitoring During "R" Reverse Operation

- a) Picture will appear on monitor almost instantly upon putting transmission into the reverse position.
- b) The Day-Night switch should be put in the NIGHT position when auxiliary lights are required. In this position the lighting will automatically come on when the transmission is put in the reverse position.

Viewing During Forward Operation or When Vehicle Is Stationary

- a) Move On-SB switch to the ON position. A picture will appear almost instantly on the monitor.

6 - WAY POWER SEATS

The switch for the power seat is located on the right hand side of the passenger's seat.

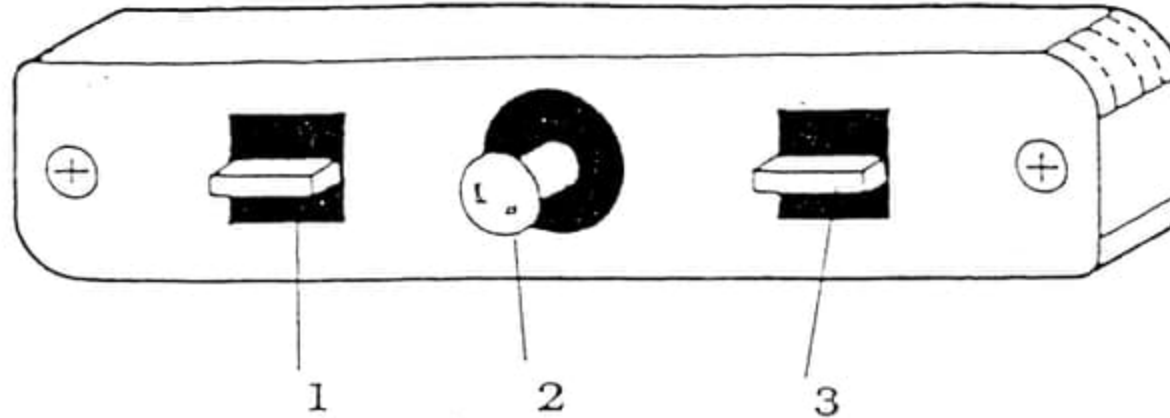

SWITCH #1 Push the switch up to raise the back of the seat and push the switch down to lower the back of the seat.

SWITCH #2 Move the lever up to raise the complete seat. To lower the seat, move the lever down. This lever also moves the seat back and forth.

SWITCH #3 Raises the front of the seat up and down.

NOTE: The thermal breaker for the electric seat is located in the battery compartment on all units.

SPOT LIGHT

Power to the spot light is supplied from the fuse panel located behind the instrument cluster.

Bulb Replacement

Loosen screw and remove bulb retaining ring. Disconnect wires from the faulty bulb. Connect wires to the new bulb. Install bulb and fasten with bulb retaining ring.

Use bulb #GE-4700 Marine 13 Volt

SWIVEL SEAT PROCEDURE

1. Be sure the seat is moved completely forward.

Note: Lever (A) is omitted with the power seat option.

2. Bring the back of the seat to the full upright position.

Note: Lever (B) is on the recliner seat only.

3. Put the arm rests in the horizontal position.

4. Slide the swivel lever (C) back to allow the seat to swivel.

Note: The seat may have to be adjusted forward or backward when swiveling.

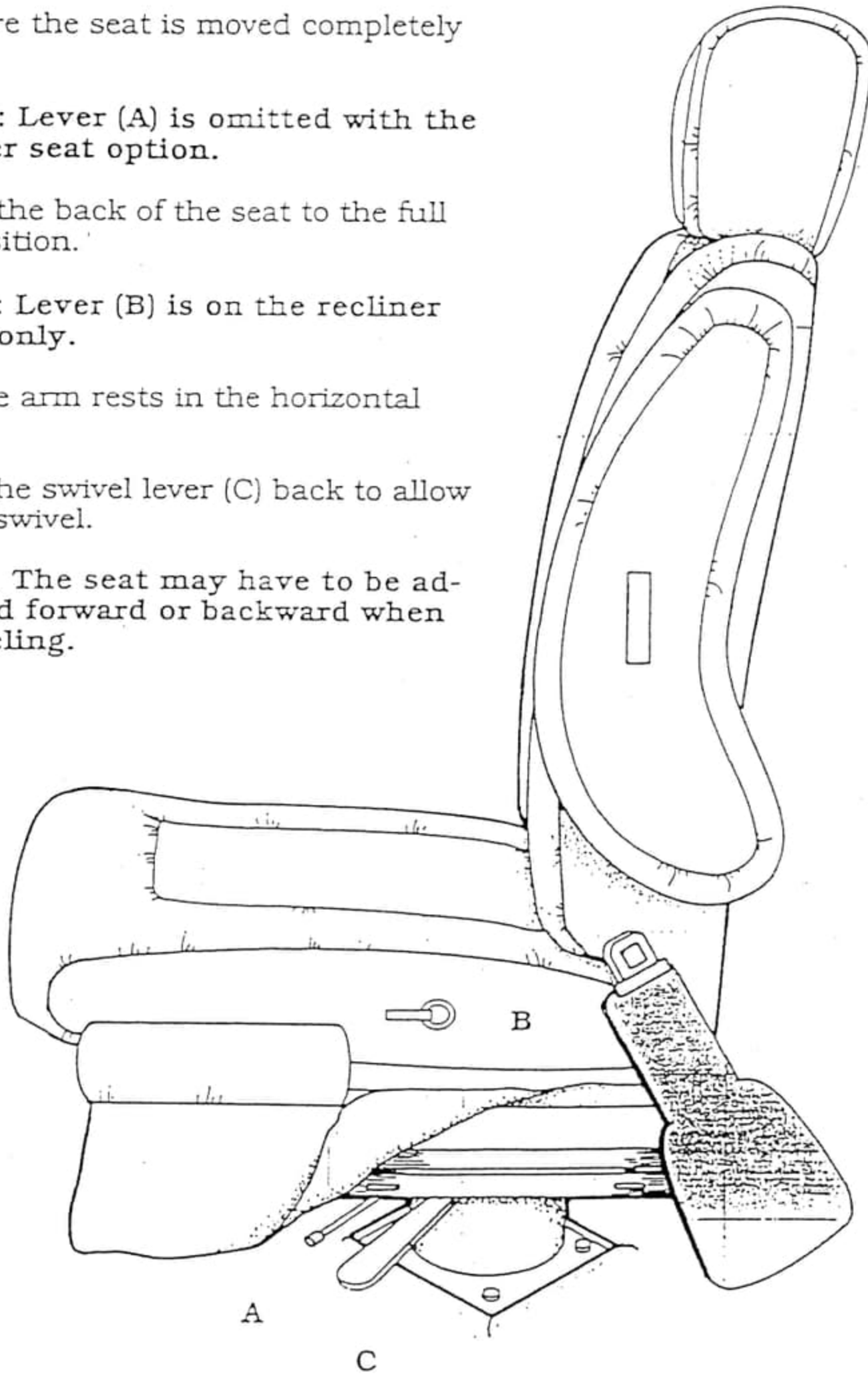

Operating Instructions:

1. After the installation is complete and with the entrance door open, turn the power switch ON.
2. Close the door. The step should retract and lock in the up position.
3. Open the door. The step should extend and lock in the down position with the understep light on. Note: The understep light is not available on all step models.
4. Turn the power switch OFF. The step should remain in the extended position with the understep light off when the door is closed. This procedure can also hold the step in the retracted position.
5. With the power switch OFF, the step extended and the entrance door closed, turn ON the vehicle ignition. The ignition safety system will go into effect and the step will automatically retract.

NOTE: If the step fails to automatically retract, turn the power switch ON, then open and close the entrance door to manually retract the steps. If you drive with the steps in the extended position there is a possibility of causing major damage to both the step and your vehicle.

6. Turn the vehicle ignition OFF and open the door. The step will extend and lock in the out position. This is known as the "last out feature".

WARNING: If the door is opened and closed without allowing the step to fully extend and lock in the out position, the step will retract and lock in the up position. When the door is re-opened, the step will not extend. The power switch must be turned on off the door closed the re-opened for the step to extend.

The "last out feature" is operative only the first time the door is opened after the vehicle ignition is turned off.

7. When the vehicle ignition is ON, the step will always activate with the door movement, regardless of the power switch position.

Lubrication and Maintenance

Clean all mud, salt, and road grime from the step before lubricating. Lubricate all moving parts (bearings, pivot points, slides, clevis pin, and drive linkage ball) every thirty (30) days with a good quality moisture and heat resistant penetrating grease. Kwik-Lube Spray Grease is specially formulated to lubricate Kwikkee electric steps and is recommended for lubricating all moving parts.

FRONT AIR BAGS

Optional Easy Access Air Bag Fill

Access to the valve stems for the front air bags is gained through the front access door on Class A Motorhomes. Fill each side to 60 psi.

The front coil springs on a Chevrolet chassis have air bags in the center with a "tire" valve at the bottom. These air bags should be filled to 50PSI.

ALUMINUM WHEELS

If your unit is equipped with aluminum wheels, be sure to clean and wax them on a regular basis, since these wheels are subject to corrosion without proper care.

NOTES

A series of horizontal lines for writing notes, with three binder holes punched along the right edge.

WATER SYSTEMS

City Water Hook-Up	88
Water Tank Fill	88
Water Pump	88
Condensation	89
Disinfecting System	89
Water Purifier	90
Water Heater By-Pass	91
Waste Drainage System	92
No-Fuss Flush System	93
What Not To Do	94
Toilet Operation	95
Winterizing	96

FRESH WATER SYSTEM

It's hard to imagine how much water you use every day when you are at home. Newcomers to self-contained camping vehicles soon discover that water doesn't last very long unless consumption is reduced drastically. For instance, you can use much less water for showering if you wet down; turn off the water for soaping; then turn on the water to rinse. This way a good shower takes a gallon or less. There's plenty of water to meet your needs once you adjust your habits.

CITY WATER HOOK-UP

Simply connect the hose to the source, open the valve and you have pressurized the faucets, toilet, and water heater. Open the faucets to purge the trapped air from the water system before lighting the water heater.

CAUTION: Some water sources develop excessive pressure, particularly in mountain regions.

Water pressure regulators are available to protect your camping vehicle system against high pressure. See your dealer for more information.

WATER TANK FILL

Connection to the water storage tank is a 1-1/4" flexible plastic tube. Simply remove the cap, pull the vent plug, insert your garden hose and fill. The water supply to service points is then provided by the pump.

WATER PUMP

The water pump is totally automatic and self-priming, operating on demand when water is used. To start the pump follow these steps:

1. Check water level in tank; refill if necessary.
2. Open all valves and faucets (except drain valves).
3. Switch on power to pump and wait for water lines and hot water tank to fill.
4. Close each faucet when it delivers a steady stream of water (cold water faucets first).
5. Check pump to see if it stops when all faucets are off.
6. Pump is now ready for automatic operation. It will start when a faucet is opened and stop when the faucet is closed. (Sometimes there is a brief delay, especially when an "air cushion" accumulator is used).
7. Do not allow pump to run when water supply tank is empty. Continued operation with dry tank will blow circuit fuse and/or damage pump.

CONDENSATION

Condensation is a natural occurrence. The amount will vary with the climate conditions, particularly the relative humidity. Condensation occurs because there is water vapor present in the air, which each of us adds by breathing, bathing & cooking, etc. The water vapor collects wherever there is available air space, and when the temperature reaches the 'dew point' the water vapor in the air condenses and changes to liquid form. Most people have experienced a similar phenomenon when moisture forms on kitchen windows, bathroom mirrors, etc. during the cooler weather.

Proper ventilation and, if needed, the use of a de-humidifier in your unit will assist in controlling the condensation. Condensation causes dampness, mildew, staining and if allowed to continue at high-levels, may cause damage to the panelling, ceilings and floor structures.

Crank open vent or window to assist ventilation, when the furnace is use.

As condensation is not the result of a defect, damages incurred from condensation are not covered by the Holiday Rambler Corporation Limited Warranty.

DISINFECTING THE FRESH WATER SYSTEM

Follow this procedure if the system is new and has not been used for sometime or may have been exposed to contamination.

1. Prepare a chlorine solution using one gallon of water and 1/4 cup of chlorine bleach (sodium hypochlorite solution). Pour into empty tank using 1 gallon for every 15 gallons of tank capacity. This mixture gives a 50ppm (parts per million) residual chlorine concentration in the vehicle's water system.
2. Fill tank with drinking water. Open each faucet in turn and run the water until you smell a distinct chlorine odor. Do not forget the hot water taps or the tub/shower faucets. Be sure the water heater bypass is in the normal mode.
3. Allow the system to stand at least four hours when disinfecting with the 50ppm solution. To speed up the process, use the 100ppm concentration and let stand at least an hour.
4. Drain system and flush with drinking water. Repeat if necessary to clear strong chlorine taste or odor from the system.

CAUTION: Chlorine solution concentrations exceeding recommended levels may damage the water system.

WATER PURIFIER

Your Everpure® Water Purifier helps to disinfect and filter your drinking water, making it clean, taste-free and odorless. It will add to the pleasure, comfort and safety of your RV.

Super-chlorination is a simple procedure which the traveler can easily follow. Using ordinary household laundry bleach (sodium hypochlorite) is used for super-chlorination. This familiar product (Clorox, Purex, Sun-Brite, etc.) is not often thought of as a water disinfectant but it is a common form of sodium hypochlorate (chlorine). Thousands of people with wells depend on it for protection from harmful water borne organisms.

A traveler can easily add chlorine to a water tank when adding water. It's easiest to add the bleach to the "fill" hose before filling the tank. Use 1/6 ounce (1 teaspoonful) of chlorine bleach to each 10 gallons of water filled. This doses the water with 6.7 ppm (parts per million) chlorine, the recommended dosage for the quick-kill of harmful bacteria, viruses and slime-forming organisms.

Because chlorine imparts an offensive taste and odor, and super-chlorination requires a high concentration of this chemical, most people would object to using as much chlorine as needed when filling their water tanks. This is why the U.S. Environmental Protection Agency (EPA) suggests super-chlorination/dechlorination. With this method, the taste and smell of the chlorine are removed from the water following disinfection. A water filter using activated carbon is ideal for this purpose.

Maintenance

Your water purifier has been installed in your unit with-out its cartridge, follow the simple instructions that come with the cartridge. A cartridge replacement is needed when the flow of water from your faucet becomes too slow for convenience. If the cartridge is not changed, eventually the flow will stop entirely. It would be wise to carry a spare AC "Quick Change" cartridge with you while traveling.

Even when a decreasing flow does not demand it, at least one cartridge change a year is recommended.

Winterizing

The QC flush plug that comes with your water purifier should be put into the QC2 crown and locked into place. After the anti-freeze is flushed from the line, the QC Flush plug must be removed and the cartridge should be inserted into the crown of the purifier.

WATER HEATER BY-PASS

The top and bottom valves on the By-Pass should be closed and the center valve could be open to by-pass the water heater.

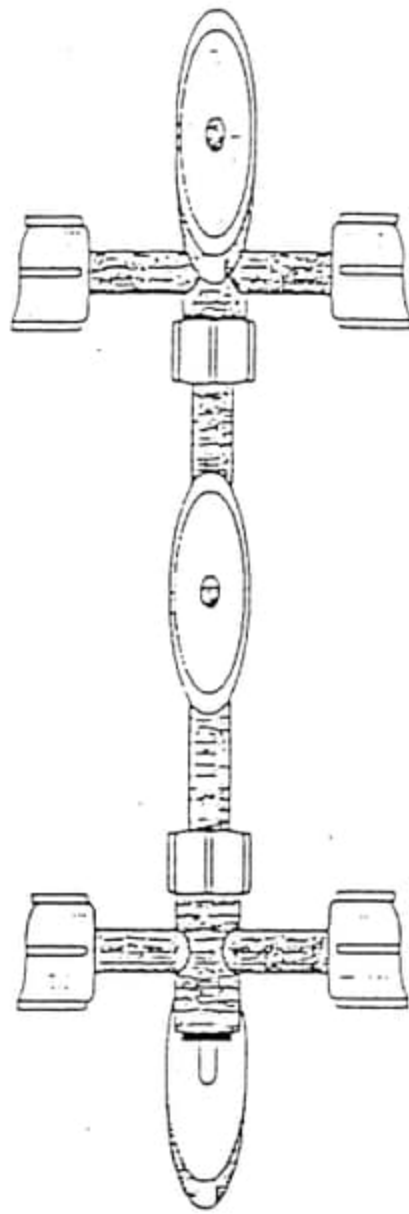

Normal Mode

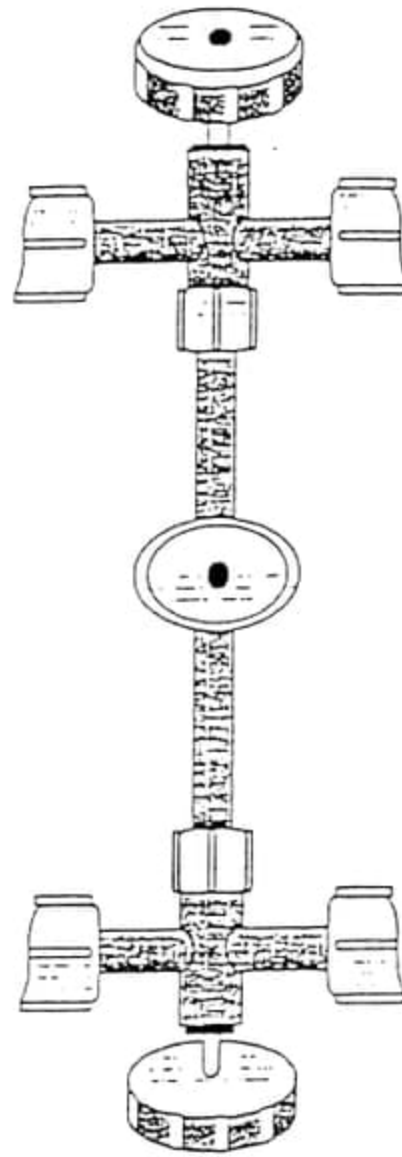

By-Pass Mode

WASTE DRAINAGE SYSTEM

General Information

Your waste drainage system was designed to provide adequate and safe storage and/or discharge of waste materials. All the materials used in the fabrication of the system, appliances and fixtures connected there are tested by a nationally recognized testing laboratory. Installation of these materials is accomplished by approved methods. The entire fabricated waste system is factory tested in accordance with the American National Standards Code A119.2

The drainage system uses properly sized ABS plastic piping and fittings connected to the sinks, toilet and holding tanks and provides for their drainage to an outside termination. All fixtures incorporate the use of "P" traps to provide a water seal against entry of sewer gases from outside connections. The RV should be reasonably level for best operation of the system.

There are two separate systems, one for waste water ("gray" water) and one for sewage wastes (black water). Each has its own control valve; but on most models, both empty through the same drain outlet.

SEWAGE WASTE SYSTEM

Sewage Holding Tanks

The sewage or "black water" holding tank is located directly beneath the toilet. Before using, treat the tank with a gallon of water containing an odor control chemical in the toilet. Be careful not to spill the chemical on your hands, clothing or carpet since it may cause a permanent stain. Depress the toilet pedal to allow mixing with the toilet water. Continue to depress the pedal until about a gallon of water has entered the waste tank. Release the pedal and the waste tank is ready for use.

To empty the tank connect your drain hose (supplied by the owner) to the drain fitting. Pull the gate valve with a continuous motion. When the tank is empty, follow with a fresh water rinse and close the valve. Prime with an odor control chemical.

Waste Water System

The drain outlet is engineered for quick-release attachment of the drain hose adapter fitting or the end cap. Always push the gate valve in and secure the end cap in transit to prevent leakage (required in some states).

Proper Waste Disposal

Most states and parks have strict regulations about discharging wastes except into authorized disposal systems. Dumping raw sewage from toilet holding tanks except at authorized dumping stations is universally prohibited. Illegal dumping along road sides by a minority of recreational vehicle users has resulted in tough laws, and has unfairly labeled all camping vehicle travelers as unwelcome visitors in some areas.

Most state, national and private parks have either a central dump facility or campsite hook-up for sewage. You'll find lists of dump stations from coast to coast in *Woodall's Campground Directory*, *Trailer Life's RV Campground and Services Directory*, *Rand McNally's Campground and Trailer Park Guide*, *Good Sam/Park Directory* (Good Sam Club) and other publications. Some major oil companies offer dump facilities at selected stations. Plan ahead, and you'll find little inconvenience in the proper, legal disposal of holding tank wastes.

When Connected to the Sewer Hook-up

Keep the holding tank gate valves closed at all times, except when dumping. Before emptying, be sure there is enough liquid in the tank to provide a smooth flow through the gate valve and drain valve. Sufficient liquid in the tank causes a swirling action that should take with it accumulated solid wastes.

Avoid accumulation of solid wastes in either tank. Do not leave gate valves open or partly open when connected to sewer. RV flush toilets use very little water. If the valve is left open, solid wastes accumulate in the tank. Eventually, this will result in an unpleasant cleaning job or costly repairs.

NO-FUSS FLUSH SYSTEM

Waste Holding Tank Flushing System, (Optional)

1. Connect sewer hose.
2. Open drain valve; let the tank empty.
3. Attach garden hose* to the water inlet labeled "Sewer Valve must be open when using this water inlet" and flush for about 2 minutes or until the water runs clear from the discharge hose.
4. Disconnect the garden hose from the faucet and lay on the ground to allow water to drain from the system before detaching from the water inlet.

DO NOT ALTER THIS SYSTEM IN ANY WAY, SUCH AS BY ADDING CHECK VALVES, etc.

*Do's and Don'ts for the No-Fuss Flush

DO use the same procedures used at most campground dump stations.

DO NOT use the same hose to fill your potable (fresh) water tank that is used for the No-Fuss Flush.

WHAT NOT TO PUT IN HOLDING TANKS

- Do not flush facial tissues, they are treated chemically to give them wet strength and they will not dissolve like toilet paper. Special "holding tank tissues" are available at most R.V. supply stores. Also, white toilet paper dissolves faster than colored papers.
- Do not use strong detergents or full strength bleaches to deodorize and disinfect, use an odor control chemical made especially for holding tanks.
- Do not put automotive antifreeze, ammonia, alcohol or acetone in holding tanks. Some chemicals will dissolve plastic.
- Do not put large table scraps in the tanks. They could get stuck in or damage the gate valve seals.

NOTE: In subfreezing weather use a recommended amount of holding tank antifreeze.

NOTE: When traveling, we recommend not to have the holding tanks more than 1/2 full.

ACCUMULATOR TANK

The accumulator tank smooths water flow and reduces ON/OFF cycling of the pump by lessening the variation in pressure and flow between the pump and the outlet in the system. This ON/OFF cycling reduces the battery drain and gives longer pump life.

Purging the Accumulator Tank

1. Shut off the pump power.
2. Open a low point drain.
3. Open the valve at the top of the accumulator tank until all the water has drained out.
4. Close the tank valve and close the low point drain.
5. Switch on the power, leaving the faucet furthest from the pump "open" until flow settles. Close all the faucets. Pump will then reach required pressure and shut off automatically. System is now charged for service.

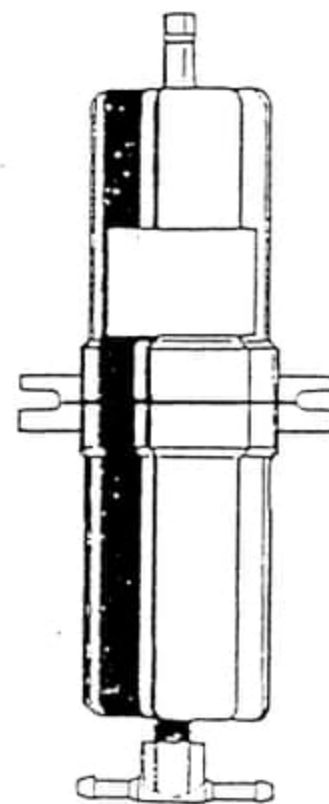

TOILET OPERATING INSTRUCTIONS

The toilet in your unit is a fresh-water flush type, using high velocity water injection to produce a "swirl effect" in the bowl. To add water to the bowl, step on the small pedal. To flush, step on the large pedal until the water swirls. If toilet is the lever type, see the manufacturer's operating instructions in your Owner's Packet.

Toilet Maintenance

To clean the toilet, use any good quality, non-abrasive cleanser. Avoid highly concentrated or acidic household cleaners which might damage the rubber seals.

If the sealing blade operates less freely after extended use, apply a light film of silicone spray. This does not apply to the knob-type toilet.

Trouble Shooting

Water running - the blade is not closing completely, so the water control valve is partially open. Probably the sealing groove is clogged. Use a coat hanger hook, or a similar device to clear the sealing groove. Be careful not to damage the rubber seal. For knob-type toilet, check the ball valve.

Pedal sticking - Apply a light silicone spray to the blade.

NOTE: It is a good idea to place a few sheets of tissue at the bottom of the bowl each time before using.

WINTERIZING A WATER SYSTEM

Winterizing calls for draining the entire system completely. Built-in check valves make it impossible to empty the pump and tank by blowing the lines. Instead do the following:

1. Open the drain valves for the water tank, hot and cold water lines and hot water heater. (If your unit has an ice-maker, there are additional drain valves under the sink and behind the ice-maker.)
2. Remove the output hose at the pump. Turn on the pump to expel the remaining water, approximately a cupful. A towel or a rag should be sufficient, to absorb the water. Now the lines can be blown out by applying compressed air at the pump outlet hose.
3. System is winterized. Re-attach output hose before refilling system.

Alternate method: Use a potable antifreeze solution. Simply follow the directions on the label.

WARNING: Use only antifreeze made specifically for potable water systems. Automotive antifreeze, if ingested, can cause blindness, deafness or death.

COLD WEATHER USE

Your unit was not designed for extended use in sub-zero (below 32° F) weather. However, you may get along satisfactorily if the temperature does not drop too low. Interior water lines, fixtures, water storage tank and pump are normally protected from moderate to freezing temperatures as long as the furnace operates. Exposed drain lines may freeze quickly. If in doubt, winterize with a potable anti-freeze.

INTERIOR/EXTERIOR CARE

Exterior Care	98
Leiberglass Care	98
Masks	98
Outside Storage	99
Windows	99
Entrance Door Adjustment	99
Interior Care	
Upholstery	100
Draperies & Sheers	100
Bedspreads	100
Countertop	101
Doors & Drawer Fronts	101
Tub & Lavatory	101

EXTERIOR CARE

The exterior of your camping vehicle is pre-finished aluminum used for its durability and beauty. Wash it frequently with a mild soap in lukewarm water. If you travel roads that have been salted to remove ice, wash your vehicle as soon as possible. A good automotive cleaner/wax should be used occasionally to remove tree sap, road tar, insects and industrial fall-out that may damage the surface. DO NOT use Naphtha or Turpentine!

We recommend your unit be washed about every four weeks and waxed in the spring and fall. To make sure your new unit is protected with wax immediately have your dealer wax it just prior to delivery.

NOTE: Aerosol cans of spray enamel are available from your dealer, for use on the steel chassis parts. DO NOT use on the Alum./Exterior

We suggest you check the sealants around the doors, windows and external seams frequently. If sealant is cracked or dried out it should be replaced with new material to prevent leakage. Sealants can be purchased from your Holiday Rambler® dealer.

FIBERGLASS CARE

Crazing (minute cracks in the fiberglass) is a normal characteristic for fiberglass. It can be repaired by using a filler, sanding and repainting with gel-coat (a fiberglass repair kit can be ordered through any Holiday Rambler dealer, use part #12 001 555).

MASKS (STONE GUARD)

CAUTION: Trapped moisture under a mask can cause clouding of some painted finishes. Your mask is constructed of breathable, mildew resistant vinyl to help allow moisture that may collect from rain, dew, or other reasons to pass through the mask rather than remain trapped. Nevertheless, we strongly recommend the removal of your mask immediately if the underside becomes wet and the mask and vehicle be allowed to dry completely before reinstallation. (If clouding of your paint finish does occur because of trapped moisture, warranty coverage will not apply).

Care of Your R.V. Mask:

We recommend you treat your mask with a good quality vinyl wax prior to use. To clean your R.V. mask simply use a mild detergent and rinse well. After washing allow mask to completely dry and treat with a vinyl wax. Your R.V. mask is made of the highest quality material available and can withstand many hours of exposure to the sun. However, it is recommended that you remove the mask before storing the vehicle.

OUTSIDE STORAGE COMPARTMENTS

The outside storage compartments are not waterproof. Please store items accordingly.

WINDOWS

The all season windows in your motorhome normally open and close easily. If the tracks become clogged with dirt, clean them with a small stiff brush and spray with a silicone lubricant.

ENTRANCE DOOR ADJUSTMENT

The entrance door has a built-in camber adjustment on the latch side. A rod anchored at the inside top of the door has a threaded at the bottom. The adjusting hex nut is reached at the bottom edge on the latch side.

If the door does not close tightly at both the top and bottom corners, tighten the hex nut. Most doors need no adjustment. Do not adjust the door except when necessary.

NOTE: If the door can not be adjusted by the door rod, take your unit to your authorized dealer for service. Continued use may damage the door, and such damage is not covered by the warranty.

Periodic maintenance of the door is needed. The door jamb corners should be inspected and resealed if necessary. We recommend inspection and resealing at least once every six months.

INTERIOR CARE INSTRUCTIONS

Fabrics: Upholstery for sofa & pillows, Dinette cushions, Living area chairs, Driver/Passenger seating, valance board inserts, and Imperial window treatments.

All of your upholstery has been treated with SCOTCHGARD® to prevent overall water spots and soiling. Please use common sense and treat your furniture as you would at home. Remember, your vehicle is a small living area, so soiling may occur more frequently and will probably need more attention than your furniture at home. Please follow these guidelines for cleaning your upholstery fabrics.

Water base cleaners are not recommended. If a spill does occur, blot up the spot, but do not rub it in. Some solvents are not recommended since they may have an adverse reaction to the specific backings of your upholstery fabric. To prevent overall soil, frequent vacuuming or light brushing to remove dust and grime is recommended. Spot clean, using a mild water-free solvent or dry-cleaning product. Clean only in a well ventilated area and *avoid* any product containing carbon tetrachloride or other toxic materials. Pre-test a small area before proceeding. Use a professional furniture cleaning service when an overall soiled condition has been reached.

A reminder: Your upholstery fabrics have been manufactured with the highest quality as you would expect to find in furniture stores. However, if abused, it is not completely resistant to possible damage. Again, common sense is needed when your unit is exposed to a very humid climate for an extended period of time, or if your unit is closed up in a very hot climate for an extended period of time. However, if you know you are going to be away for a long period of time, cover the upholstery and make sure the window covering are down to protect from any damage. The same covering should be used if you are planning to be gone and the climate is exceptionally humid. This will protect the fabric from any unnecessary exposure to moisture.

Bedsread / Draperies / Bedroom Valance Fabric / Headboards

We recommend dry cleaning of your bedsread and privacy drape just as you would your draperies or bedsread at home. Although this is more expensive, proper care of the material will help insure a longer life. The care of the headboard and bedroom valance fabric should be followed with the same instructions as the Upholstery fabrics. Laundering and improper cleaning may result in the fabric shrinking or deteriorating prematurely.

Linoleum

Use mild cleaners and warm water for routine cleaning. Waxing is not necessary, since this is a no-wax vinyl product.

Ceiling Material, Imperial

The Imperial padded vinyl ceiling has been treated with a protective finish to ensure a soil resistant surface. A mild, non-abrasive cleaner and soft cloth is recommended.

Wall Coverings / Dash Board Vinyl / Ceiling Material

Your decorative wall coverings are not much different than the vinyl wall-paper which you may have in your own home. It should be cleaned with a non-abrasive cleaner. It is made of vinyl and it can be easily maintained with proper care.

Solid Wood Cabinetry/ Refrigerator Panels/Walls/Doors

These products should be cared for as you would for any fine piece of wood furniture. Apply a furniture polish when you clean your vehicle to maintain the natural beauty and luster of the wood. This will keep your cabinetry looking new and from drying out.

Carpet

Your carpet is woven with DuPont Teflon stain resistors built right in. Dry chemical or dry cleaning is recommended for major cleaning. Frequent vacuuming is recommended for daily accumulations. For specific stain cleaning instructions please refer to your Carpet Care Guide, provided in your Owner's Packet.

Counter-tops

Made of high pressure laminate, the counter-tops are quite easy to keep clean. Waxing is not necessary. Glass rings, food spills, water spots and smudges usually wipe off with a damp cloth or sponge. Stubborn stains can be removed with a spray cleaner.

The laminated surface resists alcohol, fruit acids, cosmetics and most household chemicals. It is better to avoid contact with dyes, strong laundry bleaches and bluing. Indelible inks used on food packages may stain so take care when unpacking groceries on a damp countertop.

Sharp knives can damage the finish so confine slicing to a good cutting board.

The countertop resists heat and even boiling water. Pots and pans straight from the oven or broiler should go on hot pads. Keep irons on the ironing board and lighted cigarettes in an ashtray.

For lasting beauty avoid using harsh abrasives, scouring powders, peroxide or bleaches. These can dull the surface and make it more likely to stain the next time.

Bath Fixtures

Clean your tub/shower, sinks and toilets as you would at home. A non-abrasive cleaner is recommended. When cleaning mirrors or shower doors, vinegar and water works very well to remove hard water spots and stains.

Care for these as you would at home by using a kitchen cleaner.

Venetian Blinds

Your blinds will stay new looking by just using a soft cloth and cleaner.

Hardware/Accessories/Clocks/Light Fixtures

Wipe clean as you would for daily cleaning. Use a non-abrasive cleaner to avoid damaging the finish.

HARDWOOD SINK COVERS

Because of the humid environment where the sink covers are used, special care is required to keep them looking like new.

After using the sink covers, wash it and allow it to dry thoroughly. Do not lay the cover on a flat surface where moisture will be trapped underneath. Once the cover is completely dry, rub in a coating of vegetable oil on both sides and especially the edges. Do not use petroleum based or synthetic oil because the cover comes in contact with food particles.

Periodic applications of the oil will help in maintaining the sink covers in a like new condition. If the vehicle is to be stored for any length of time, (such as winter), it is a good idea to apply a generous coating of oil just prior to the storage, and then again when it is being readied for use.

VEHICLE MAINTENANCE

Imperial Class A Chassis Information	104
Imperial Mini-Home Chassis Information	105
Aluma-Lite Class A Chassis Information	106
Aluma-Lite Mini-Home Chassis Information	107
Warranty Information	108
Bulb Charts	109
BTU Ratings	110
Holding Capacities	111
Lubrication & Maintenance Schedule	112
Fuel Stabilizer	115
Winter Storage Checklist	114
Serial Numbers	116
Inventory of Personal Property	117
Maintenance Record	118

1990 IMPERIAL MOTORHOME CHASSIS INFORMATION

Model	27,28	29	31	33, 34, 35	37
Chevy/GM - 178" Wheelbase	NA	S	NA	S	NA
Chevy/GM - 158" Wheelbase	S	NA	NA	NA	NA
Gillig Chassis-208" Wheelbase	NA	NA	NA	NA	S
Chevy 454-4BBL-V-8 Engine	S	S	S	S	NA
460-4BBL Ford V-8 Engine	NA	NA	NA	NA	S
Fuel Tank Capacity (Approx. Gal.)	60	60	60	60	78
Electric Fuel Pump	S	S	S	S	S
Rear Dual Wheels	S	S	S	S	NA
4.56:1 Rear Axle Ratio					
Rear Dual Wheels	NA	NA	NA	NA	S
4.78:1 Rear Axle Ratio					
7 Radial Tubeless Tires - D Load Range	S	S	NA	NA	NA
9 Radial Tubeless Tires - D Load Range	NA	NA	S	S	NA
9 Radial Tubeless Tires - Load Range F					S
Positrim Front Suspension w/Stabilizer Bar	S	S	S	S	Frt Air Susp'n.
Tag Axle w/Mor Ryde [®] Susp'n	NA	NA	S	S	S
Dual Output 135AMP Alternator	O	O	O	O	S
Delco 105 AMP Alternator	S	S	S	S	NA
Automatic Transmission	S	S	S	S	S
Auxiliary Start Switch	S	S	S	S	S
Power Steering	S	S	S	S	S
Tilt Steering Wheel	S	S	S	S	S
Cruise Control	S	S	S	S	S
Automotive Air Conditioner	S	S	S	S	S
Hydraulic Brakes	S	S	S	S	S
Tinted Windshield	S	S	S	S	S

1990 IMPERIAL MINI-HOME CHASSIS INFORMATION

Model	27
Ford Chassis - 158" Wheelbase	S
Ford 8 Cylinder - 460 Cu. In. Engine	S
Rear Dual Tubeless LT215/85R/16D	S
Tires w/16" Wheels*	
Tag Axle Mor/ryde [®] Suspension	S
Heavy Duty Alternator (100 AMP/Ford)	S
Automatic Transmission	S
Auxiliary Start Switch	O
Power Steering	S
Tilt Steering Wheel	S
Cruise Control	S
Automotive Air Conditioner	S
Hydraulic Brakes	S
Tinted Windshield & Front Door Glass	S
Fuel Tank Size (Gallons)	36

* Tire Size May Vary

1990 ALUMA-LITE CLASS A CHASSIS INFORMATION

Model	25	27, 28	29	31	33, 34, 35
Ford Chassis- 158" Whlbase	S	NA	NA	NA	NA
Chevy Chassis - 178" Whlbase	NA	NA	S	NA	S
Chevy Chassis - 158" Whlbase	NA	S	NA	S	NA
Ford 8 Cyl.-460 Cu. In. EFI Engine	S	NA	NA	NA	NA
Chevy 454 - 4BBL V-8 Engine	NA	S	S	S	S
Electric Fuel Pump	S	S	S	S	S
Rear Dual Wheels					
4.10:1 Rear Axle Ratio	S	NA	NA	NA	NA
4.56:1 Rear Axle Ratio	NA	S	S	S	S
Radial Tubeless Tires					
LT215/85R/16D w/16" Wheel	S	NA	NA	NA	NA
7-8R x 19.5 D Load Range	NA	S	S	NA	NA
9-8R x 19.5 D Load Range	NA	NA	NA	S	S
Positrim Frt Susp'n w/Stab'r	NA	S	S	S	S
Air Supplement (Rear)	O	NA	NA	NA	NA
Air Helper Springs	NA	S	S	NA	NA
Tag Axle Mor/Ryde [®] Susp'n	NA	NA	NA	S	S
Dual Exhaust System	NA	S	S	S	S
Hi Output 135AMP Alternator	NA	O	O	O	O
Heavy Duty 100AMP Alternator	S	NA	NA	NA	NA
Delco 105 AMP Alternator	NA	S	S	S	S
Automatic Transmission	S	S	S	S	S
Auxiliary Start Switch	S	S	S	S	S
Power Steering	S	S	S	S	S
Tilt Steering Wheel	S	S	S	S	S
Cruise Control	S	S	S	S	S
Automotive Air Conditioner	S	S	S	S	S
Hydraulic Brakes	S	S	S	S	S

1990 ALUMA-LITE MINI-HOME CHASSIS INFORMATION

Model	24RB	24SB	26	27
Ford Chassis - 158" Wheelbase	S	S	NA	S
Ford Chassis - 176" Wheelbase	NA	NA	S	NA
Ford 8 Cylinder - 351 Cu. In. Engine EFI-V8	S	S	NA	NA
Ford 8 Cylinder - 460 Cu. In. Engine EFI-V8	O	O	S	S
Ford Fuel Tank Capacity (Approx. Gal.)	36	36	36	36
Rear Dual Wheel 4.10:1 Rear Axle Ratio	S	S	S	S
Radial Tubeless LT215/85R/16D Tires* w/16" Wheels (Spare Optional)	S	S	S	S
Tag Axle Mor/ryde® Suspension	NA	NA	NA	S
Single Axle Air Supplement (Rear)	O	O	O	NA
Heavy Duty Alternator (Ford 100 AMP)	S	S	S	S
Automatic Transmission	S	S	S	S
Auxiliary Start Switch	O	O	O	O
Power Steering	S	S	S	S
Tilt Steering Wheel	S	S	S	S
Cruise Control	S	S	S	S
Automotive Air Conditioner	S	S	S	S
Hydraulic Brakes	S	S	S	S

*Tire Size May Vary

IMPORTANT WARRANTY INFORMATION

Please review your Holiday Rambler Limited Warranty and all owner's manuals and any separate warranties before you require service.

Often there is confusion over what equipment is installed by Chevrolet and what is installed by Holiday Rambler. This handy reference sheet will explain the components most frequently confused with Chevrolet's equipment. All equipment listed below (except the A/C Compressor and condenser, which are GM) is installed by Holiday Rambler or their suppliers and is NOT covered under your Chevrolet Warranty.

Cruise Control- Perfect Circle/Dana 800-GET DANA

Alternator - Lestek (For assistance away from HR dealers, call toll free (800-433-7628)

Cab Air Conditioner Frigi-Cool -except compressor and condenser which are GM. For help or nearest service center, call 800-527-0839.

Mor-ryde Suspension

Tag Axle and Brake Booster (33' only)

Shocks-Front-4-way (Std. on 31, 33, 34, 35 only-other have Chevrolet shocks.)

Shocks Tag axle - Mor-ryde coil shocks

NOTE: Drive axle shocks are Chevrolet equipment

Isolator Relay Delay

Dash Instruments - Imperials Only

Aluminum Wheels

Wipers, Exhaust Extensions

Radio Antenna

Except Frigi-Cool[®] cab air conditioners, all of the components listed will be serviced by your authorized Holiday Rambler[®] dealer. When optional equipment is not ordered, standard Chevrolet equipment is used. When optional equipment is not ordered, standard Chevrolet equipment is used. Most dealers work by appointment only to provide owner's with the most efficient service. Please call the service manager in advance to schedule your appointment. While any authorized dealer will perform warranty service, we recommend that you return to the dealership that sold you your unit because of their continued and personal interest in you. If you are touring or have moved, contact any authorized dealer.

If assistance is needed in locating a dealer or obtaining technical advice, contact the Consumer Affairs office at 219/862-7278 (7:30 - 4:00 EST Monday through Friday).

EXTERIOR BULB CHART

Location	Bulb No.
Tail-Stop & Direction	1157
License Plate Light	1895
Clearance Light	194
Step Light	57
Back-up Lights	1156
Off Door Patio Light & Under Alcove	1003
Grab Handle	1141
Turn Signal Light	1157

INTERIOR BULB CHART

Location	Bulb No.
Wardrobe Light	5114
Bullet Light	1139
Deluxe Reading Light	921
Dinette Light	1141
Cosmetic Light	20-99
Fluorescent Light - 20"	F15T8-CW
Slide-out	PL-9
Side Light	20-75
Table Lamp	100A

B.T.U. RATINGS

Appliance	B.T.U.	Models Affected
Furnace	25,000	Std. 24' A/L Mini
Furnace	31,000	Std. 27SB A/L Mini Std. 27SB Imp. Mini
Furnace	32,000	Std. 26, 27WB Imp. Mini Std. 30-35' Imp. Class A Std. 26, 27WB A/L Mini Std. 25WB, 30-35' A/L Class A
Furnace	41,000	Std. 37 Imp. Class A
Range - Magic Chef	29,800	Std. Imp Class A & Mini
Air Conditioner	13,500	All

HOLDING CAPACITIES

Appliance	Capacity	Models
Water Heater Electronic Ignition	6 Gal	Std. Class A, Except 37' Std. Mini
Water Heater Electronic Ignition	10 Gal.	Std.Imp. 37' Class A
Fresh Water Tank		
	27 Gal.	24RB, 26SB Mini
	31 Gal	26RB, 27SB Mini
	35 Gal.	27WBLK Mini
	50 Gal	27WBXS, 29WBXS Class A
	54 Gal.	27WB Mini
	55 Gal	25WB, 28WB, 33CS, 34CS, 34WB Class A
	70 Gal	31WBXS, 33CSXS Class A
	84Gal	35CSXS, 37CBXS Class A
Gray Water Tank		
	22 Gal	24RB, 26RB 27SB Mini
	27 Gal	25WB, 28WB, 33CS, 34CS, & 34WB Class A 26SB, 27WB Mini-home
	35 Gal.	27WBXS, 29WBXS Class A 27WBLK Mini-home
	56 Gal	31WBXS, 33CSXS, 35CSXS, 37CBXS Cl. A
Waste Water Tank		
	22 Gal	25WB Class A
	25 Gal.	27WB Mini
	27 Gal	28WB Class A; 24RB Mini
	35 Gal.	27WBXS, 29WBXS Class A
	38 Gal	31WBXS, 33CSXS, 33CS, 34CS, 34WB, 35CSXS, 37CBXS Cl. A
L.P. Gas Tank		
	16 Gal.	All Mini-homes
	27 Gal	27WBXS, 29WBXS, 31WBXS, 33CSXS, 35CSXS Class A
	30 Gal.	28WB, 33CS, 34CS, 34WB Class A

NOTE: Approximate Capacities

LUBRICATION AND MAINTENANCE SCHEDULE

EVERY WEEK

- Check coach battery water level. Add distilled water, if necessary.

EVERY MONTH:

- Clean exhaust fan filter and blades.
- Check gas lines for leaks with soap solution, or with leak detector.
- Check tire pressure, and wear.
- Test smoke alarm
- Check operation of windows, latches & hinges.

EVERY 50 HOURS

- Clean air conditioner filter

AFTER EVERY 2000 MILES

- Adjust brakes. Check lines.
- Check steering for noise or play
- Change oil and filter (initial 2,000 miles only)
- Check radiator and hoses for leaks
- Check belts for tension and/or cracks.
- Check all fluid levels
- Check, clean, tighten battery cables.
- Lube all steering joints/fittings
- Check exhaust system for leaks.
- Check seals on transmission, differential, and wheels

EVERY 5000 MILES or 6 MONTHS

- Lubricate ext. door locks with silicone.
- Rotate tires.
- Clean window and door seals with a mild soap; spray with silicone lubricant.
- Reseal seam around bath tub if needed
- Check gas appliances for proper operation, check gas lines for leaks with soap solution or leak detector
- Inspect and reseal entrance door jamb corners
- Lubricate movable parts on entrance step
- Change oil and filter

EVERY 5000 MILES or 6 MONTHS, (cont'd)

- Drain air tanks and check complete system
- Check parking brake function
- Check fuel tank mounts and fuel line.
- Check exhaust hangers & clamps
- Check tightness/wear on engine, transmission, and radiator mounts.
- Check tightness of lug nuts inside and out. Check wheels and nuts for cracks
- Check wheel bearing adjustment
- Have LP system checked by authorized dealer.

EVERY 10,000 MILES OR 1 YEAR:

- Flush the fresh water system
- Check roof seams for any cracks in tape and replace if needed.
- Check brake lining
- Check front end alignment

Normal use of the camping vehicle may cause certain fittings and fasteners to loosen due to road vibrations and excessive use. Periodic inspection and maintenance should be performed on these items.

If your camping vehicle is placed in extended storage, check it periodically. Batteries must be charged periodically even if they are not used.

Refer to the chassis owners's manual concerning lubrication and maintenance of the chassis system.

WINTER STORAGE CHECKLIST

FRESH WATER SYSTEM

- PLUMBING LINES Drain and protect by filling with approved RV antifreeze.
- WATER HEATER Drain.
- TOILET Drain and depress pedal until antifreeze appears in bowl.
- WATER TANK Drain & add RV Antifreeze
- WATER FILTER (If equipped) Remove filter & install winterizing plug.

BODY AND TIRES

- BODY Clean and wax. Oil the locks and hinges. Repair roof seams as needed. Remove heavy, wet snow accumulation with a push-broom.
- TIRES Block up the RV with wooden blocks or manufactured jack-stands on a hard, level surface. Partially deflate the tires. Cover to protect from sunlight.

INTERIOR CARE

- COUNTER-TOPS & CABINETS Wash with a mild soap and water.
- CURTAINS Remove and clean - according to care specifications.
- WINDOWS Mask with newspapers

DRAINAGE SYSTEM

- HOLDING TANK Drain and rinse. Close valves. Add a small amount of anti-freeze to keep valves & gaskets lubricated.
- DRAIN TRAPS Pour a cup of R.V. antifreeze down all drains.

L.P GAS SYSTEM

- REGULATOR Cover to keep moisture out.
- CYLINDERS Consult your L.P. service center for winterization of L.P. system. Wash and touch up the paint.

Electrical Systems

BATTERIES Add distilled water and recharge if needed. Disconnect the cables. Remove batteries and store in a cool, dry place. Check and recharge as needed.

Appliances

REFRIGERATOR Clean. Leave both doors propped open. Cover exterior panels and roof vents.

AIR CONDITIONER Remove air filters and clean or replace them. Cover the shroud.

OVEN\ RANGE Close the latch on the exterior range hood vent.

FUEL STABILIZER

Any fuel is made up of many different organic compounds. These organic compounds are constantly changing and over time become new compounds that change the characteristics of fuel. These organic compounds change and can form gummy residues or varnish-like films that can clog up passages in fuel lines, and injectors. We recommend that a fuel stabilizer be added to your unit if the unit will be stored for more than three months.

CAUTION: Do not overfill the fuel tank. When the automatic pump fill kicks off, do not continue to hand pump fuel into the tank. Overfilling the fuel tank uses up the air space needed for expansion of the fuel and proper venting and can result in fuel fumes inside the vehicle, excess pressure build-up in the tank or overflowing of fuel.

CAUTION: Fuel line deterioration can occur with a long periods of storage.

SERIAL NUMBERS

Record numbers here for future reference:

Motorhome Serial Number

Chassis Serial Number

Door Key

Trunk Key

Range Model & Serial Number

Microwave Model & Serial Number

Refrigerator Model & Serial Number

Furnace Model & Serial Number

Water Heater Model & Serial Number

Generator Model & Serial Number

Model & Serial Number of Optional Equipment

When writing to the Consumer Affairs Department, or to a component manufacturer, be sure to include your camping vehicle serial number *and* other pertinent numbers listed above.

CONSUMER AFFAIRS DEPARTMENT

HOLIDAY RAMBLER CORPORATION

65528 State Road 19

Wakarusa, Indiana 46573

219/862•7278 or 219/862•7211

INVENTORY OF PERSONAL PROPERTY

<u>Item</u>	<u>Serial No.</u>	<u>Value</u>
•		
•		
•		
•		
•		
•		
•		
•		
•		
•		
•		
•		
•		
•		
•		
•		
•		
•		
•		
•		
•		
•		

INSURANCE

Company _____

Policy No. _____

Agent's Name & Address _____

Business Phone _____ Home Phone _____

Emergency Phone _____

HOLIDAY RAMBLER RECREATIONAL VEHICLE CLUB, INC.

400 Indiana Avenue P.O. Box 587, Wakarusa, Indiana 46573 Phone:219/862-7330

Dear Owner:

Membership in the Holiday Rambler Recreational Vehicle Club is limited to the owners of Holiday Rambler Corporation produced family camping units. The owners of Holiday Rambler, Holiday Ramblette, Monitor, Monitor-Lite, Aluma-Lite, Trail-seeker, Free Spirit, and Wide World RV units are invited to join our club.

The Holiday Rambler Recreational Vehicle Club is one of the fastest growing camping vehicle clubs in this country. Our active members represent all 50 states, Canada and Mexico. We have over 300 active chapters throughout the country - one in your area, most likely - planning local camp-outs and get-togethers and helping to make family camping even more enjoyable. Club members camp and travel together much like a large family.

In addition to the local chapter activities, the HRRVC provides state and region rallies along with a program of national activities. Each year we provide our members with a program of vacation rallies and caravans within the USA and to Mexico and Canada and of course our big International Rally.

The idea behind Holiday Rambler Recreational Vehicle Club, a non-profit organization, is to provide year-round opportunities for members to enjoy good fellowship and pleasant use of their camping vehicles. Club members are called Holiday Ramblers® and by their very nature they help give recreation vehicle camping a good name. Goals of the club are "to foster friendship among camping vehicle owners; to set an example of courtesy on the highway and of model conduct at meeting sites and in public campgrounds; to encourage the growth of family camping vehicle facilities in the United States; to disseminate advisory and education information to its members and the public; and to encourage county, state and federal agencies to provide more and improve existing family camping vehicle parking areas at reasonable rates."

Our informative newspaper, The Holiday Ramblings™, is published by the club office. News of national, regional, and state activities, along with articles by local chapter members, help keep all members up to date on special events and travel tips.

Join today! The Holiday Ramblers await the pleasure of your company. If a membership application card did not come with your R.V., please write or call us at the above address and we will send you our current brochure. After processing your application, we will forward your identification numbers, club decals, club patches, and membership roster.

We await the opportunity of sharing our many activities with you and the chance to enjoy your fellowship.

Respectfully,

HRRVC Executive Director

CHANGE OF OWNER/ADDRESS

Serial No. _____

NAME _____

ADDRESS _____

CITY _____ STATE _____ ZIP _____

CHANGE OF OWNER CHANGE OF ADDRESS

If your address changes or you sell your unit, please complete the above information and mail it to:

Holiday Rambler Corporation
65528 State Road 19
Wakarusa, IN 46573
Attn: Consumer Dept.

NOTE: We cannot change records without the serial number of the unit.

CHANGE OF OWNER/ADDRESS

Serial No. _____

NAME _____

ADDRESS _____

CITY _____ STATE _____ ZIP _____

CHANGE OF OWNER CHANGE OF ADDRESS

If your address changes or you sell your unit, please complete the above information and mail it to:

Holiday Rambler Corporation
65528 State Road 19
Wakarusa, IN 46573
Attn: Consumer Dept.

NOTE: We cannot change records without the serial number of the unit.

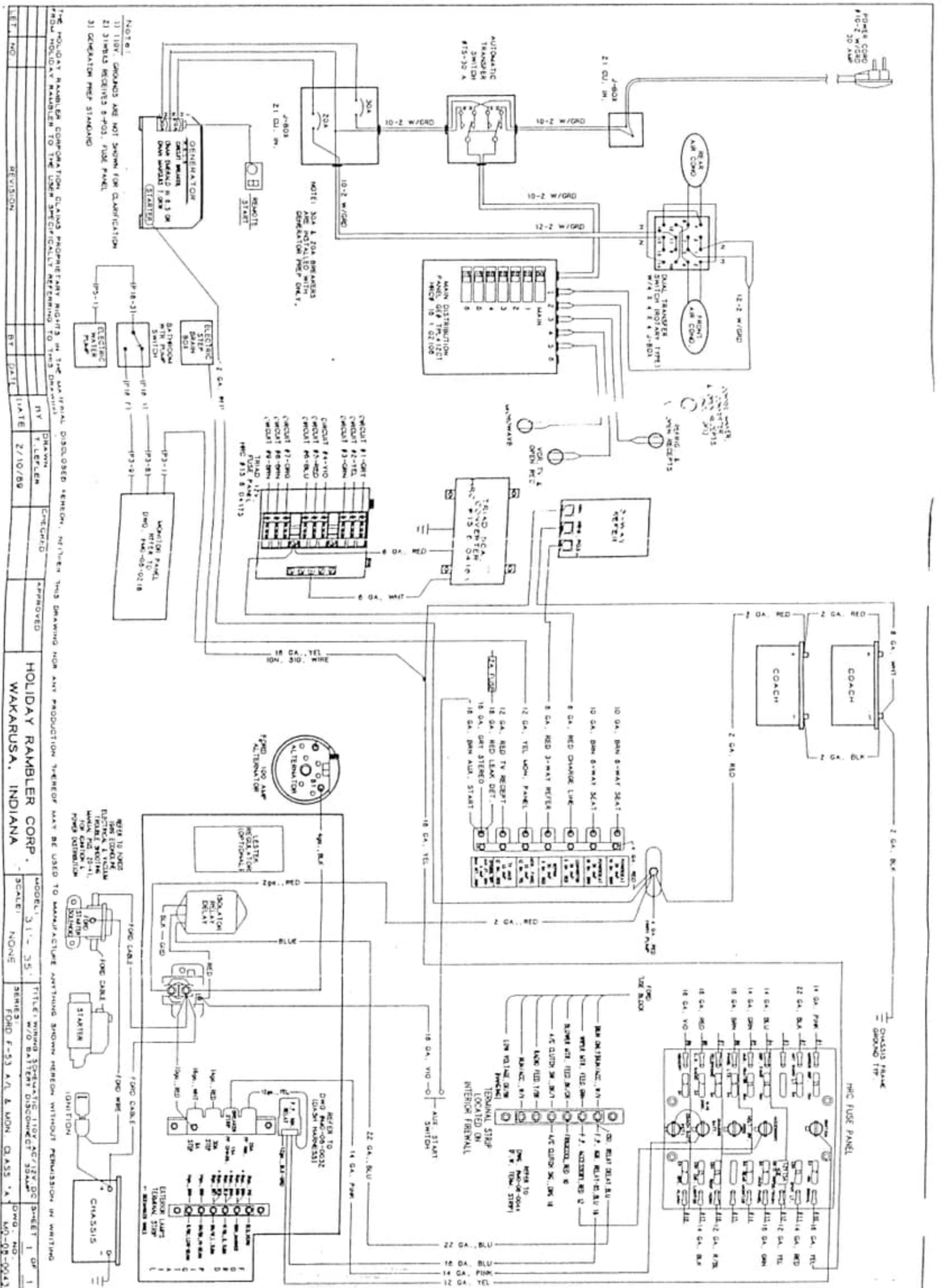

NOTE:
 1) 100V GROUNDS ARE NOT SHOWN FOR CLARIFICATION
 2) 21 SIMBLES RECEIVES 8-POLE FUSE PANEL
 3) GENERATION FROM STANDING

THE HOLIDAY RAMBLER CORPORATION CLAIMS PROPRIETARY RIGHTS IN THE MATERIAL DISCLOSED HEREON. NOTHING THIS DRAWING HOW ANY PRODUCTION THEREOF MAY BE USED TO MANUFACTURE ANYTHING SHOWN HEREON WITHOUT PERMISSION IN WRITING FROM HOLIDAY RAMBLER TO THE USER SPECIFICALLY REFERENCING TO THIS DRAWING.

REV. NO.	REVISION	BY	DATE	CHK'D	DATE	APPROVED
1		F. L. LEM	2/10/89			

HOLIDAY RAMBLER CORP.
WAKARUSA, INDIANA

MODEL: 311-35
 SCALE: NONE
 SERIES: FORD F-33 A.V. & MON. CLASS 'A'
 SHEET 1 OF 1
 DWG. NO. MD-01-0043

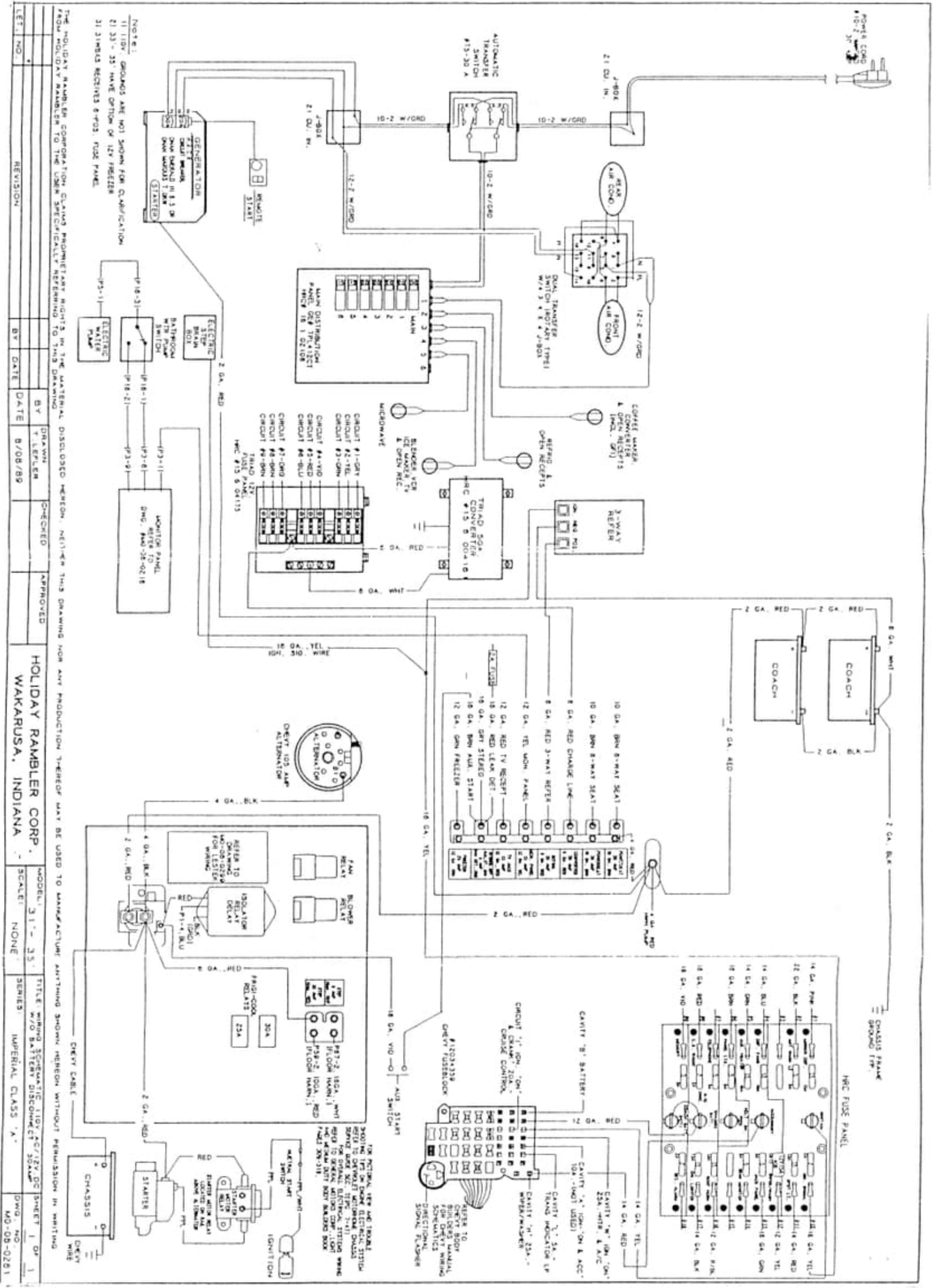

NOTE:
 1) 110V. GROUNDS ARE NOT SHOWN FOR CLARIFICATION
 2) 23" - 25" HAVE OPTION OF 12V FREEZER
 3) 21MBLS RECEIVES 6-P03. FUSE PANEL

THE HOLIDAY RAMBLER CORPORATION CLAIMS PROPRIETARY RIGHTS IN THE MATERIAL DISCLOSED HEREON. NEITHER THIS DRAWING NOR ANY PRODUCTION THEREOF MAY BE USED TO MANUFACTURE ANYTHING SHOWING HEREON WITHOUT PERMISSION IN WRITING FROM HOLIDAY RAMBLER TO THE USER SPECIFICALLY REFERENCING TO THIS DRAWING.

LET. NO.	REVISION	BY	DATE	BY	DATE	APPROVED
		T. LEBER	8/08/89			

HOLIDAY RAMBLER CORP.
WAKARUSA, INDIANA

MODEL	SCALE	SHEET	SERIES	IMPERIAL CLASS
31" - 35"	NONE	1 OF 1		A

DWG. NO. MD-08-0281

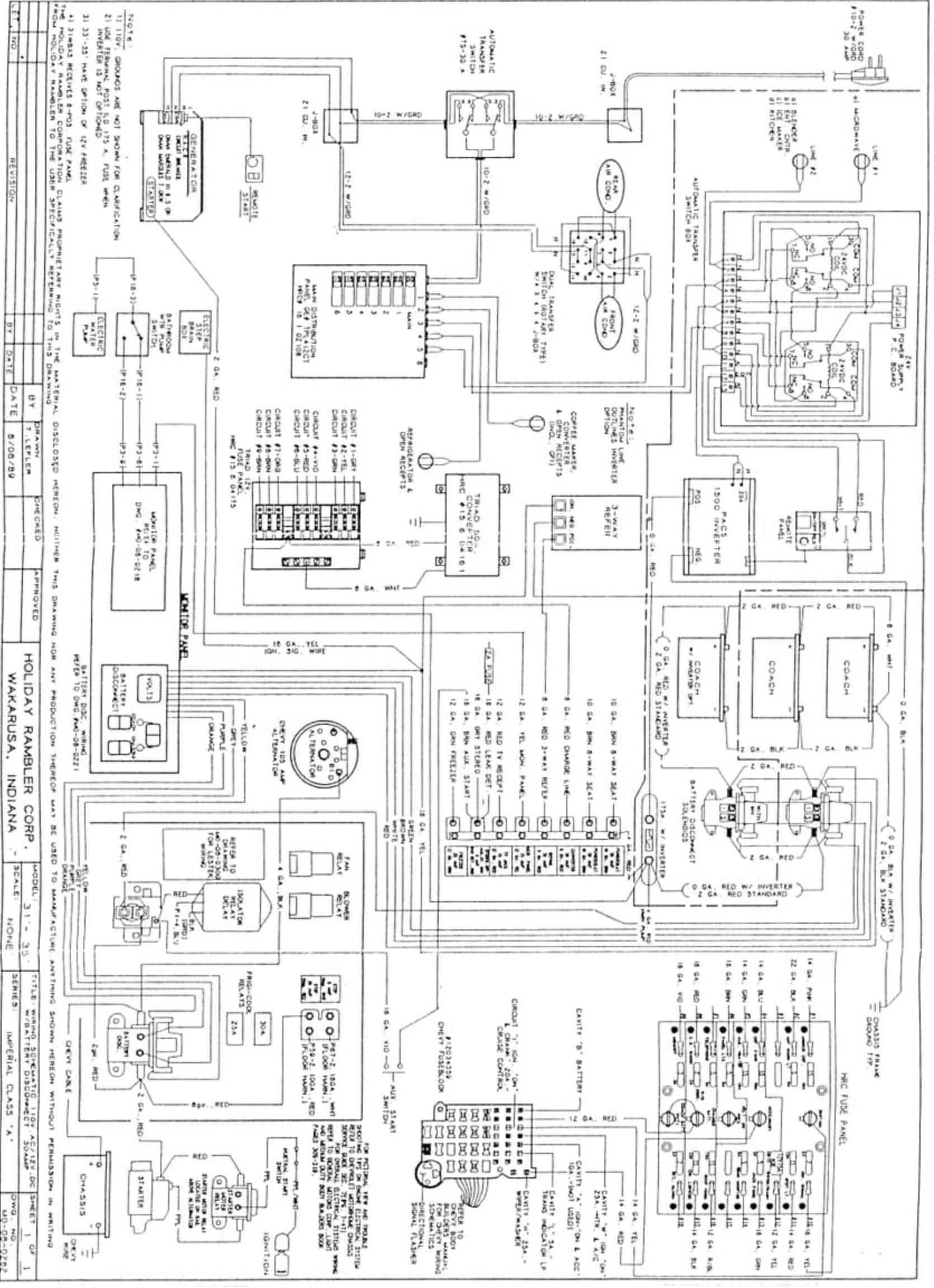

NOTE:
 1) 110V. GROUNDS ARE NOT SHOWN FOR CLARIFICATION
 2) USE TERMINAL POST NO. 175 A. FUSE WHEN INVERTER IS NOT OPERATED
 3) 23-23' HAVE OPTION OF 12V FUSELIER

1) 21MBIA RECEIVES 6-POS FUSE PANEL
 THE HOLIDAY RAMBLER CORPORATION CLAIMS PROPRIETARY RIGHTS IN THE MATERIAL DISCLOSED HEREIN. HOWEVER THIS DRAWING NOW ANY PRODUCTION THEREOF MAY BE USED TO MANUFACTURE ANYTHING SHOWN HEREIN WITHOUT PERMISSION IN WRITING FROM HOLIDAY RAMBLER TO THE USER SPECIFICALLY REFERENCING TO THIS DRAWING

REVISION NO. BY DATE
 REVISION NO. BY DATE
 REVISION NO. BY DATE

BY DATE
 DRAWN BY DATE
 CHECKED BY DATE
 APPROVED BY DATE

HOLIDAY RAMBLER CORP.
 WAKARUSA, INDIANA

MODEL: 31-35
 SCALE: NONE
 SERIES: IMPERIAL CLASS "A"

FILE: WIRING 30-EMATIC 110V AC/12V DC SHEET 1 OF 1
 DWG. NO. HO-05-0222

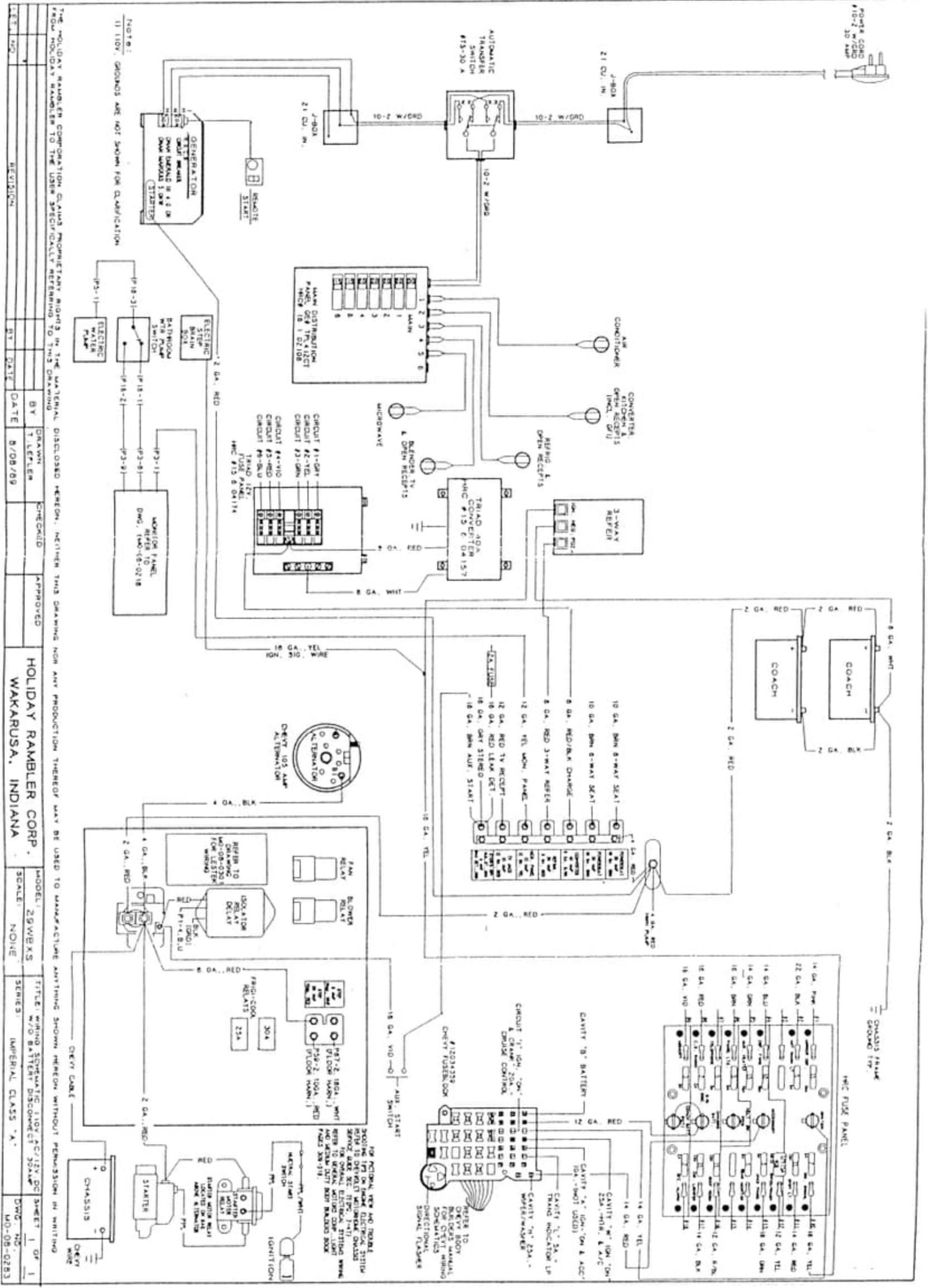

NOTE:
 1) 110V. GROUNDS ARE NOT SHOWN FOR CLARIFICATION

THE HOLIDAY RAMBLER CORPORATION CLAIMS PROPRIETARY RIGHTS IN THE MATERIAL DISCLOSED HEREON. NEITHER THIS DRAWING NOR ANY PRODUCTION THEREOF MAY BE USED TO MANUFACTURE ANYTHING SHOWN HEREON WITHOUT PERMISSION IN WRITING FROM HOLIDAY RAMBLER TO THE USER SPECIFICALLY REFERRING TO THIS DRAWING.

REV.	NO.	REVISION	BY	DATE	DRAWN	CHECKED	APPROVED	MODEL	SCALE	SHEET	TITLE	SERIES	DWG. NO.
1	1		T. LEBLER	8/08/89				HOLIDAY RAMBLER CORP.	29 WEXS	1 OF 1	WIRING SCHEMATIC 110V AC/12V DC SW-ET	IMPERIAL CLASS 'A'	MO-08-0283

HOLIDAY RAMBLER CORP.
WAKARUSA, INDIANA

FOR ORIGINAL USE AND REPAIR, SHOULD THE FUSE OR FUSE DISTRIBUTION BOX BE OVERHEATED WITH OVERCURRENT SERVICE, SEE SEC. 710V. 1-17. REFER TO OVERALL ELECTRICAL WIRING SCHEMATIC FOR FUSE BOX LOCATION AND WIRE GAUGE. REFER TO OVERALL ELECTRICAL WIRING SCHEMATIC FOR FUSE BOX LOCATION AND WIRE GAUGE.

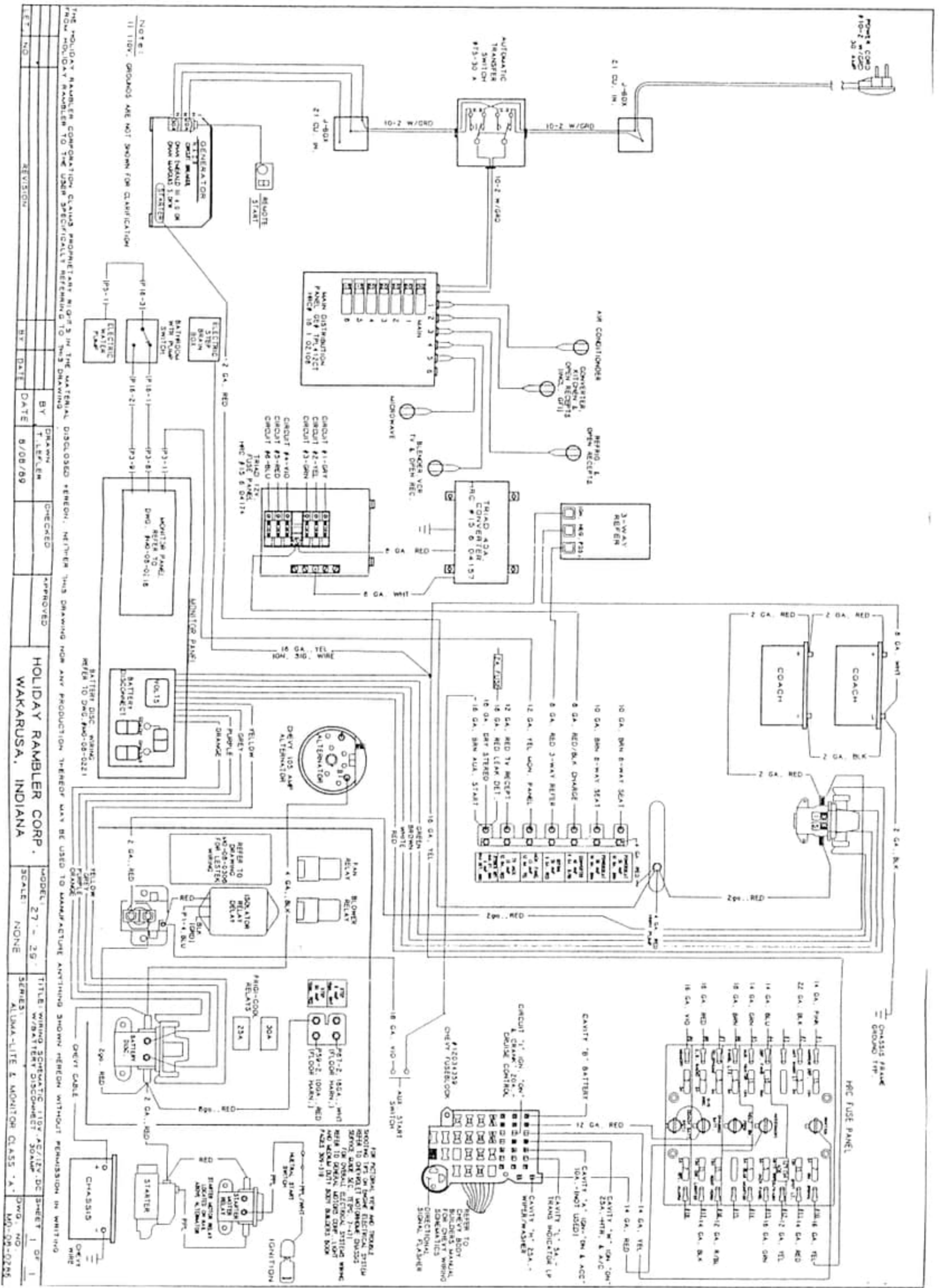

REV. NO.	REVISION	BY	DATE	DRAWN	CHECKED	APPROVED
1		T. LEBLEM	8/08/09			

HOLIDAY RAMBLER CORP.
 WAKARUSA, INDIANA
 MODEL: 27 - 29 -
 SCALE: NONE
 SERIES: ALUMA-LITE & MONITOR CLASS "A"
 DWG. NO. M0-08-0226

THE HOLIDAY RAMBLER CORPORATION CLAIMS PROPRIETARY RIGHTS IN THE MATERIAL DISCLOSED HEREON. NEITHER THIS DRAWING NOR ANY PRODUCTION THEREOF MAY BE USED TO MANUFACTURE ANYTHING WITHOUT PERMISSION IN WRITING FROM HOLIDAY RAMBLER TO THE USER SPECIFICALLY REFERENCING TO THIS DRAWING.

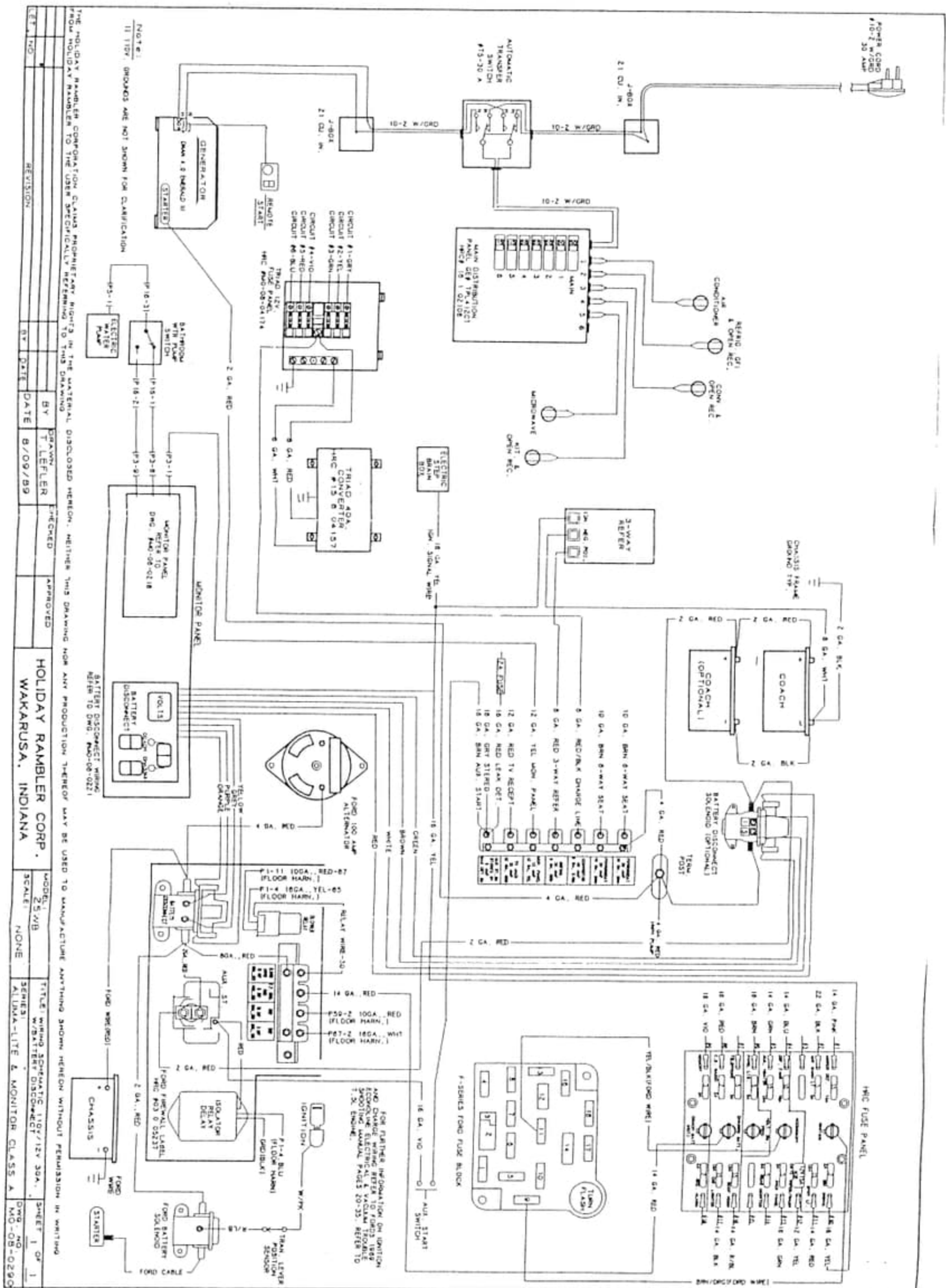

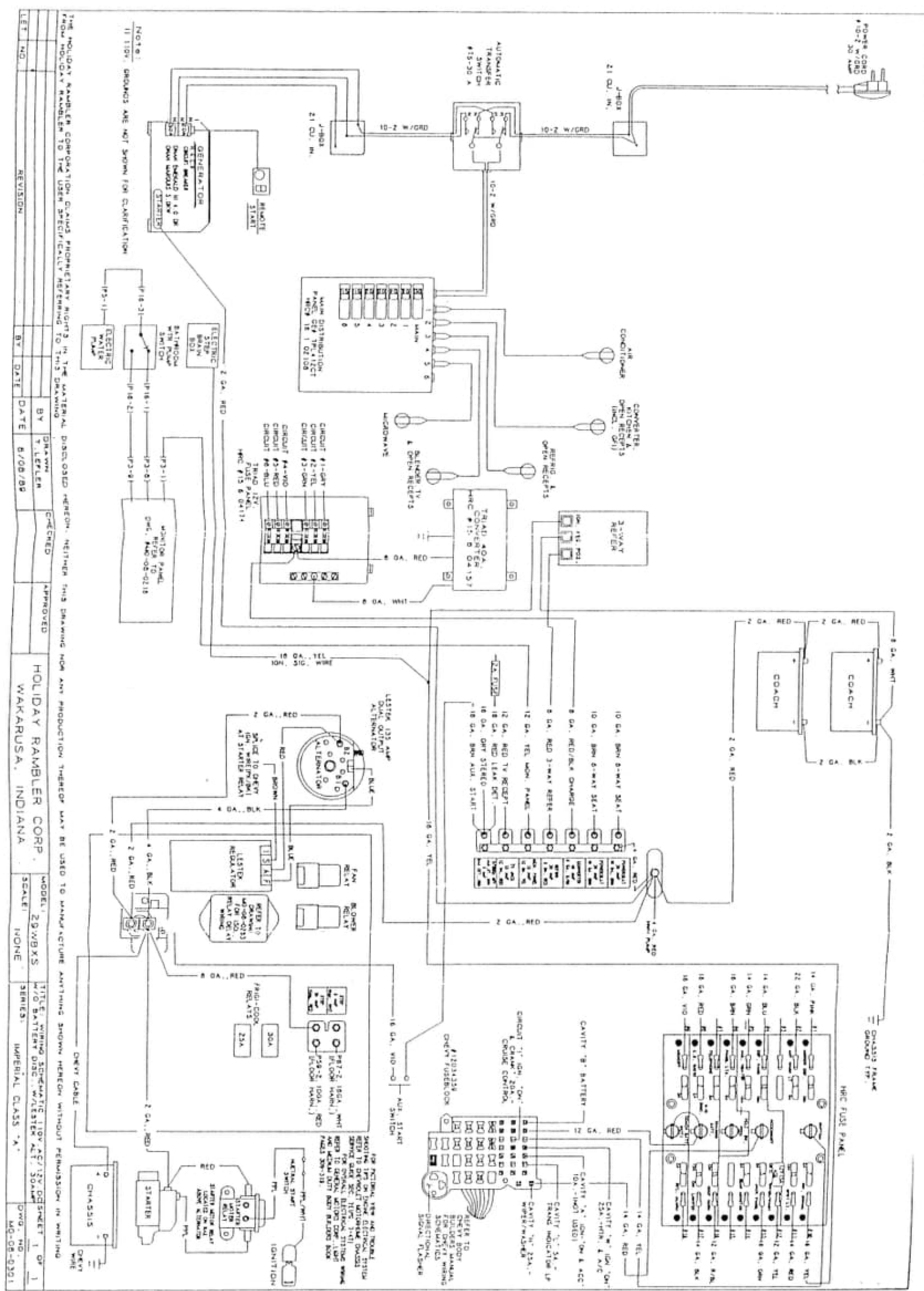

LET NO.	REVISION	BY	DATE	BY	DATE	BY	DATE	BY	DATE	BY	DATE

THE HOLIDAY RAMBLER CORPORATION CLAIMS PROPRIETARY RIGHTS IN THE MATERIAL DISCLOSED HEREON. NEITHER THIS DRAWING NOR ANY PRODUCTION THEREOF MAY BE USED TO MANUFACTURE ANYTHING SHOWN HEREON WITHOUT PERMISSION IN WRITING FROM HOLIDAY RAMBLER TO THE USER SPECIFICALLY REFERENCING TO THIS DRAWING.

HOLIDAY RAMBLER CORP. MODEL: 29WBXS TITLE: WIRING SCHEMATIC 110V AC/12V DC SHEET 1 OF 1
 WAKARUSA, INDIANA SCALE: NONE SERIES: IMPERIAL CLASS "A" DWG. NO. MQ-05-0301

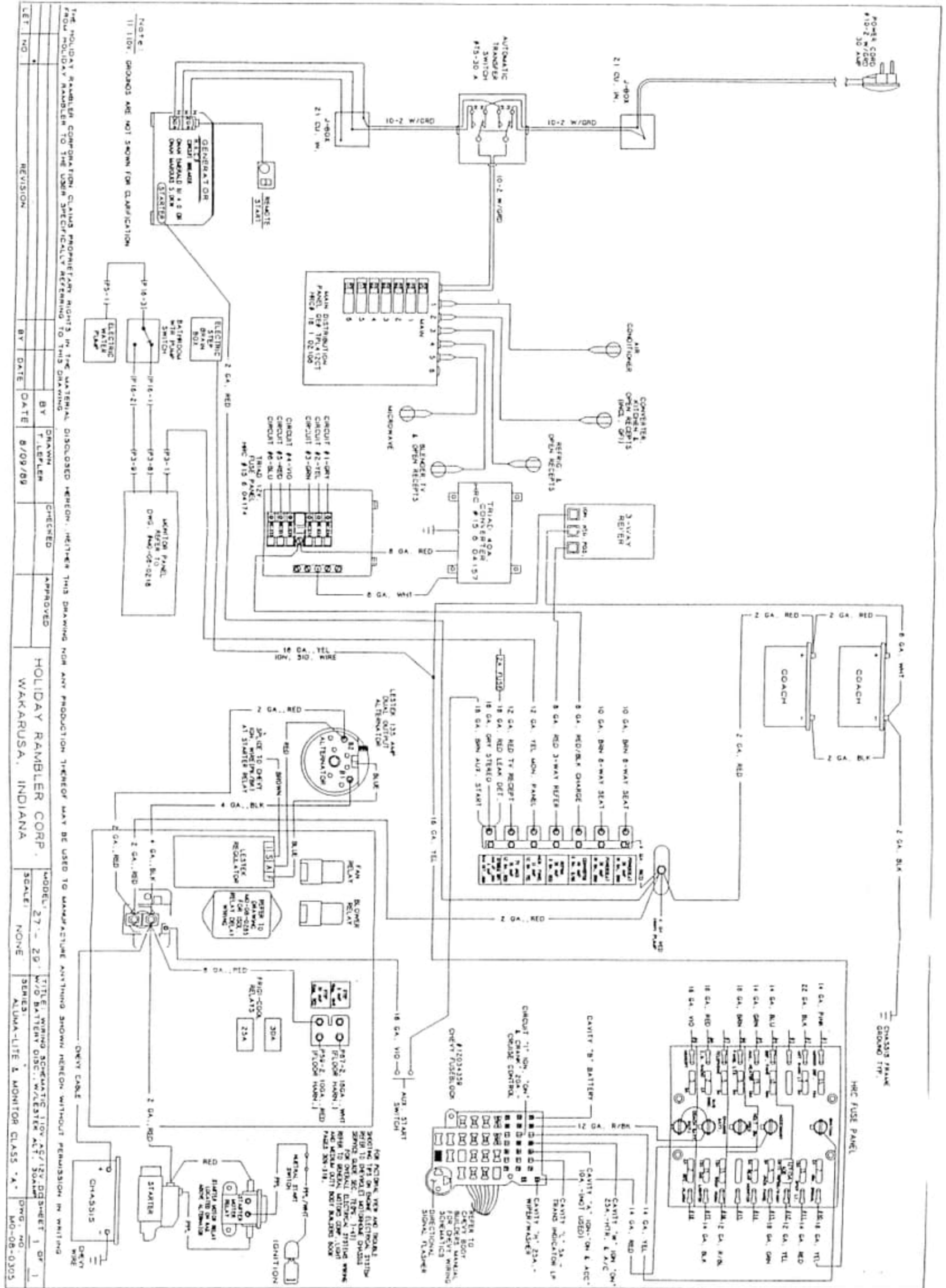

NOTE: 11.110V. GROUNDS ARE NOT SHOWN FOR CLARIFICATION.

THE HOLIDAY RAMBLER CORPORATION CLAIMS PROPRIETARY RIGHTS IN THE MATERIAL DISCLOSED HEREIN. NEITHER THIS DRAWING NOR ANY PRODUCTION THEREOF MAY BE USED TO MANUFACTURE ANYTHING SHOWN HEREON WITHOUT PERMISSION IN WRITING FROM HOLIDAY RAMBLER TO THE USER SPECIFICALLY REFERRING TO THIS DRAWING.

LET NO	REVISION	BY	DATE	BY	DATE	APPROVED

HOLIDAY RAMBLER CORP.
WAKARUSA, INDIANA

MODEL: 27-29
TITLE: WIRING SCHEMATIC 110V AC/12V DC SHEET 1 OF 1
SCALE: NONE
SERIES: ALUNA-LITE & MONITOR CLASS "A"
DWG. NO: MO-08-0303

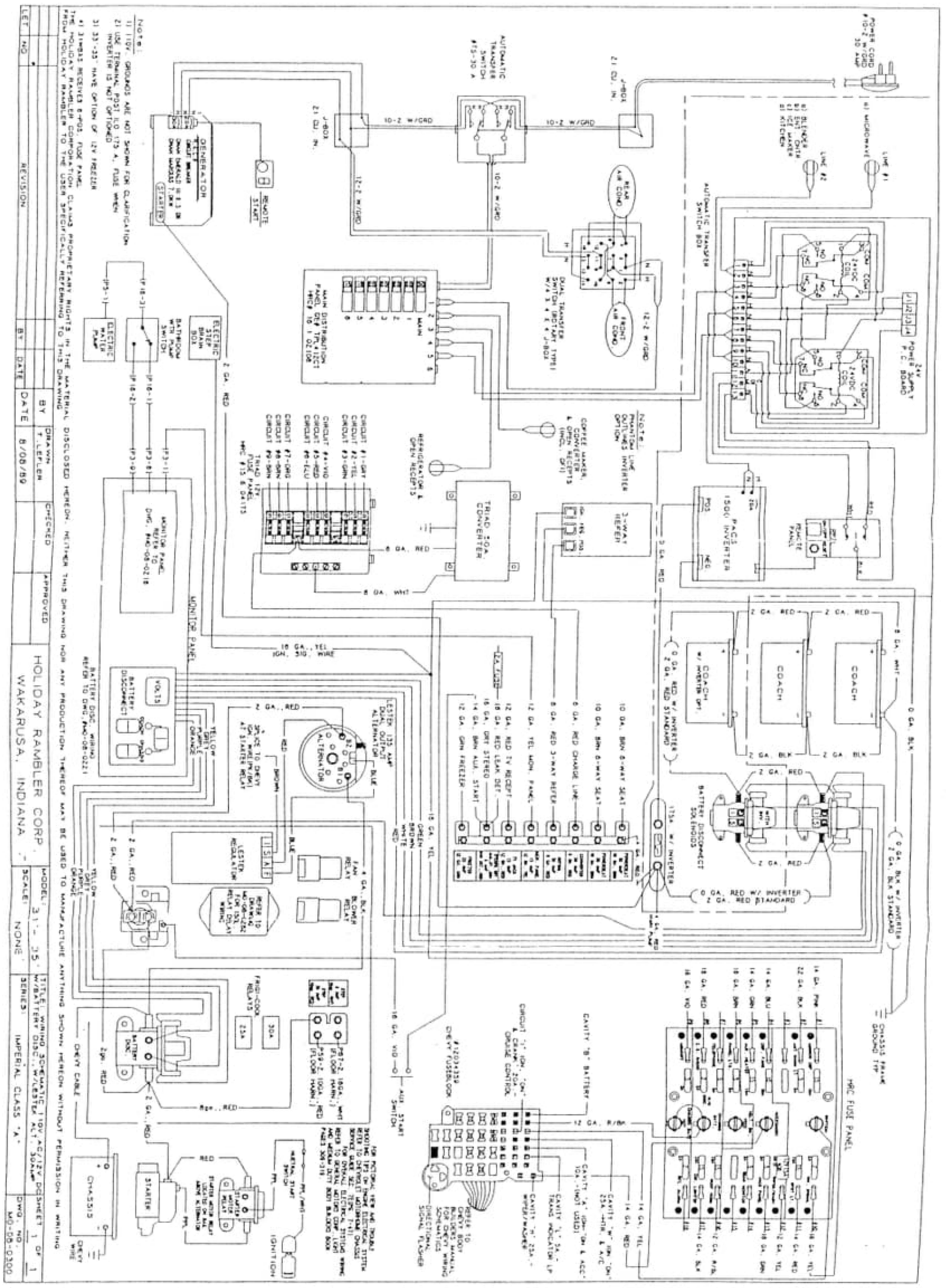

NOTE: 1) 110V GROUNDING ARE NOT SHOWN FOR CLARIFICATION
 2) USE TYPICAL POST TO 175 A. FUSE WHEN WIRE IS NOT SHOWN
 3) 23-25 HAVE OPTION OF 12V FUSE

4) 110V RECEIVES 8-POS. FUSE PANEL. CLAIMS PROPRIETARY RIGHTS IN THE MATERIAL DISCLOSED HEREON. WITHIN THIS DRAWING FOR ANY PRODUCTION THEREOF MAY BE USED TO MANUFACTURE ANYTHING SHOWN HEREON WITHOUT PERMISSION IN WRITING FROM HOLIDAY RAMBLER CORP. TO THE USER SPECIFICALLY REFERRED TO IN THIS DRAWING.

REV. NO.	REVISION	BY	DATE	CHECKED	APPROVED
1		F. L. FLEMING	8/20/89		

HOLIDAY RAMBLER CORP.
 WAKARUSA, INDIANA

MODEL: 311-35
 SCALE: NONE
 SERIES: IMPERIAL CLASS "A"

DATE: 8/20/89
 BY: F. L. FLEMING
 CHECKED: APPROVED

DRWG. NO.: MD-05-0300

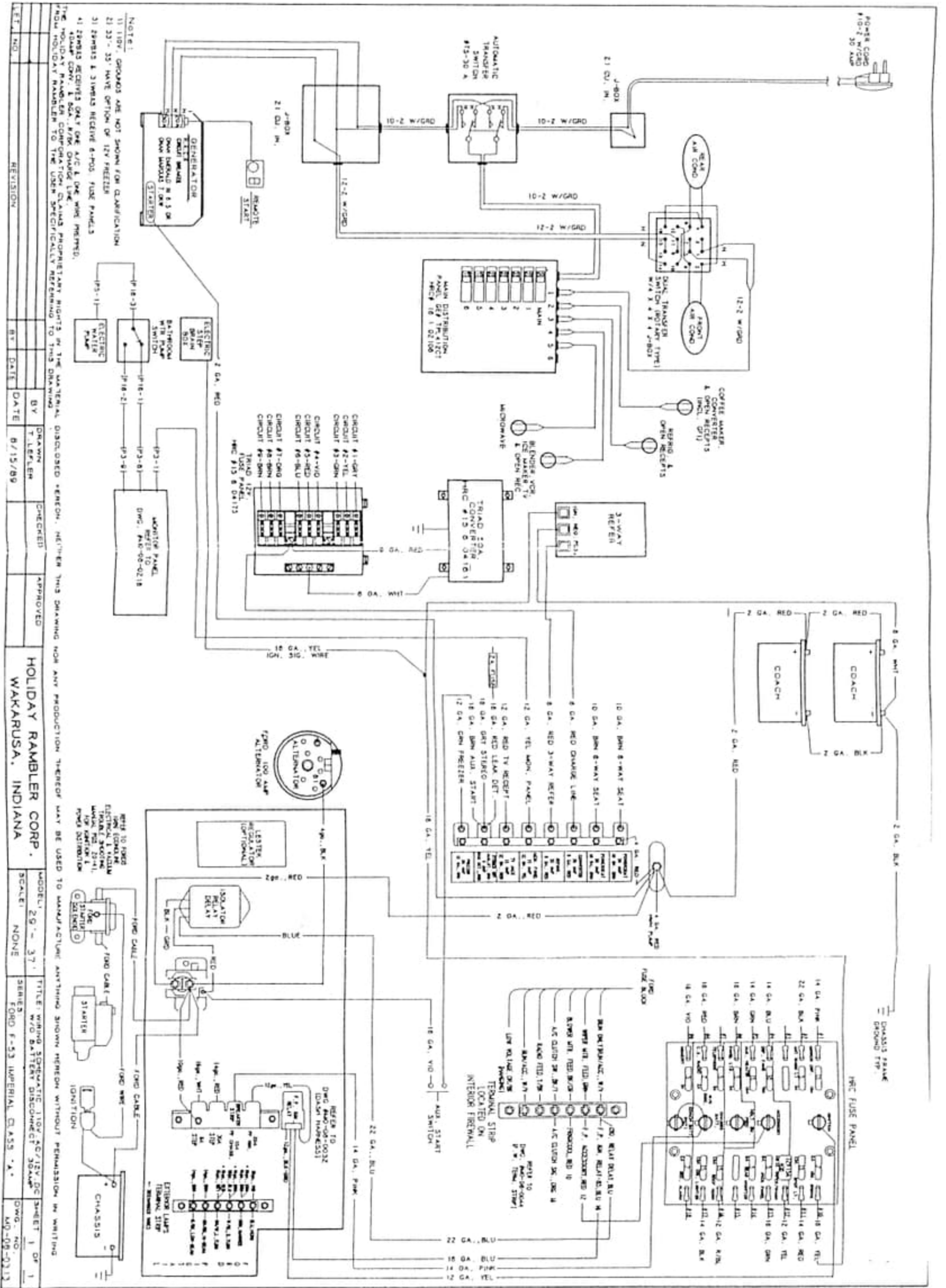

NOTE: 11 1/2V. GROUNDS ARE NOT SHOWN FOR CLARIFICATION
 21 23' - 25' HAVE OPTION OF 12V FREEZER
 31 SEATBELT & 31 SEATBELT RECEIVE 8-POS. FUSE PANELS
 41 SEATBELT RECEIVES ONLY ONE A/C & ONE WIRE PREHEAT
 THE HOLIDAY RAMBLER CORPORATION CLAIMS PROPRIETARY RIGHTS IN THE MATERIAL DISCLOSED HEREON. NEITHER THIS DRAWING NOR ANY PRODUCTION THEREOF MAY BE USED TO MANUFACTURE ANYTHING SHOWN HEREON WITHOUT PERMISSION IN WRITING FROM HOLIDAY RAMBLER TO THE USER SPECIFICALLY REFERRED TO IN THIS DRAWING.

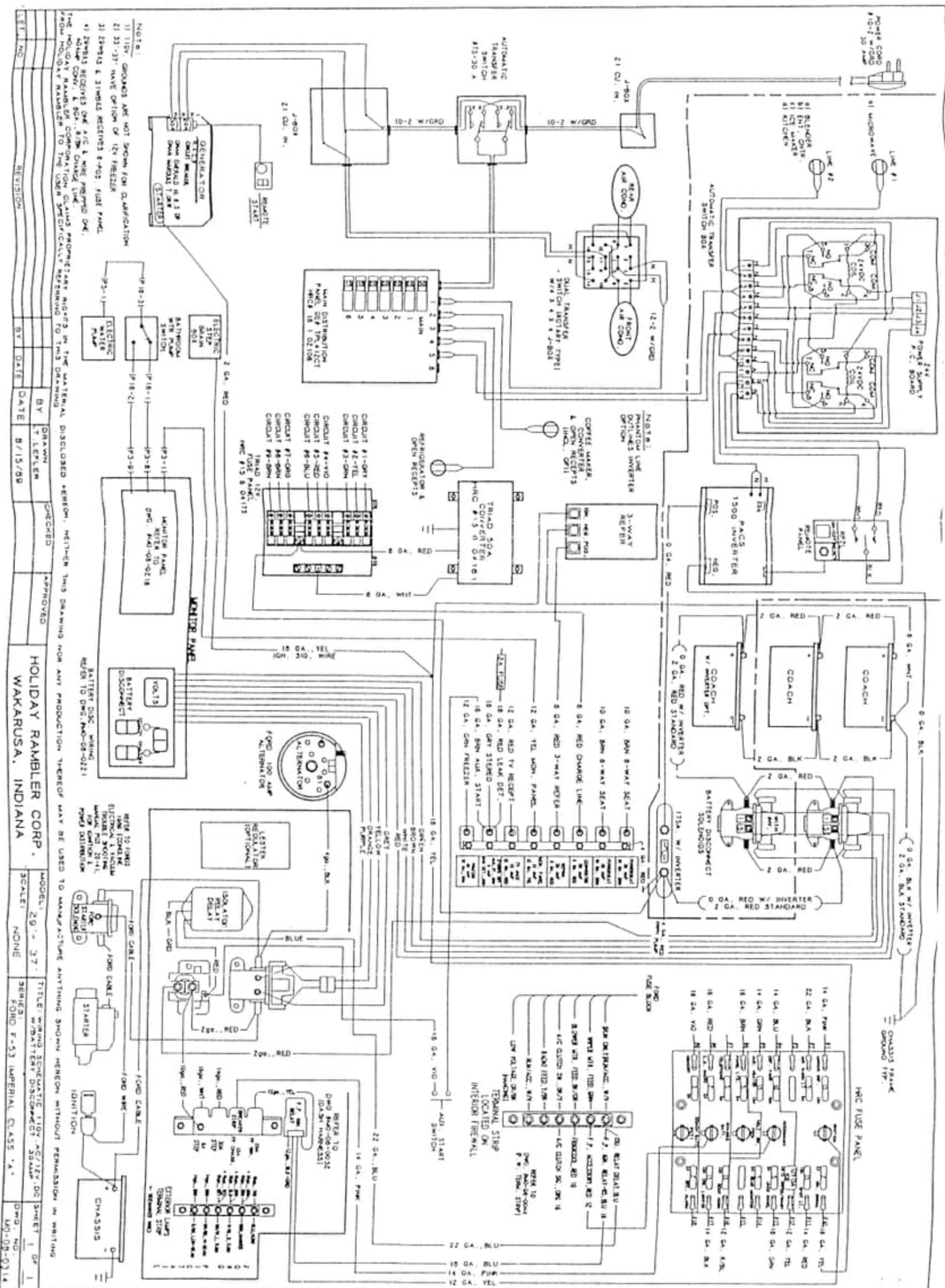

HOLIDAY RAMBLER CORP.
WAKARUSA, INDIANA

MODEL: 29-37
SCALE: NONE
SERIES: FORD F-53 IMPERIAL CLASS 'A'

DATE: 8/15/88
BY: T. LEBLER
CHECKED: APPROVED

FIG. NO. 100-0118

