

96

Four Winds **MOTORHOMES**

by
Four Winds International Corp.



Owner's Manual

701 COUNTY ROAD 15 • P.O. BOX 1486
ELKHART, IN 46515-1486

PLACE
STAMP
HERE

FOUR WINDS INTERNATIONAL
701 COUNTY ROAD 15 • P.O. BOX 1486
ELKHART, IN 46515-1486

**FOUR WINDS INTERNATIONAL CORP.
NEW RECREATIONAL VEHICLE LIMITED WARRANTY**

WARRANTY COVERAGE

Four Winds International Corp., warrants to the first retail purchaser from an authorized dealer that your **Four Winds International** product will be free from substantial defects in material and workmanship for a period of one year from the date of retail purchase or for the first 12,000 miles of usage, whichever comes first. **Four Winds International** will make repairs which are necessary because of defects in material or workmanship. We will repair or replace any defective part at no cost to you. As a result of product improvements, design changes, and unavailability of original brands, we may substitute parts or components with equivalent quality parts.

Commercial use of the motor home, use as a rental vehicle, or use as a permanent dwelling will void the warranty.

NON-COVERED ITEMS

Proper maintenance is the owner's responsibility and should be completed in line with manufacturer's guidelines.

Damage as the result of neglect, misuse, abuse, collision, alteration, improper maintenance and improper repairs.

Normal deterioration and wear of fabrics, carpets, counter surfaces and interior and exterior finishes.

Equipment that has been used for purposes that it was not designed.

Automotive chassis, including the engine, tires, batteries and optional automotive equipment as well as appliances, including range, oven, refrigerator, furnace, air conditioner and water heater, that are covered by separate manufacturer's warranties.

Any warranties stated by any person beyond those contained in this publication.

OWNER REGISTRATION CARD	
DATE OF PURCHASE _____ CHASSIS SERIAL NO. _____ CHASSIS MANUFACTURER _____ MILEAGE _____	FOUR WINDS SERIAL NO. _____ MODEL _____ YEAR _____
THIS PRODUCT WILL BE WARRANTED IN THE NAME OF:	
<u>OWNER</u>	
OWNERS NAME (LAST, FIRST, MIDDLE) _____ REGULAR MAILING ADDRESS - STREET OR P.O. BOX _____ CITY _____ STATE _____ ZIP _____ COUNTY _____ TELEPHONE (AREA CODE) _____	
<u>DEALER</u>	
SELLING DEALER _____ REGULAR MAILING ADDRESS - STREET OR P.O. BOX _____ CITY _____ STATE _____ ZIP _____ TELEPHONE (AREA CODE) _____	
OWNERS SIGNATURE (MUST BE SIGNED) _____	

MUST BE COMPLETED AND MAILED TO FOUR WINDS INTERNATIONAL WITHIN 10 DAYS OF PURCHASE

OWNER'S OBLIGATIONS

Four Winds International recommends that warranty service be performed by the authorized dealer from whom the purchase was made, however, when traveling, service can be performed by any authorized dealer.

The *Owner Registration Card*, needed to obtain any warranty service, should be carried in the vehicle at all times.

The original purchaser must return the *Owner Registration Card* within ten (10) days of purchase to validate the unit's warranty.

It is the owner's responsibility and expense to take the product to an authorized **Four Winds International** dealer or service facility for warranty repairs.

LIMITATION OF IMPLIED WARRANTIES

Implied warranties, including any warranty of merchantability or fitness for a particular purpose, are limited in duration to the term of this written warranty. Some states do not allow limitations on how long an implied warranty lasts, so the above limitation may not apply to you.

CONSEQUENTIAL AND INCIDENTAL DAMAGES

Four Winds International shall not be liable for any incidental or consequential damages, such as expenses for transportation, lodging, loss or damage to personal property, loss of use of owner's product, inconvenience, or loss of income. Some states do not allow the exclusion or limitation of incidental or consequential damages, so the above limitation or exclusion may not apply to you.

This Warranty gives you specific legal rights and you may also have other rights which vary from state to state.

Your satisfaction is our first concern. For further information or help, contact:

FOUR WINDS INTERNATIONAL CORP.
701 County Road 15 • P.O. Box 1486
Elkhart, IN 46515-1486
Telephone: 219/266-1111

TABLE OF CONTENTS

WARRANTY COVERAGE	1
INTRODUCTION	4
REPORTING SAFETY DEFECTS	6
TRAVEL PREPARATION	8
IDENTIFICATION AND SAFETY	10
Recreational Vehicle S/N, Decals & Data Plates	10
Manufacturer's Warranties	11
Safety Regulations for L.P. Gas Systems	12
Fire Safety	14
Fire Extinguisher	14
Carbon Monoxide Detector	16
Smoke Detector	17
Seat Belts	18
AUTOMOTIVE OPERATIONS AND PROCEDURES	19
General Information	19
New Vehicle Break In	19
Foot Service Brakes	19
Wheels and Tires	19
Changing A Tire	21
Wheel Nut Torques	21
Wheel and Tire Balancing	22
Front Suspension and Alignment	22
Power Plant and Drive Train	22
Engine Access	22
Engine Cooling System	22
Proper Loading and Weight Distribution	24
Computing Your Load and Load Distribution	24
Wide Body Motorhomes	24
Hills, Dales and Making the Grade	29
Trailer Towing	30
Emergency Stopping and Towing	31
Fuel Pump Collision Shutoff Switch	31
Fuel	31
Fuel Filling	31
Carbon Monoxide Safety Precautions	31
CHASSIS FUNCTIONS	34
Dash Controls (Class C and Class A)	34
Dash Switch Panel	35
Hydraulic Power Levelers	42

CHASSIS FUNCTIONS (Continued)	
Driver and Passenger Seats	43
Seat Belts	45
Rear Vision TV Monitor System	45
INTERIOR CONTROLS AND OPERATIONS	46
Living Quarters	46
Condensation	46
Windows	47
Doors, Drawers and Storage Compartments	47
Seating, Tables and Additional Beds	48
Overhead Vents	50
Weather Center and Clock	50
EXTERIOR OPERATIONS	51
Entry Door	51
Driver Side Door	51
Step	52
Power Step	52
Storage	53
Ladder and Roof Top Storage	53
LP GAS SYSTEM	54
General Information	54
Filling the LP Gas Tank	55
LP Gas Regulator	55
Regulator Freeze-Up	57
Hoses, Pipes, Tubes and Fittings	58
Checking the LP Gas System for Leaks	59
LP Gas Leak Detection System	59
LP Gas Safety Precautions	63
ELECTRICAL SYSTEM	64
General Information	64
Batteries	65
Battery Safety	67
Automotive 12 Volt System	67
Battery Isolator Controller (BIC)	67
Battery Isolator (Class C)	68
Power Converter	68
Battery Charging	69
Battery Disconnect Switch	70
Ground Fault Circuit Interrupter	70
Circuit Breakers	71
12 Volt Fuses	72
Generator	73

WATER AND DRAINAGE	70
General Information	70
Fresh Water System	70
Sanitizing the Fresh Water System	71
Monitor Panel	71
Waste Water System	81
Holding Tanks	81
Faucets	81
Toilet	81
Water System Winterization	81
Water System Maintenance and Troubleshooting	81
APPLIANCES	81
General Information	81
Refrigerator	81
Water Heater	81
Range	81
Range Hood	81
Microwave Oven	81
Roof Air Conditioner	81
Air Conditioner Selector Switches	91
Furnace	91
Audio and Video	91
TV Antenna	91
CARE AND MAINTENANCE	91
General Information	91
Care and Maintenance	91
Winter Precautions	101
Storage Preparation	101
Maintenance Chart	101

Product information included herein is as accurate as possible at the time of printing. Subsequent refinements may be evident in the actual product. Specifications are subject to change without notice. Some equipment mentioned in this manual may not be available or included on your motorhome.

INTRODUCTION

It's exciting taking ownership for a new purchase as substantial and full of nearly unlimited possibilities for the future as a motorhome.

Thank you for choosing a **Four Winds International** product.

We take your choice seriously. That's why we've engineered this vehicle to meet and, in many cases, exceed federal and state regulations and requirements for vehicles of this type. Our primary concern has been to provide our customers with a beautiful recreational vehicle that is not only dependable and cost effective, but also safe.

To keep this vehicle at peak performance and to obtain the maximum pleasure from its use over an extended period, the owner must take a personal interest in its care and operation. Therefore, before operating it, we suggest that you review the entire contents of this manual. The material within has been prepared in sufficient detail to be of considerable help when you are getting to know your new recreational vehicle.

That is the purpose of this Owner's Manual. It outlines the operation of the unit's various systems and offers many helpful hints that will enable you to obtain the most pleasure from this traveling home.

This manual is intended to explain the majority of the features of our Class A Motorhomes and Mini Motorhomes. Most of these are similar in nature, however; some features mentioned in this manual may not apply to your specific recreational vehicle.

Review both this manual and the chassis manufacturer's owner's manual with your dealer. Be sure to ask them any questions you have at that time. Also make sure to read all warranty and registration information carefully. Read all component manufacturer's owner's manuals, and validate any individual warranties by completing and mailing individual warranty cards as required.

Refer to the chassis owner's manual supplied by the chassis manufacturer for complete information on the care and maintenance of the chassis.

COMPLETE THE WARRANTY REGISTRATION CARD IN THIS MANUAL AND RETURN TO US WITHIN 10 DAYS FROM THE DATE OF PURCHASE.

Always keep this owner's manual with the recreational vehicle for easy reference, making sure to observe all notes and warnings associated with the use of the recreational vehicle. A careful owner is the best insurance against an accident.

THIS OWNER'S MANUAL IS AS CURRENT AS POSSIBLE AT THE TIME YOUR RECREATIONAL VEHICLE WAS PRODUCED. HOWEVER, SINCE OUR PRODUCTS ARE CONSISTENTLY BEING UPGRADED AND IMPROVED; SOME DIFFERENCES MAY OCCUR BETWEEN THE DESCRIPTION IN THIS MANUAL AND THE PRODUCT IN THE RECREATIONAL VEHICLE. IF THIS OCCURS, FOLLOW THE COMPONENT MANUFACTURER'S INSTRUCTIONS PROVIDED IN THEIR LITERATURE.

SOME OF THE PRODUCTS SHOWN IN THIS MANUAL MAY BE OPTIONAL EQUIPMENT NOT INCLUDED OR AVAILABLE WITH YOUR RECREATIONAL VEHICLE. ANY SPECIAL EQUIPMENT, MODIFICATIONS, OR ADDITIONS MADE BY OR AT THE REQUEST OF THE CUSTOMER, OR ANY SUBSEQUENT OWNER, WHETHER MADE AT THE FACTORY OR IN THE FIELD, ARE NOT COVERED IN THIS MANUAL. WE RESERVE THE RIGHT TO CHANGE THE CONSTRUCTION OR MATERIAL OF ANY PARTS AT ANY TIME WITHOUT INCURRING THE OBLIGATION TO INSTALL SUCH CHANGES ON DELIVERED UNITS.

Your recreational vehicle has had a thorough inspection before it was shipped to the dealer. However, to insure your complete satisfaction, the dealer must perform an inspection of various components and operations based on a pre-delivery inspection list provided. You should take the opportunity to cover the operation of all components of your recreational vehicle with your dealer. This will help make you familiar with the recreational vehicle and its operation, while at the same time providing you with the assurance of everything being in proper working order. A road test by the dealer should be included as part of the pre-delivery inspection. He can then check for and correct any steering problems before you take delivery of the recreational vehicle. After this road test has been completed, front end alignment and/or vibrations will not be covered as part of the new vehicle warranty.

This recreational vehicle has been designed for short term and recreational use. It was not designed to be used as a permanent dwelling or as a rental vehicle. If you intend to use your recreational vehicle as a permanent dwelling or rental vehicle, it could cause your carpet, drapes, upholstery, and interior surfaces to deteriorate prematurely. This premature wear caused by long term or permanent residency may, under the terms of the new vehicle warranty, be considered abnormal and abusive and **COULD REDUCE YOUR WARRANTY COVERAGE.**

Should a problem develop for which you need assistance, contact your dealer. If the problem is automotive, the motorhome should be taken to either a chassis manufacturer service center or dealer. If the problem is with an appliance, check the appliance manufacturer's information supplied with the recreational vehicle for information regarding warranty work and/or location of appliance service centers.

If, when traveling, you experience a breakdown or problem while your recreational vehicle is under warranty, and an authorized service center or dealer is not available, contact the dealer you purchased your recreational vehicle from before having the work done at an independent service center. By notifying them, you will know what is covered under the terms of your warranty, as well as making them aware of your problem. **Any parts that require replacement, that are covered under the terms of the warranty should be retained and returned to your local dealer along with your invoice.** This way, they are able to check what has occurred, and also make sure you are properly reimbursed for your expenditures.

Repairs made without prior authorization may be subject to denial or partial reimbursement. Modifications made to the recreational vehicle without proper authorization can result in reduction or loss of warranty coverage. Please make sure to contact your dealer before making such changes.

REPORTING SAFETY DEFECTS

The following note is added as a requirement of the National Highway Traffic Safety Administration (NHTSA):

If you believe that your vehicle has a defect which could cause a crash or could cause injury or death, you should immediately inform the National Highway Traffic Safety Administration (NHTSA) in addition to notifying the manufacturer.

If NHTSA receives similar complaints, it may open an investigation, and if it finds that a safety defect exists in a group of vehicles, it may order a recall and remedy campaign. However, NHTSA cannot become involved in individual problems between you, your dealer, or the manufacturer.

To contact NHTSA, you may either call the Auto Safety Hot-line toll-free at 1-800-424-9393 (or 366-0123 in Washington, D.C. 20590). You can also obtain other information about motor vehicle safety from the Hot-line.

FIRST SHORT TRIPS

After becoming familiar with the vehicle's systems and going through test runs on items such as use of Liquid Petroleum Gas (LPG), it is time to take one or two short trips, including spending the night at a campground not too distant from your home . . . you might want to go back and get something you forgot or didn't know you needed.

These short trips can be considered "shake down cruises" or "familiarization flights": The experience gained on these short trips will be worth the time and money to you . . . time and money spent either needlessly, taking something that takes up space or the time and money spent trying to obtain an item you hadn't counted on needing prior to leaving home base on an extended trip miles from home and in unfamiliar surroundings.

It is understandably upsetting having to purchase a needed item on the road knowing that one is sitting at home unused.

Not all RVers need the same equipment or supplies. For one thing, the United States presents a wide variety of climates and terrain. For another, personal needs and tastes come into play.

Our suggestion is to take a weekend trip to a camp location that is close to home. Be sure to have a note pad and pen available to write down items you feel will be needed in the future as well as equipment that you may need to learn more about.

Also, if most of your trips will be made in the summer and your shake down trip is made during some other season, there will be adjustments to take into consideration. Talk to other RVers and learn from their experiences.

If you are an experienced RVer it is still necessary to thoroughly read this manual. New and improved equipment is coming onto the market every day and, at the same time, not every motor home manufacturer builds vehicles the same way.

This manual is packed with detail, however, after you have worked with the various systems during a couple of shake down trips, you will be capable of conducting a pre-trip check in less time than it takes to read this manual.

Because of different RV models **Four Winds International** manufacturers and the numbers of options available, your RV may not include all of the systems described in this manual.

TRAVEL PREPARATION

Like any vacation trip, pre-planning will pay big dividends. A checklist is often helpful.

In addition to routine trip preparations such as having newspaper delivery stopped and mail held at the post office, there are now more vehicle-related preparations than there were with the old family car.

CHASSIS CHECKS

As with any vehicle, the RVer needs to check the automotive systems prior to a trip. They include:

Under Hood:

- Fluid Levels (oil, power steering, radiator, transmission, windshield washer, etc.)
- Belts (tension and condition)
- Battery (electrolyte level if applicable, connections, charge)
- Hoses (clamps tight, condition, leakage)
- Seals, Gaskets (leaks)

Exterior:

- Tire pressure/condition and lug nut torque
- Spare tire, rim condition, and tools-including jack
- Headlights, running and safety marker lights including brake and turn signal and also any trailer light connections
- Rear view mirror adjustment
- Security of any auxiliary equipment such as TV and CB antennae, awning, etc.
- Windshield wiper blade condition
- Generator compartment
- Fresh and waste water connections/drains and supplies such as high pressure hose
- Liquid Petroleum Gas compartment/tank

Under Vehicle:

- Drive train condition, specifically leaks (U-joints, differential, transmission)
- Brakes including lines, pads/shoes, seals
- Engine area for pan gasket or other leaks
- Anything unusual hanging or tangled with road debris such as tree limbs
- Tank condition (gas, fresh water, waste water)
- Wheel cylinder seals (leakage)

Inside Driver's Compartment:

- Check operation of all systems, including: Wipers; Windshield; Horn; Brakes; Emergency Brake; Steering Transmission; Heater; Defroster; Air Conditioner and Seat Adjustment
- Also idle engine long enough to check cooling system (temperature gauge/light) and Alternator (charging) operation. Be sure to turn on headlights and climate controls to see if alternator handles the additional drain on electrical system (should not show discharge).

RV System Check:

As an RVer you now have the added responsibility to prepare the living quarters for a trip.

Preparations include:

- Filling fresh water tank. In winter be sure that system is freeze protected
- Check list of food, utensil and clothing needs and to save weight and space do not take more than two or three days food supply.
- Check storage of all items, making sure that everything is secured and that heavy items are stored low so they do not fall.
- Check operation of stove and refrigerator.
- Check paper work such as Owner Registration Card, vehicle registration proof of insurance, driver's license and names/phone numbers of individuals you are to contact during the trip, such as Ranger Stations

 **WARNING:** Pay careful attention to where and what type of flammable materials you store. Certain storage areas are clearly labeled **DO NOT STORE COMBUSTIBLE MATERIALS**. Examples of spark-producing areas, depending upon RV model, are base kitchen cabinets, front dinette base, exterior refrigerator service compartment, as well as refrigerator cabinet. Please use your discretion as to what potentially dangerous products your RV contains while traveling. Be sure all canister and bottle tops are secure and leak-free

IDENTIFICATION & SAFETY

RECREATIONAL VEHICLE SERIAL NUMBER, DECALS, AND DATA PLATES

The recreational vehicle serial number label is mounted on the inside wall next to the driver's seat on a Class A Motorhome and on the inside of the driver's door post on a Mini Motorhome. Refer to the chassis owner's manual for the location of the chassis vehicle identification number on all motorized recreational vehicles.

IMPORTANT: Always give model, year, and the V.I.N. number information when ordering parts. Also, we recommend that you keep a copy of this information separate from the recreational vehicle in the event theft or vandalism requires you to supply a copy to the authorities.

Decals and data plates used throughout the recreational vehicle aid in its safe and efficient operation; others give service instructions. Read all decals, data, and instruction plates before operating your recreational vehicle.

When any decal, data, or instruction plate is damaged, painted over, removed, etc.; it should be replaced.

RECREATIONAL VEHICLE SERIAL NUMBER LABEL

MANUFACTURED BY:		DATE		
REG. VEH. MFD. BY:		DATE		
THIS VEHICLE CONFORMS TO ALL APPLICABLE FEDERAL MOTOR VEHICLE SAFETY STANDARDS IN EFFECT IN: DATE GYWR	FRONT	INTERMEDIATE	REAR	GAWR
				TIRES
				RIMS
				PSI COLD SINGLE
				PSI COLD DUAL
VEHICLE I.D. NUMBER		MODEL NUMBER		
TYPE: MULTIPURPOSE PASSENGER VEHICLE		CD-122		

MANUFACTURER'S WARRANTIES

The following list of components has been compiled to help you know which products on your recreational vehicle may have their own warranties. If you have any of these components on your recreational vehicle, be sure to check the literature supplied by the manufacturer to see if they require that you register your purchase with them to validate their warranty. We recommend that you send the various warranty registration cards immediately before any time constraints on registration expire. Manufacturer's literature is contained in a separate packet furnished with the owner's manual on newly delivered units. Only those products and options which are on your recreational vehicle will be included in this packet. You should go over this literature with your dealer during the pre-delivery inspection. Any shortages of literature should be reported to the dealer at that time.

APPLIANCES

Air Conditioner — Roof	Water Heater
Furnace	Television
Range	VCR/VCP
Range Hood	Radio
Microwave Oven	Ice Maker
Refrigerator	Coffeemaker

ELECTRICAL

110/12V Converter	LP Leak Detector
Generator	Battery
GFCI Receptacle	Smoke Detector
Carbon Monoxide Detector	

WATER & DRAINAGE

Toilet	Water Faucets
Water Pump	

LP GAS

Regulator	Gas Leak Detector
Gas Tank	

CHASSIS

Air Conditioner	Back Up Monitor
Cruise Control	Leveling Jacks
	Batteries

SAFETY

SAFETY REGULATIONS FOR LP GAS SYSTEMS AND APPLIANCES

The following warnings are posted throughout your recreational vehicle to provide information on LP gas safety. They have been installed not only because of the requirement to do so, but also as a constant reminder to occupants of the recreational vehicle to exercise proper caution when using or being around LP gas appliances and equipment. We are listing them here so that you may study them and make sure that you and your family understand and follow them.

 **The safety alert symbol is used throughout this manual to call attention to warnings where vehicle damage or possible personal injury may be involved.**

 **WARNING: It is not safe to use cooking appliances for comfort heating.**

COOKING APPLIANCES NEED FRESH AIR FOR SAFE OPERATION. BEFORE OPERATION:

1. OPEN OVERHEAD VENT OR TURN ON EXHAUST FAN. AND:
2. OPEN WINDOW.

This warning label has been located in the cooking area to remind you to provide an adequate supply of fresh air for combustion. Unlike homes, the amount of oxygen supply is limited due to the size of the recreational vehicle, and proper ventilation when using the cooking appliance(s) will avoid dangers of asphyxiation. It is especially important that cooking appliances not be used for comfort heating as **THE DANGER OF ASPHYXIATION IS GREATER WHEN THE APPLIANCE IS USED FOR LONG PERIODS OF TIME.**

Overfilling the LP gas container can result in uncontrolled gas flow which can cause fire or explosion. A properly filled container will contain approximately 80 percent of its volume as liquid LP gas. An 80 percent automatic shut-off has been installed on the LP gas tank which will automatically prevent further filling when the gas volume has reached 80 percent of tank capacity.

 **CAUTION: This tank is equipped with an automatic valve designed to close at 80% liquid full. Always open 20% fixed liquid level bleeder gauge while filling. Stop filling if liquid appears before valve shuts off.**

 **WARNING: All LP gas is contained under pressure. Due to the dangerous potential of any compressed gas, it is mandatory that the following requirements for the use of this tank be followed: tanks are to be installed, fueled and maintained in accordance with State and local codes, rules, regulations or laws and in accordance with the NFPA Pamphlet 58, Division IV.**

IF YOU SMELL GAS

- Extinguish any open flames, pilot lights, and all smoking materials.
- DO NOT touch electrical switches.
- Shut off the gas supply at the tank valve(s) or gas supply connection.
- Open doors and other ventilating openings. (DO NOT USE THE RANGE HOOD)
- Leave the area until the odor clears.
- Have the system checked and leakage source corrected before using again.

LP gas regulators must always be installed with the diaphragm vent facing downward. Regulators that are not in compartments have been equipped with a protective cover. Make sure that regulator vent faces downward and the cover is kept in place to minimize vent blockage which could result in excessive gas pressure causing fire or explosion.

 **WARNING: Portable fuel burning equipment including wood or charcoal burning grills and stoves shall not be used inside the vehicle because they may cause fire or asphyxiation.**

**Please
Don't
Drink
and Drive!**



FIRE SAFETY

Fire safety is an important part of owning a recreational vehicle. The following basic rules of fire prevention can help eliminate the possibility of a fire.

Make sure that everyone in your recreational vehicle is familiar with the location of exits, including emergency exit windows should an emergency arise.

1. Never store flammable liquids in the recreational vehicle.
2. Never leave cooking food unattended.
3. Never smoke in bed, and always use an ashtray.
4. Never allow children to play with LP gas or electrical equipment.
5. Never use an open flame as a flashlight.
6. Always repair faulty or damaged wiring and electrical components.
7. Never overload electrical circuits.
8. Locate and repair LP leaks immediately.
9. Keep cooking surfaces clean.
10. Don't allow rubbish accumulation.
11. Never clean with a flammable liquid.
12. Spray fabrics annually with a flame retardant.

If a fire does start, make sure to follow basic rules of safety:

1. Have everyone evacuate the recreational vehicle as quickly as possible.
2. After everyone is clear, check the fire to see if you can attempt to put it out. If it is large, or the fire is fuel-fed, get clear of the recreational vehicle and have the fire department handle the emergency.
3. **DO NOT** attempt to use water to put out the fire. Water can spread some types of fire, and electrocution is possible with an electrical fire.

If you determine that you can attempt to control the fire using the fire extinguisher, make sure you know how to use it. Read the label on the fire extinguisher, and study the information in this manual to become familiar with the safe operation and maintenance of the extinguisher.

FIRE EXTINGUISHER

Underwriter Laboratories classify fires into three types:

- Class A — Fires in wood, paper, fabric, rubber, and certain plastics.
Class B — Flammable liquids such as grease, cooking oils, gasoline, or kerosene.
Class C — Electrical fires started from live electrical wires, from short circuited motors or switches.

The fire extinguisher provided with the recreational vehicle is a chemical type suitable for extinguishing small fires of the class B or C type. Extinguishers are designed to put out a fire in the initial stage, not when it is blazing out of control. If a fire cannot be approached within 10', it is too late to do any good.

To fight a fire with an extinguisher, first remove the tamper-tape which covers the discharge push button. The extinguisher does not need shaking. Hold it upright and stand six to ten feet from the fire with a clear path to an exit. Press the button down all the way, aimed at the base of the fire and spray with quick motions from side to side.

Avoid inhaling the dry chemicals. Although non-toxic, they could cause temporary irritation and vomiting. When the fire is out, clean up the area as soon as possible. The dry chemicals are non-corrosive, but some residue may cause surface damage if left too long.

In the case of an electrical fire, disconnect the battery and throw off the main circuit in the unit. It is important that everyone knows where to find the main circuit and how it operates. If the shoreline power cord is connected, disconnect it.

To keep a fire extinguisher in operating condition:

1. **Check pressure** — monthly or more often. Check the nozzle for obstruction. Press the green pin below the nozzle. If it returns and sticks out from the extinguisher, it is operable. If the pin does not come back, discard extinguisher. Refillable models have a pressure gauge to check.
2. **Tamper tape** — Check the tape to make sure it is intact. **DO NOT** test the extinguisher. Even a partial discharge may cause leakage and make it useless when needed.
3. **Inspection tag** — When checking the extinguisher for pressure, enter the date checked on the inspection tag furnished with the recreational vehicle. Regular inspections will help insure the condition.

CARBON MONOXIDE DETECTOR (LECO C.C.I. Model 3350)

OPERATING YOUR DETECTOR

See the instruction sheet which came with your detector for complete information. Operating your CO Detector is easy. Once power is supplied, the detector will run through a warm-up and self-check cycle for ten minutes before beginning to monitor for CO gas. There are no switches to allow the unit to be accidentally turned off, so the LECO will provide reliable protection (providing that the test procedure is performed) by alerting you to the buildup of potentially dangerous levels of CO gas on a continuous basis.

TESTING THE DETECTOR

Carbon monoxide is a very dangerous gas, it is not wise to use deadly CO to test the operation of the detector. A commonly available source of gas is a butane lighter. Butane is combustible, *but not deadly*. Normally this detector ignores combustible gases. The TEST button will change the sensitivity so butane can be detected temporarily. If the detector will respond to butane, it will respond to CO gas during normal operation. This test will prove that your LECO CO detector is fully operational and that the sensor will detect a gas.

TESTING PROCEDURE

This test must be performed quickly. Be sure that you read and are familiar with this test procedure before beginning.

1. Be sure that the detector has been powered for a minimum of 10 minutes before testing.
2. Press and hold test button for approximately 10 seconds.
3. Without releasing the test button, aim the nozzle of a butane lighter towards the gas sensor area. (Shown in the circle above.)
4. Press the gas release quickly (not more than 1 second). **DO NOT ROTATE FLINT WHEEL.**
5. Release the test button.
6. The alarm should sound. If it does not, repeat this test then see the troubleshooting section in the instruction that came with your unit.
7. Wait 1 minute.
8. Press and release the test button to silence the alarm. If the alarm continues to sound, wait 30 seconds and press and release the test button again. **NOTE:** The alarm will reset within 5 minutes without pressing the test button.

HOW OFTEN TO TEST

You *must* test this detector at least once per week during use. If used in a vehicle or coach, it *must* also be tested after storage and before each trip.



WARNING: Carbon Monoxide cannot be seen or smelled and can kill you. If alarm sounds: Turn off appliances, vehicle or other sources of combustion at once (furnace, water heater, wood burning stove, RV, automobile, etc.) and call the Fire Department. Get fresh air into premises or vehicle. Have the problem corrected before restarting appliances or vehicle.

SMOKE DETECTOR

An ionization detector offers a broad range of fire sensing capabilities. However, they do possess limitations. Fire could start in a location that would prevent smoke from reaching the detector. They are also better at detecting fast flaming fires than the slow smoldering variety. They are also not a cure for poor fire safety habits. Smoke detectors need occasional maintenance for reliable service. A smoke detector is designed to be relatively maintenance free, but there are three things you can do to keep a detector in reliable working order:

1. **TEST IT** — at least once a week by firmly pressing the button located near the center of the cover. The alarm should sound briefly. If it does not work, replace the battery and test again.
2. **CLEAN** — the detector if grease or dust accumulates. The following procedure should be followed once a year.
 - a. Remove the cover and the battery.
 - b. Clean dust from sensing chamber openings with a vacuum and soft brush attachment.
 - c. Replace the battery and depress the test switch. The alarm should sound briefly. If it does not work, try a new battery.
3. **SERVICE** — the detector if it does not work by sending it to the manufacturer or their repair center. **DO NOT** attempt to make the repairs yourself (other than battery replacement).

NOTE: When the battery is low, the detector will make a "chirping" noise for seven days to remind you to change it.

SEAT BELTS

Seat belts are a very important safety feature in your motorhome. Anyone riding in the motorhome should wear a seat belt at all times while the motorhome is in motion. Children should be properly restrained rather than being held by an adult.

To fasten seat belts, insert the tongue into the buckle until you hear a snap and feel the latch engage. Adjust the belt to the proper position; snug and as low as possible around the hips, not around the waist. To unfasten the seat belts, push the release button in the buckle and allow the belt to unlatch.

Never have more than one person use an individual seat belt. Also, it is not possible to belt persons who are lying in a bed.

⚠ WARNING: All motorhome occupants should wear their seat belts for maximum protection in the event of a collision. For young children, infant and child restraints should be obtained and used in accordance with the instructions provided for, by the manufacturer of the restraint. In some areas, seat belt and/or child restraint use is required by law.

⚠ WARNING: In addition to the seat belt operating instructions given here, it is extremely important that you also review and follow all the instructions for seat belt and child restraints in the chassis owner's manual provided with your vehicle.

⚠ WARNING: Failure to adjust the seat belt properly could increase the chance of injury in the event of a collision.



AUTOMOTIVE OPERATIONS AND PROCEDURES

GENERAL INFORMATION

The chassis is the foundation and heart of your motorhome. With proper care and maintenance, it will provide years of service, and many miles of enjoyable travel.

You as owner, are the key to keeping your vehicle in good operating condition, as well as being responsible for taking the proper precautions when attempting any maintenance or repair activities. If you are not sure what action to take, or uncomfortable with performing a maintenance or repair function, contact your dealer, or a designated chassis manufacturer servicing dealer (check information supplied by chassis manufacturer for a servicing dealer near you).

Make sure to read all chassis information supplied by the chassis manufacturer, paying particular attention to precautionary notes and warnings, as well as all maintenance procedures and schedules.

NEW VEHICLE BREAK IN

Special procedures or schedules for breaking in your new motorhome are minimal. Make sure to follow the recommendations as outlined in the chassis owner's manual to insure proper future performance and economy.

FOOT SERVICE BRAKES

Operation and maintenance of the brake system is covered in the chassis owner's manual. Always be sure to keep your brakes in proper working condition, following the service schedule in the chassis literature, and the recommendations of your chassis service representative.

WHEELS AND TIRES

Your motorhome tires play an important role in the load carrying capacity of the vehicle. To insure good tire life, check tires often. Inspect the general condition of the tires, as well as the air pressure.

Always check the air pressure when the tire is cold. Tires that are hot from traveling will show higher pressures. The maximum tire pressure and the load carrying capacity of the tire is imprinted on each tire sidewall, as well as on the vehicle serial number I.D. tag. Always inflate your tires to their correct pressure. Do not over or under inflate. Under-inflated tires will run hot, shorten the tire's life, and decrease the motorhome's safe load limit. Over-inflated tires will cause a rough and bouncing ride that can damage motorhome components or cargo. It is a good idea to always carry an accurate tire pressure gauge in the motorhome to make these checks. If pressure checks indicate a tire is losing air, check for signs of valve leakage, penetration, or wheel and rim damage.

The way you drive can have a significant effect on the wear and life of tires also. High speeds, unusual use of the brakes, taking corners too quickly, quick starts, and surfaces in poor condition all can contribute to the early wear and failure of your tires. When you drive on surfaces with holes or rocks and other loose objects that can damage tires and cause misalignment, make sure to reduce speed and drive carefully.

If you notice damage to a tire such as a bulge, uneven wear, or damage by a foreign object or the road, have it inspected and repaired or replaced as needed. Remember that tires should be taken to an authorized tire repair facility.

On dual wheels, the outer tire receives additional wear while turning, due to the dragging and skidding effect that is produced by the difference in the turning radius between inner and outer tires.

NOTE: Cold tire inflation pressure is defined as a tire that has not been used for three or more hours, or has been driven less than one mile. Tire inflation pressure of a hot tire may show an increase of as much as 6 psi over a cold tire. Never bleed air out of a warm tire.

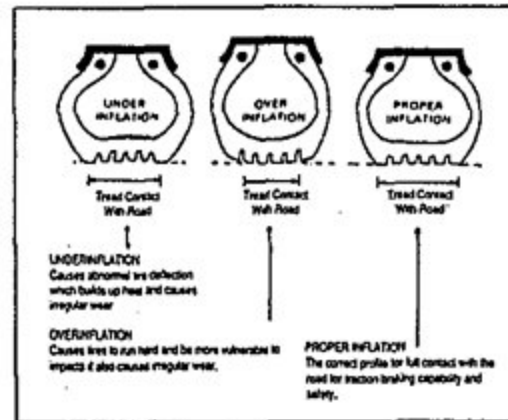

Tire Inflation

CHANGING A TIRE

If you experience a flat tire on your recreational vehicle, it is recommended that you have qualified personnel with the proper equipment handle the problem. Changing tires on large vehicles such as motorhomes requires special tools and knowledge that most people do not possess. Physical limitations are also a factor in the ability of an individual to change a flat tire. Because of the size and weight of recreational vehicle wheel and tire assemblies, as well as the amount of torque needed to tighten wheel nuts securely, it is best to call in a professional. It is for this reason a jack has not been included with the motorhome. Make sure that the wheel nuts have been tightened to the proper torques as outlined in the chassis manufacturer's owner's manual.



CAUTION: When replacing a tire, make sure to replace it with a tire of the same size and specifications.

WHEEL NUT TORQUES

It is also important to have the wheel nuts checked regularly to make sure they have not loosened during travel. Follow the schedule for regular wheel nut torque checks as outlined in the chassis manufacturer's owner's manual. If you suspect that wheel nuts have loosened at any time, have them checked and torqued to proper limits immediately.

If you suspect or notice wheel stud bolts are cracked or broken, they must be replaced, along with adjacent bolts that have probably also been weakened due to additional stress placed on them.

You, as the owner of the motorhome need to make frequent inspections of wheels and tires, looking for signs of wear or damage. You also need to avoid abusive driving habits, such as hitting curbs or chuck holes at high speed which can damage tires and wheel components.

NOTE: The proper method of tightening wheel nuts is with a torque wrench, not with an impact wrench or by hand. Because of the importance of having proper torque on wheel nuts, you should have wheels mounted and properly torqued by authorized personnel with the proper tools.



WARNING: Failure to retighten wheel nuts as required could allow wheels to come off while the vehicle is in motion, causing loss of control and possible collision.

WHEEL AND TIRE BALANCING

Handling and tire wear can be enhanced by maintaining the proper balance of wheel and tire assemblies. It is important to have wheel and tire balancing checked on a regular basis. If you experience handling problems or abnormal tire wear, it may be easily corrected by proper balance. Specialized equipment is required to effect proper balancing, and the motorhome should be taken to a shop that is qualified to perform this service.

FRONT SUSPENSION AND ALIGNMENT

Maintaining proper alignment will result in increased steering ease and stability of the motorhome. Because of this, tires and suspension will last longer and fuel economy will be increased. Many times, problems with tires can be traced back to poor maintenance which will cause mechanical failures in the motorhome. This is why it is important to follow a regular scheduled maintenance plan that can identify and correct mechanical problems before they cause greater and increasingly more expensive mechanical failures. Safety is also always enhanced by a properly maintained vehicle.

The term alignment refers to both the adjustment angles on the steering axle and suspension and the tracking of the rear axle. Many factors are considered when establishing proper alignment. Steering components, suspension, wheel bearings, and even proper loading all effect alignment.

Any time you notice unusual tire wear or experience poor handling of the motorhome, it would be wise to suspect improper alignment along with the various other possibilities that might be causing the problem (check the chassis owner's manual). Always have the alignment of the motorhome checked and adjusted by a qualified shop with the proper equipment to handle heavy vehicles.

POWER PLANT AND DRIVE TRAIN

Full operating and service information may be obtained by consulting the engine and drive train operating and service manuals provided by the chassis manufacturer. For maximum engine efficiency and long service life, always follow recommendations, as outlined by the chassis manufacturer. Regular visual inspections can help detect minor adjustments and needed maintenance. All other components of chassis should be inspected regularly per schedules set by chassis manufacturer.

Procedures for normal fuel stop service functions such as checking engine oil, coolant level, and drive belt condition are covered in the chassis owner's manual. Make sure to follow all schedules and procedures for regular routine maintenance as outlined.

ENGINE ACCESS

The motorhome engine can be accessed for service from inside the motorhome. The engine cover between the driver and passenger seats can be removed.

When reinstalling engine cover, make sure that it is seated correctly without obstruction from carpet, floor mats, etc.

 **WARNING:** If the engine cover is not seated correctly, exhaust gases may leak into the motorhome, creating a dangerous and potentially lethal situation.

ENGINE COOLING SYSTEM

The engine cooling system requires regular, periodic service to operate at maximum efficiency. The condition of the engine coolant, hoses, and clamps should be checked annually. Make sure to follow the cooling system recommendations as outlined in your chassis engine owner's manual. If you notice, or suspect cooling system problems, make sure it receives immediate attention. Proper and safe operation of the chassis engine cooling system and other chassis functions depends on maintaining the vehicle per the instructions and schedules published by the chassis and engine manufacturers.

Most cooling system concerns are usually made apparent by an overheating symptom. Regular inspections to check the belt conditions and tension, damage to fan or fan shroud, and the condition of hoses and hose clamps should be a regular part of your motorhome maintenance program.

The mixture of the coolant used in the engine cooling system is a very important aspect of proper cooling system maintenance. A 50/50 solution (water/coolant) will protect the cooling system against outside temperatures down to -34 degrees F. Plain water in the cooling system could cause engine damage to the freezing or lack of corrosion protection. A 100% solution

of antifreeze could cause engine overheating because of its low heat transfer property. Pure ethylene glycol coolant also freezes at only -8 degrees F. (Ethylene glycol is commonly used as an anti-freeze in engine coolant.)

 **WARNING:** Ethylene glycol is a petroleum derivative which can ignite if exposed to high temperature, such as occurs on an exhaust manifold. The possibility of ethylene glycol igniting is increased if it is not diluted with water. It is important to properly dilute antifreeze with the proper mixture of water. Make sure to discuss the coolant needs of your vehicle with your chassis engine service representative.

PROPER LOADING AND WEIGHT DISTRIBUTION

Your recreational vehicle has been designed to carry loads within specified limits. Exceeding these limits will greatly affect the handling of the recreational vehicle. These limitations are defined in three ways:

1. Gross Vehicle Weight Rating (GVWR) — Maximum permissible weight of this motorhome. The GVWR is equal to or greater than the sum of the Unloaded Vehicle Weight plus the Net Carrying Capacity.
2. Gross Axle Weight Rating (GAWR) — Maximum load carried by an axle: sum of rating may be more than GVWR to allow for load variations.
3. Gross Combined Weight Rating (GCWR) — Value specified by the motorhome manufacturer as the maximum allowable loaded weight of this motorhome with its towed trailer or towed vehicle.

Check weight ratings of your recreational vehicle on the serial number identification tag on the recreational vehicle.

Additional terms used when discussing weight and distribution include:

1. Gross Vehicle Weight (GVW) — The total loaded weight of the recreational vehicle.
2. Gross Axle Weight (GAW) — The total loaded axle weight under any given load condition.
3. Unloaded Vehicle Weight (UVW) — Weight of this motorhome as built at the factory with full fuel, engine oil, and coolants. The UVW does not include cargo, fresh water, LP gas, occupants, or dealer installed accessories.

4. Net Carrying Capacity (NCC) — Maximum weight of all occupants including the driver, personal belongings, food, fresh water, LP gas, tools, tongue weight of towed vehicle, dealer installed accessories, etc., that can be carried by this motorhome. (NCC is equal to or less than GVWR minus UVW).

NOTE: When establishing the cargo capacity, weigh your motorhome with all water tanks as empty as possible. Do not allow anyone to be in the recreational vehicle when establishing this rating.

DO NOT assume that you can fill all tanks and all storage areas and be within the GVWR. Weights of stored items and passengers will vary greatly and will affect total weight of your recreational vehicle.

NOTE: Fresh water weighs 8.33 pounds per gallon. L.P. Gas weighs 4.5 pounds per gallon.

Always give careful consideration when loading your recreational vehicle so that items will be evenly distributed. Not only will the recreational vehicle handle and ride better, but you will have reduced tire wear and increased fuel economy. This will ensure that you have not overloaded one side or the other, affecting recreational vehicle handling. DO NOT store heavy items near the front or rear ends of the recreational vehicle.

It is recommended to empty the holding tanks before leaving on a trip, and as often as possible when traveling, to help keep weight reduced. Try to carry only as much fresh water as you will use when traveling. Sometimes, the water tanks can be used to balance the weight in the recreational vehicle.

It is also important to keep in mind when traveling, that all items stored inside and outside the recreational vehicle are secure, and all doors and drawers are secure. DO NOT add any type of rack or frame to any recreational vehicle frame or chassis part. The alteration to length and/or weight distribution may result in unstable handling, be a safety hazard, or could damage the recreational vehicle components. In any case, the recreational vehicle warranty may be affected.

COMPUTING YOUR LOAD AND LOAD DISTRIBUTION — (Motorized Recreational Vehicles)

In order to properly compute your load and load distribution, you must know both actual scale weights, and the GAWR and GVWR found on the Federal Certification Label on the motorhome. Weigh with all passengers, equipment, luggage, and fluids on board as you plan to travel with.

To weigh your motorhome properly, use the following procedure:

1. All passengers must be in their seats and the vehicle level. Place the front axle only on the scale. Check the weight against the front gross axle weight rating.
2. Pull forward so that both axles are on the scale. Check the weight against the gross vehicle weight rating.
3. Pull forward again so that only the rear axle is on the scale. Check the weight against the rear gross axle weight rating.



1. Front Axle Weight



2. Total Vehicle Weight



3. Rear Axle Weight

NOTE: The vehicle must be setting on level ground when weighing the front or rear axle separately. The weight distribution will be greatly affected if this is not done and the weights will be inaccurate.

Compare scale weights with capacities as shown in the following example.:

There are various weight ratings depending on the model and chassis manufacturer. This example uses weight ratings based on a hypothetical chassis. Other models are figured in the same way with their appropriate weight ratings. Remember, these examples are assuming a fully loaded coach; passengers, equipment, luggage, and fluids, just as you will be traveling with. *This example is hypothetical only. Your weights will vary. It is the procedure for establishing reserve capacity and weight balance that we are showing here.*

GVWR	14,500 lb.
GVW	<u>12,570</u> lb. from scale
Carrying Capacity:	1,930 lb.
Front GAWR	5,000 lb.
Front GAW	<u>4,000</u> lb. from scale
Front Axle Carrying Capacity:	1,000 lb.
Rear GAWR	10,000 lb.
Rear GAW	<u>8,890</u> lb. from scale
Rear Axle Carrying Capacity:	1,110 lb.

If at this point, any overload or imbalance occurs, the load will have to be distributed to compensate, and weighed again.

Once you become familiar with loading your motorhome, and know how to distribute the weight and which items you normally carry, make a list and diagram you can use for future reference. Plan your loading and storage so that emergency items are easily accessed.

Keep in mind that if you make any major changes in the items you take along, or you install additional equipment, that it will be necessary to re-weigh your motorhome. **DO NOT ASSUME THAT YOU CAN TOW ADDITIONAL VEHICLES BEHIND YOUR MOTORIZED RECREATIONAL VEHICLE**, as it may substantially affect your performance and structure of your vehicle.

WIDE BODY MOTORHOMES

NOTICE: Vehicles with overall body width greater than 96" are known as 'wide bodies' and have the advantage of more spacious interiors and innovative floor plans. Wide body vehicles are restricted to use on main highways in certain states. A vast majority of states allow for 102" body width on all highways and 102" body width is now allowed on all federal highways in the United States. Your dealer may be able to furnish more specifics.

If you are concerned about vehicle width, we invite you to consider other **Four Winds** vehicles offered in the standard 96" width.

DRIVING

Now that you have determined your vehicle's weight and balance you are ready to pull out onto the open road.

Once you get acquainted with your vehicle, you should find that it drives and handles much like a large passenger car with a few notable exceptions that include: length, height, width and weight.

The vehicle is equipped with more than adequate brakes, however, its stopping distance may be much greater than your automobile. Get used to it. Keep it in mind at all times and be alert to changing road conditions.

It would be helpful to take your new RV out to a stadium parking lot and spend some time getting the feel of the wider and longer vehicle.

Small fluorescent sports cones, available at sporting goods and toy stores, can be used to create turns and parking spaces. Dowels with small flags can be attached to make the cones more visible in the passenger's side view mirror. Practice parallel parking, backing and turns.

Afterwards, the cones can become an addition to your safety equipment.

Get your spouse to work with you, having them help guide you from both the passenger seat and from a position outside using hand signals.

The other vehicle characteristic that needs to be taken into consideration immediately is height. Read all "clearance" signs when approaching parking garages, drive-through windows and even underpasses on older highways. Also be careful of overhanging trees. Always use caution and when in doubt get out and look.

Don't forget any added equipment that may protrude higher than the standard factory height.

Passing and pulling out into traffic in your RV is going to be different than when driving your everyday vehicle. Generally speaking, it will take more time, thus, more distance to pass when it necessitates driving in an on-coming lane of traffic.

It will take more time to clear an intersection from a dead stop. Allow more distance between cars.

Because your RV is longer and wider than your other vehicles, a bit more attention must be paid to cornering. Practicing in a stadium lot is helpful, as indicated earlier.

The main idea is to pull several feet past the apex of the corner before initiating the turn. This is to give extra room for the rear inside wheels to clear the inside curb. Instead of cutting corners, learn to use the entire roadway by bringing the vehicle closer to the center stripe of the street or road you are entering. However, do not swing "out" or over the centerline of the road you are turning off.

Because of the extra room your vehicle needs to clear the inside curb, you must be more fully aware of the traffic that you are turning into (what becomes the oncoming traffic after the turn). Note how close the vehicles are to the center line and especially if they are over the center line and into your lane.

HILLS, DALES AND MAKING THE GRADE

Your RV adventures are going to take you to new and exciting areas of the country, including those areas with breathtaking views. In other words: hill country.

Driving in hilly or mountainous terrain isn't any more difficult than driving on the flat plains of Kansas if the driver uses the vehicle properly.

The main culprit of hilly or mountainous driving problems is overheating. And it's not just the cooling system that suffers this malady.

Preventing problems is as simple as following your chassis manufacturer's driving instructions for this type of terrain. The main thing to remember is to reduce speed and drive in the appropriate gear, usually something other than Drive.

On downgrades a lower gear helps to assist in braking, thus preventing overheating of the brakes and the possibility of poor brake performance.

The modern RV, unlike its forerunners, is equipped with front disc brakes that are more powerful and more fade resistant than the old drum and shoe combinations of the past. However, if abused, they can deliver less than satisfactory performance.

Upgrades are handled in the same manner: a lower gear and speed.

TRAILER TOWING

Trailer packages that include high quality tow hitches are available as an option on **Four Winds International** RVs. They are designed to meet Class specifications for your particular vehicle.

Four Winds International accepts no responsibility for damage to the chassis and other components resulting from towing loads greater than its designated class specifications. You will also need to consider the gross combined weight rating of your motor before towing a trailer or car.

Towing an object such as a boat and trailer or car behind an RV results in added driving considerations.

 **CAUTION:** Consult with your selling dealer to determine the GCWR of your vehicle. Do not assume that you can tow a vehicle which happens to be within the capacity of the hitch. It may exceed the total GCWR of the motorhome.

When purchasing a new or borrowing an unfamiliar trailer it would be best to take a drive around the area of your home prior to setting out on a longer trip.

Include a stint at highway speeds to confirm the trailering characteristics of your RV and the particular trailer you are using.

TONGUE LENGTH AND TONGUE WEIGHT contribute much to good trailering characteristics. Twelve to eighteen inches of additional tongue length can make a world of difference in a trailer's "attitude".

Weight distribution of the trailer cargo has a great influence on handling qualities. For instance, a fishing boat with a small engine tows well; however, buy a new, larger, heavier outboard motor for the boat and trailering becomes a nightmare.

EMERGENCY STOPPING AND TOWING

If an emergency ever requires you to be stopped, be sure to follow these guidelines:

1. Pull off the road as far as possible.
2. Turn on your hazard warning flashers.
3. If traveling at night, use three red warning indicators such as flares, reflectors, or lanterns as required by the Uniform Vehicle Code and Model Traffic Ordinance as follows:
 - a. Place the first at traffic side of the vehicle, directed at the nearest approaching traffic.
 - b. Place the second 100 feet behind the recreational vehicle in the center of the lane and toward approaching traffic.
 - c. Place the third 100 feet in front of the recreational vehicle in the center of the lane and away from the traffic approaching from behind.
4. Always stand off the road.

NOTE: Curves and/or hills may affect the safe placement of warning indicators.

If the emergency requires that your motorhome be towed, follow these guidelines:

1. Review the Chassis Owner's Manual for proper towing guidelines.
2. The motorhome SHOULD be towed from the front. NEVER tow the motorhome from the rear.
3. Use an approved tow truck normally used for towing large vehicles.
4. Tow with the parking brake released and the transmission in neutral.
5. Make sure the front wheels are lifted at least four inches off the ground, and that the rear of the motorhome has adequate clearance.
6. It may be necessary to disconnect the drive shaft, or use a dolly under the rear wheels.

At the rear wheels will not tow, it will be necessary to place the rear wheels on a heavy duty dolly, and tow from the front. Make sure that there is nothing loose or jutting out from the motorhome which could be a safety hazard while towing.

 **WARNING:** Never tow the motorhome at a speed greater than 50 MPH. Never allow anyone to ride in the motorhome while it is being towed. Make sure to review the chassis owner's manual supplied with your unit for any additional requirements or cautions concerning the towing of the motorhome.

FUEL PUMP COLLISION SHUTOFF SWITCH (Ford)

If your motorhome is involved in a collision, it is possible that an inertia switch in the fuel pump circuit will open, shutting down the flow of fuel to the engine. This is a safety feature designed to help keep raw fuel from spilling out and creating additional danger. When this inertia switch has been tripped, it is necessary to manually reset it before the motorhome can be restarted and moved. Review your chassis owner's manual for the location of the switch and instructions for resetting.

 **WARNING:** If you see or smell gasoline at any time other than during fueling, do not reset the switch. Make sure that there is no damage to fuel related components before resetting the inertia switch.

FUEL

FUEL RECOMMENDATIONS

Pay close attention to the fuel recommendations outlined in your chassis literature. Also, remember that the motorhome generator may be fueled by the same system as is used to fuel the motorhome chassis engine, and you should consider the gasoline requirements of the generator when making a decision on the type of fuel to use. Check both the chassis and generator owner's manuals to help you establish the type of fuel best suited for this dual application.

NOTE: Using fuel with the proper octane rating can add to your driving economy. Make sure to check the chassis owner's manual for recommended octane levels for your motorhome.

FUEL FILLING

Always remove the fuel cap slowly, allowing pressure built up in the fuel tank to escape gradually before removing the cap. If you spill fuel on the motorhome, clean it up immediately, since fuel can dull or soften paint and damage other surfaces. If you should lose your fuel cap, it should be replaced as soon as possible, with a cap of the same type.

 **WARNING:** Be extremely careful when fueling your motorhome. Always shut off the engine, do not smoke, and shut off all pilot lights before adding fuel. Fuel spills represent a serious fire hazard, and should be cleaned up immediately. Never restart the engine, or relight pilot lights while raw fuel is present.

CARBON MONOXIDE SAFETY PRECAUTIONS

Be aware of carbon monoxide poisoning and its symptoms:

1. Dizziness
2. Severe Headache
3. Vomiting
4. Weakness and Sleepiness
5. Muscular Twitching
6. Throbbing in Temples

If anyone in the recreational vehicle experiences any of these symptoms, shut off the engine, and immediately go outside into fresh air. Get medical attention as soon as possible.

Never run the engine unless you are sure that exhaust gases will be safely dispersed into the atmosphere. Always be sure that tail pipes remain unblocked and windows near the exhaust are closed.

DO NOT alter or modify any component of the exhaust system at any time. Inspect the exhaust system at regular intervals for damage. If you suspect or locate damage to the system, have it repaired immediately.

 **WARNING:** Exhaust gas is deadly! It contains carbon monoxide, a poisonous gas that can cause unconsciousness and death. It is an odorless, colorless, and tasteless gas formed during combustion of fuel in either the motorhome or generator engines.

 **WARNING:** Never sleep while the engine is running. It is impossible to know if you are being affected by carbon monoxide gas while asleep.

CHASSIS FUNCTIONS

DASH CONTROLS (Class C Mini Motorhomes)

The controls in your mini motorhome are all chassis factory installed. Refer to your chassis owner's manual for complete instructions.

DASH CONTROLS (Class A Motorhomes)

You should thoroughly familiarize yourself with the various controls, instruments, and indicators available to you in your motorhome. Performance and safety can be enhanced by the driver who fully understands each one, and how to use them.

IMPORTANT: The chassis owner's manual furnished with your motorhome has complete information for operating and maintaining chassis functions. Make sure to read and follow all instructions in the chassis owner's manual, paying particular attention to all precautions and warnings associated with its use.

TYPICAL CHASSIS INSTRUMENT PANEL (Class A Motorhomes)

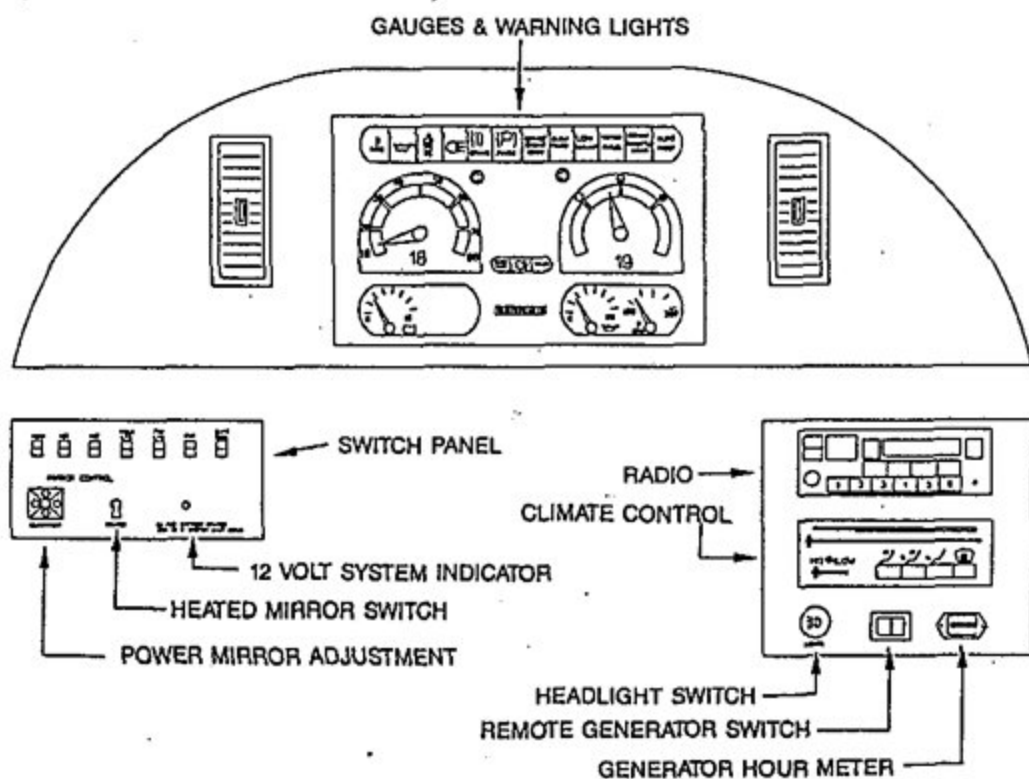

CHASSIS INSTRUMENT PANEL

Use of gauges, controls, and indicator lights are covered in your chassis owner's manual. Be sure to read all instructions in the chassis owner's manual. Always pay attention to and follow the precautions, warnings, and maintenance instructions outlined there.

If the appearance or placement of the gauges, instruments, and controls does not exactly match the illustration in your chassis owner's manual, the instructions for their use will still apply.

Steering column controls and functions are also covered in the chassis owner's manual.

HEADLIGHT SWITCHES

The three position headlight switch controls the instrument, parking, marker, tail and headlights as illustrated. Rotating the Rheostat switch controls the brightness of the instrument lights.

WIPERS

Left and right hand wipers are activated by a single control. This control has an intermittent wiper feature. Windshield washers for both sides are activated by pressing on the center of the wiper control. Some motorhomes may have the wiper controls as part of the turn signal level.

NOTE: You should check the level of the washer fluid regularly. Use a washer fluid that is intended for this purpose to clean better and offer protection from freezing. **DO NOT** use additives such as radiator anti-freeze in the washer fluid that might cause damage to either the washer system or the motorhome finish.

NOTE: To prevent possible damage to your windshield or wiper blades, do not operate the wipers when the windshield is dry.

GENERATOR REMOTE SWITCH AND HOUR METER

Controls the remote ON/OFF operation of the generator. Make sure to read all information on generator operation elsewhere in the owner's manual.

CIGARETTE LIGHTER

To use the lighter, press in all the way and let go. It will pop out by itself when it is ready.

NOTE: Do not hold a cigarette lighter in with your hand while it is heating. If you do, it won't be able to back away from the heating element when it's ready. That can make it overheat, damaging the lighter and the heating element.

HEATED MIRROR SWITCH

This switch activates optional heaters in each of the outside mirrors that defrost them when required. Turn the heaters off when the mirrors are defrosted.

POWER MIRROR ADJUSTMENT

The optional power mirror functions for both left and right hand mirrors are controlled by this single switch. A center switch is used to select either the left (L) or right (R) hand mirrors. The outer control is used to control the movement of the mirror selected. Pressing on one of the four sides moves the selected mirror in the direction indicated by the arrow on that side.

Always adjust mirrors for proper vision before starting and moving the motorhome. Each side is equipped with both normal and wide angle mirrors for more complete vision.

CLIMATE CONTROL (Class A)

The climate control enables the driver to control the temperature, amount and direction of the air discharged from the heating/air conditioning system.

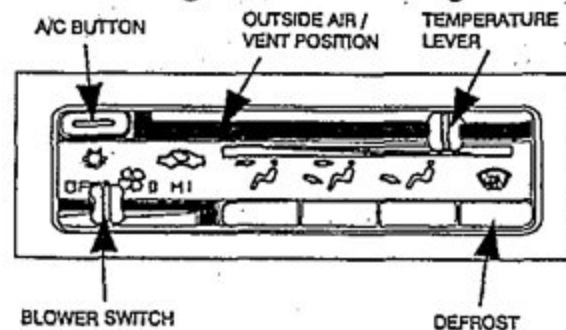

A/C CONTROL PANEL

ON-OFF

The **OFF** position on the blower switch will shut off the blower and A/C system. The blower must be turned **ON** for the A/C to operate.

AIR CONDITIONING

With the blower in the **ON** position, depress the **A/C** button. A blue indicator in the center of the button will show that the system is operating.

The A/C is turned **OFF** by pressing the button a second time.

NOTE: The A/C will not function if the outside temperature is below 40 degrees F.

TEMPERATURE CONTROL

The slide lever controls the temperature of the discharge air. Slide the lever to the right (red area) for heat, and to the left (blue area) for cooler temperature.

RECIRC CONTROL

When the lever is moved to the extreme left it is in **RECIRC** mode. **RECIRC** stops the flow of outside air through the A/C system, and should be the mode of operation when maximum cooling is desired.

BLOWER CONTROL

One of the best ways to control temperature is by changing the speed of the blower. There are four speeds available.

VENT

Outside ventilation is available by sliding the temperature lever to the right of **RECIRC**.

AIR DISTRIBUTION

To achieve the maximum comfort in your motorhome, the air must be directed where it is needed. The air control buttons give the driver the ability to select where the air will flow. Only one button can be depressed at a time.

PANEL

Air is discharged through the dash louvers. These louvers can be adjusted for maximum comfort.

FLOOR

Air is discharged through the floor outlets. A small amount of air is directed to the windshield for defrost.

BI-LEVEL

The air flow is split between the floor and dash louvers. This mode provides maximum air flow and is recommended for heater operation.

DEFROST

Air is discharged through the defrost vents. The A/C automatically comes on (above 40 degrees F.) to prevent fogging of the windshield. A small amount of air is directed to the floor for comfort.

IMPORTANT OPERATING TIPS

WINTER OPERATION

The discharge air will heat up faster if the blower is operated on lower speeds until the engine is hot.

SUMMER OPERATION

MAXIMUM COOLING

1. Use **RECIRC** and **HI** blower for quick cool down.
2. A lower blower speed produces cooler air.
3. Close all windows and vents to hot, humid outside air.
4. Close curtains which do not obstruct the driver's vision.
5. Do not block the recirc door grille (under passenger's feet).

WINDOW FOGGING

Vehicle windows tend to fog on the inside during rainy or humid weather. To clear the windows, do the following:

1. Press **A/C** and **PANEL** buttons.
2. Use the dash louvers to direct the air to the side windows.
3. For windshield fogging, use **DEFROST**.

CARE AND SERVICE

1. Keep the condenser and radiator free of bugs and debris.
2. During periods of little use, turn the compressor on monthly to keep the compressor lubricated.
3. Periodically inspect belts and hoses for wear and proper tension.



WARNING: The air conditioning system contains refrigerant under high pressure and should be serviced by qualified personnel only. Improper service methods could cause serious personal injury.

RADIO

Your motorhome includes a stereo cassette player with AM-FM radio. Consult the radio owner's manual for complete operation instructions.

DASH SWITCH PANEL

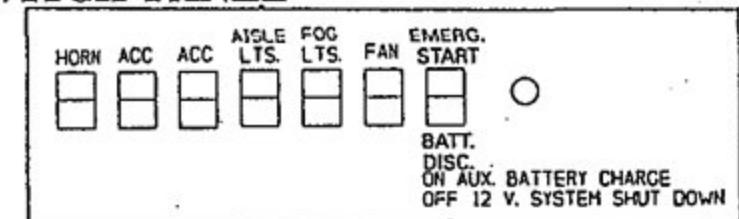

BATTERY DISCONNECT SWITCH

The battery disconnect switch allows you to easily disconnect the auxiliary house batteries from electrical circuits, preventing unwanted discharge during extended non-use.

There are three main uses of the battery disconnect:

1. Prevent unwanted discharging of batteries during extended periods of storage.
2. Prevent shorts or fire hazard while working on the 12 volt electrical system.
3. Prevent overcharging of batteries if the motorhome is attached to shoreline power for extended periods.

When activating, place the switch in the ON position. This battery system will now be operational.

Place the switch in the OFF position to disconnect 12 volt circuits. If the disconnect switch is in the OFF position, 12 volt circuits will not be operational even if 110 volt power is still being supplied by the shoreline connection or by the generator. Also, the batteries will not be recharged by the convertor, the generator or the alternator in this situation.

NOTE: It is not necessary or advisable to use battery disconnect switches as a substitute for turning off the various 12 volt applications available in the motorhome.

NOTE: If 12 volt functions are not working, or the batteries are not charging, be sure to check that the battery disconnect switch has been placed in the ON position.

FAN

The fan switch turns the power on or off to the optional overhead defroster fans. Each fan can be operated separately with individual switches on each fan if this switch is in the ON position.



WARNING: Do not remove the protective cage from the fan. Do not allow anyone to place fingers or other objects into the protective cages.

FOG LIGHTS

The fog light switch controls the on/off operation of the optional fog lights. If your motorhome is not equipped with fog lights, it will be prewired for them. The wires should be located under the front hood.

ISLE LIGHTS

The isle light switch operates the on/off function for the optional isle lights. It is wired to the front fuse block under the hood.

ACCESSORY (2)

These switches are placed in the dash as a convenience for the owner who wishes to install additional 12 volt functions to the vehicle. They are wired to the fuse block on the front firewall under the hood.

HORN

The horn switch activates the optional horns. When the switch is in the ON position, the horns can be controlled by pressing on the horn button on the steering wheel. When the switch is in the OFF position, the regular chassis horn will be the only horn operational. This switch is wired to the front fuse block under the hood.

HYDRAULIC POWER LEVELERS (Optional)

General Description

The optional power leveling system allows you to quickly level your motorhome from the driver's seat by adjusting levers and watching a panel of indicating lights.

The following instructions are for the HWH 200 Series System. You should refer to the separate manual for the levelers for additional information.



CAUTION!

READ THE ENTIRE OPERATOR MANUAL BEFORE OPERATING.

BLOCK FRAME AND TIRES SECURELY BEFORE CRAWLING UNDER VEHICLE. DO NOT USE LEVELING JACKS OR AIR SUSPENSION TO SUPPORT VEHICLE WHILE UNDER VEHICLE OR CHANGING TIRES. VEHICLE MAY DROP AND/OR MOVE FORWARD OR BACKWARD WITHOUT WARNING CAUSING INJURY OR DEATH.

KEEP ALL PEOPLE CLEAR OF VEHICLE WHILE LEVELING SYSTEM IS IN USE.

THE JACKS MAY ABRUPTLY SWING UP WHEN THE FOOT CLEARS THE GROUND OR WHEN JACK REACHES FULL EXTENSION.

NEVER PLACE HANDS OR OTHER PARTS OF THE BODY NEAR HYDRAULIC LEAKS. OIL MAY PENETRATE SKIN CAUSING INJURY OR DEATH.

WEAR SAFETY GLASSES WHEN INSPECTING OR SERVICING THE SYSTEM TO PROTECT EYES FROM DIRT, METAL CHIPS, OR LEAKS, ETC. FOLLOW ALL OTHER APPLICABLE SHOP SAFETY PRACTICES.

DO NOT OVER EXTEND THE REAR JACKS. IF THE WEIGHT OF THE VEHICLE IS REMOVED FROM ONE OR BOTH REAR WHEELS, THE VEHICLE MAY ROLL FORWARD OR BACKWARD, OFF THE JACKS.

NOTE: KEEP STORE LEVERS IN THE STORE/TRAVEL POSITION WHEN JACKS ARE NOT IN USE.

Control Identification

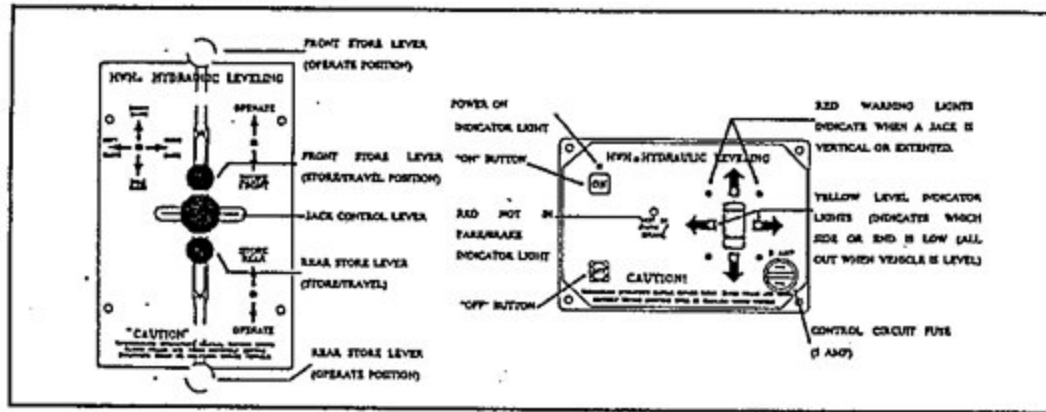

Control Functions

ON BUTTON: This is the "ON" button for the leveling system. It provides control power to operate the electrical relay on the pump, the leveling lights, and the 4 red warning lights. It does not control power to the master "JACKS DOWN" warning light.

POWER ON LIGHT: This light indicates the system is "ON".

NOT IN PARK/BRAKE: This indicator light is "ON" when the light panel is "ON" but the hand/auto park brake is not set.

LEVELING INDICATOR LIGHTS: If a yellow LEVELING light is on, that indicates a side or end of the coach is low. Extend the appropriate jack pairs to put out the yellow light. Only one yellow leveling light should be on at a time. The coach is level when all yellow lights are out.

WARNING LIGHTS: A red WARNING light will be on whenever the corresponding jack is vertical, provided the ignition switch is in the "ACCESSORY" or "ON" position and the system is "ON". Some coaches are equipped with a dash mounted master "JACKS DOWN" light which will be "ON" when one or more jacks are vertical, provided the ignition switch is "ON".

OFF BUTTON: This button turns off control power to the leveling system but not the master warning light.

STORE LEVER: These two levers are used to retract the jacks into the store position for travel. They must be in the operate position for leveling.

JACK CONTROL LEVER: Jacks are extended in pairs by pushing the jack control lever to one of the raise positions. This movement of the lever activates the pump and directs hydraulic fluid to the jacks. When the lever is released it will return to the neutral (center) position, turning off the pump and stopping jacks in position.

Site Selection

Park with the front of the vehicle facing downhill if possible. Care must be taken not to raise the rear of the vehicle too high or the vehicle may roll forward or backward off the jacks. If parking on soft ground or asphalt paving, wood blocks or pads must be placed under the jacks.

Leveling Procedure:

1. Place gear selector in the parking position and apply brake. If the hand/auto park brake is not set, the "NOT IN PARK/BRAKE" light will come on and the system will not operate. Block wheels securely.
2. Turn ignition switch to "ON" or "ACCESSORY".
3. Push the "ON" button on the light plate. The POWER ON light will be lit.
4. Move the front and rear store levers to the operate position. Nothing should happen at this time. See figure 1.
5. Swing the jacks to the vertical position by pushing the center jack control lever to FRONT RAISE then REAR RAISE. The respective red WARNING light will light as soon as the jack swings vertical. Check that all jacks have swung to the vertical position. Place pads under jacks if necessary at this time. See figure 1.
6. A lit yellow LEVEL light indicates that end or side of the coach is low. Move the jack control lever to the raise position to extend jack pairs corresponding to a lit yellow light. Extend jack pairs accordingly until all yellow lights are out. Only one yellow light should be lit at a time. If the ground is too uneven, the jacks may not have enough stroke to level the coach. The coach may have to be moved. Remember if the rear of the vehicle is lifted too high, the coach may roll forward or backward off of the jacks.
7. After the coach is level, the jacks not used for leveling may be extended until they touch the ground. Do this by pushing the jack control lever to the rear and/or front as needed to extend any remaining jacks. Do not use the right or left extend positions. This provides additional stability against wind and activity in the coach.
8. Push the "OFF" button on the light panel.
9. Turn off the ignition switch.

NOTE: The leveling system should be cycled once a month or whenever the vehicle is used, to keep the system in operating condition.

Retract Procedure

1. Make sure people and equipment are clear of the vehicle.
 2. Move the STORE levers to the "STORE" (travel) position. This will allow the jacks to retract. As soon as a jack foot clears the ground, the jack will swing horizontal and continue to retract, see Figure 2.
- CAUTION:** The store levers should be kept in the "store" position while traveling to keep the jacks in the horizontal position.
3. With the ignition switch in "ON" or "ACCESSORY", and the system turned "ON", check that the red WARNING lights and the master JACKS DOWN lights are all out.

CAUTION: Do not rely solely upon the warning lights. It is the operator's responsibility to check that all jacks are up before moving the vehicle.

4. Push the "OFF" button on the light panel. Turn ignition off.

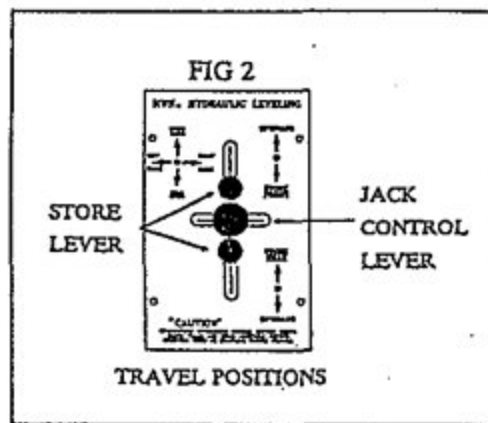
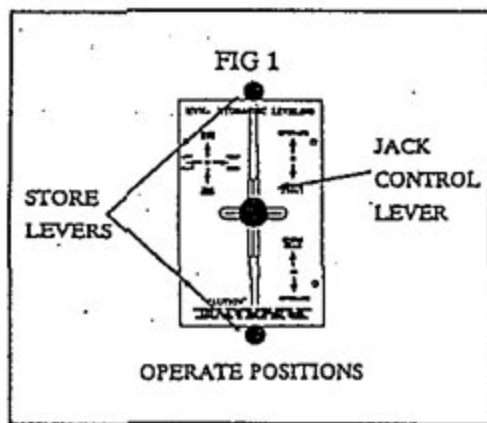

DRIVER AND PASSENGER SEATS

Both the driver's and passenger's seats have various methods of controlling comfort.

1. **Reclining Back** — A control lever on either the left or right sides of each seat controls the reclining angle of the back rest. Lift up on the lever, lean back to position seat angle in the desired location, then release the lever to lock the back rest in place. To return the back rest to the original upright position, lift up on the control lever. It will automatically return to its normal upright position.
2. **Seat Swivel** — A control lever on the side of both seats controls the swivel function of the seats. Push the lever forward to release the detent on the swing mechanism. Once the lock is released, the seat may be rotated either left or right to any position.
3. **Forward & Back Adjustment** — The forward and back sliding action of the seat is controlled by a lever on the lower left side of the seat. To adjust, pull the lever outward to release the latch, and slide the seat to the desired position. Make sure the seat locks into the position you have selected.
4. **Arm Rests** — Arm rests are provided on both the left and right hand sides of the driver and passenger seats. They may be rotated up and out of the way when not required.

NOTE: Sometimes it may be necessary to adjust the sliding position of the seat and the tilt of the back, to enable the seat to be rotated without obstruction from sidewalls or items to the rear. Some models may not allow complete seat rotation.

WARNING: Do not adjust the seat position while the motorhome is in motion. Never place the driver's seat into a position where visibility would be impaired while driving.

SEAT BELTS

Seat belts are a very important safety feature in your motorhome. Anyone riding in the motorhome should wear a seat belt at all times while the motorhome is in motion. Children should be properly restrained rather than being held by an adult.

To fasten seat belts, insert the tongue into the buckle until you hear a snap and feel the latch engage. Adjust the belt to the proper position; snug and as low as possible around the hips, not around the waist. Never have more than one person use an individual seat belt. Also, it is not possible to belt persons who are lying in a bed. To unfasten the seat belts, push the release button in the buckle and allow the belt to unlatch.

WARNING: All motorhome occupants should wear their seat belts for maximum protection in the event of a collision. For young children, infant and child restraints should be obtained and used in accordance with the instructions provided by the manufacturer of the restraints. In some areas, seat belt and/or child restraint use is required by law.

WARNING: Failure to adjust the seat belt properly could increase the chance of injury in the event of a collision.



REAR VISION TV MONITOR SYSTEM

Your motorhome may be equipped with the optional rear vision TV monitor system. This system gives a televised view of what is behind the motorhome. It is used as an aid in backing the motorhome, and can also be used for greater field of vision when driving in heavy traffic.

The motorhome ignition must be on to power the system. The picture is automatically activated when the motorhome is shifted in reverse. Push the standby switch down to receive the picture at any time. Push the switch out to receive in reverse gear only. Picture brightness can be controlled by rotating the reception switch. A contrast control is also provided to adjust the picture further. Adjust by rotating the switch.

Contrast and bright controls are provided to compensate for changes between day and night use. Push the light/darkness switch in for day use, push again to release for night use. Never operate the monitor in the on position for extended periods of time, this may result in an "image burn" on the monitor.

Make sure to check the mirrors when driving and backing, for a more complete field of vision. The TV camera is equipped with a wide angle lens that can initially present an image that may be deceiving. Make sure to practice backing in a safe place, using the monitor to become accustomed to its operation.

INTERIOR CONTROLS AND OPERATIONS

Your new RV from **Four Winds International** offers virtually all the comforts of home while out on the road. These systems are of the most modern design available, just as the similar systems in your home, however, the RV's systems may be of different design, and construction than those found in your home.

The following instructions are for items inside the recreational vehicle which are general in nature. Instructions for the operation of appliances and conveniences not found here can be found in other sections dealing directly with appliances and systems. Check the index for the location of specific information.

LIVING QUARTERS

Construction of your **Four Winds International** RV is the best in the industry when it comes to strength and energy conservation. These new building techniques greatly reduce air exchange between the inside and outside, thus creating a very airtight vehicle.

This creates some problems than can easily be resolved by airing out the vehicle on a regular basis, especially in warm, humid conditions and after storage. Also, during prolonged cold weather where the heating system is in use, other procedures should be followed as detailed in the last suggestion in the Safety portion of this manual.

CONDENSATION

Condensation can be more of a problem in the well-built RV than in the average home. Bathing, dish washing, cooking, washing and drying clothes, and the use of unvented gas burners all contribute to the added moisture level.

A few easy procedures can help reduce the problem and include closing the door to the bathroom and opening the window vent during bathing and for a short period afterwards; using the overhead vent while cooking, and making sure the clothes dryer is vented to the outside of the unit. Also, don't hang wet clothing inside the RV to dry.

Taking care to keep down the amount of condensation will help prevent your unit's insulation from becoming damp and dropping its efficiency.

During the Summer always try to park in a site that will be shaded during the hottest part of the day. Window awnings are very helpful in keeping inside temperatures down.

Also, during hot weather, be aware that air conditioners need to operate on voltage of 110 to 120 and anything lower can result in overheating of the motor and excessive wear resulting in shorter life for the unit. Dim lights and a poor, narrow television picture are indicators of a low voltage source. Use a volt meter to check outside electrical sources.

WINDOWS

All the windows that open in the recreational vehicle are operated by sliding them back and forth. To operate, pivot the latch to release it from the locked position, and slide the window to open. When closing, slide the window fully closed, and pivot the latch back to the fully locked position. The screens will also slide open and closed if required for an emergency exit.



WARNING: To avoid exhaust gas entry into the motorhome, keep windows closed when the chassis or generator engines are running.

DOORS, DRAWERS AND STORAGE COMPARTMENTS

Cabinet and closet doors in the recreational vehicle have door fasteners, or pneumatic stops, which prevent them from accidentally opening during travel. Drawers throughout the recreational vehicle have travel stops which keep them from sliding out when in motion (under normal driving conditions).

To open drawers, lift up first, then slide out. When closing drawers, make sure they drop slightly into the travel position.

Make sure before operating your recreational vehicle, that all cabinet doors and drawers are closed, and cabinet contents are secure. Retract and secure sliding doors in the bath area, as well as the bath door, to prevent noise and/or damage while traveling.

Under Sofa Storage (Some Models) — To access the available storage under the sofa by lifting the front seat section and pulling towards you. Do not lay seat down completely.

Under the Bed Storage — There may be a large storage area located under the bed. It is accessed by grasping the end ledge at the foot of the bed and lifting. Make sure before lifting, that there is nothing on the bed that will restrict its movement, or add extra weight.

Pneumatic struts on both sides of the storage compartment aid both in lifting, and holding the bed in the upright position. When storing items under the bed, be sure to leave space in the storage compartment for the struts when the bed is closed.

When lowering the bed, there will be some resistance felt at first, because of the struts. Be sure to keep both hands on the end ledge all the way down to the closed position to avoid having the bed suddenly drop shut.

Store items in the areas designated for storage. **DO NOT** store anything in the area reserved for the converter and electrical panels or the water tank and pump.

 **WARNING:** Use caution when lowering the bed to keep hands and fingers at the edge of the end ledge provided; and not on the side or further back than necessary, where you may encounter pinch points.

SEATING, TABLES AND ADDITIONAL BEDS

Depending on which model and options you have in your recreational vehicle, seating will include some combination of the following:

1. **Sofa** — The sofa will comfortably seat three adults. It also converts to a bed by lifting the front section and pulling toward you. The sofa back follows and pivots down into a prone position. To reconvert back to a sofa, lift the front and push back and down into place. The sofa back will follow and pivot up into its upright position automatically. When reconverting to the sofa configuration, make sure to pull the seat belts out to their usable positions.
2. **Lounge Chair** — The lounge chair has controls on the bottom right and left sides under the chair skirt that controls the swivel and side to side action of the chair.
3. **L-Shape Sofa** — This sofa will comfortably seat 3-4 adults. It also converts into a bed by pulling out the two drawers on the right and lifting the drawer top. Pull out the two or three seat cushions and lay on top of the drawers.

4. **Dinette** — The dinette will seat four people. Storage and/or various systems components can be accessed from above by removing the seat cushions and lifting the seat supports.

Pedestal Type Dinette — The dinette can also be converted into an additional bed if required. To convert, lift the table top off of the two support posts. Remove the support posts from the floor and lay them down between the seats. Insert the table top between the seats on the ledges provided. Loosen the seat cushion from the velcro fasteners and slide each together to form the bed. Reverse this process when reconverting to the dinette configuration.

Wall Mounted Type Dinette — Lift the isle side of the table and unhook from side wall and swing into place. The table supports on the dinette base.

5. **Fold-Down Lounge Table** — This table is stored in a folded position next to the lounge chair. To raise for use, pull out on the bottom to release it from its securing catch, and swing up. When raised, reach under the table and swing the supporting leg down until it locks into position. Adjust the length of the support leg, so that the table will be level when resting on it. To adjust the support leg length, pull back on the spring clip, releasing the detent from the adjustment hole it is presently in. While holding the spring clip back, slide the leg to the desired length, then release the spring, allowing the detent to lock into the new hole.

To fold back for storage, reverse the previous procedure; shorten the support leg, and folding the leg up against the bottom of the table top. Lower the table top, and push in on the bottom to secure it into the catch that keeps the table from moving while traveling.

7. **Breakfast Bar** — The breakfast bar has two movable cushioned chairs. Since these chairs are not permanently attached to the floor, and not equipped with seat belts, they should not be occupied while the recreational vehicle is in motion. These chairs should be stored securely while the vehicle is in motion.



These chairs are not for occupancy while vehicle is in motion.

OVERHEAD VENTS

Vents are provided in the recreational vehicle to circulate fresh air and exhaust odors.

1. **Bathroom Power Vent** — The power bath vent has dual controls to operate both opening and closing, as well as the exhaust fan. A hand crank controls opening and closing and adjustment of the vent cover, while a push button turns the exhaust fan on and off. Make sure to turn the fan off before closing the vent. Also be sure to remove any debris that falls into the vent that may restrict its operation.

WEATHER CENTER AND CLOCK

CLOCK — The clock is powered by a single "AA" size battery, which is inserted in the back. To set the time, remove cover of the clock and turn the hand setting knob on the back of the clock either clockwise or counterclockwise. If the clock begins to slow down or stop, this indicates a weak or dead battery, and it should be removed and replaced. A bad battery can leak and cause damage to clock components.

BAROMETER — The barometer will automatically record barometric pressure changes wherever you may be.

HYGROMETER AND THERMOMETER — The hygrometer measures the moisture content of the air (within the recreational vehicle), while the thermometer measures the actual inside temperature. Temperature and humidity go hand in hand, because temperature determines how much moisture the air can hold, in turn affecting relative humidity. By monitoring and controlling both temperature and humidity, you can determine the degree of comfort in your recreational vehicle.

EXTERIOR OPERATIONS

The following instructions are for items on the outside of the recreational vehicle. Instructions for the operation of appliances and convenience not found here can be found in other sections dealing directly with appliances and systems. Check the index for the location of specific information.

ENTRY DOOR

The entry door consists of both an exterior door and a screen door used for ventilation when the recreational vehicle is parked.

DO NOT attempt to drive the recreational vehicle with the doors open. DO NOT drive the recreational vehicle with the outer door open and the screen door closed. The doors may be damaged, and it is a safety hazard.

When driving, it is a good idea to keep the door locked to prevent unintended entrance from the outside when stopped. Two types of locks may be provided with the outer door. The handle lock for normal security, and a dead bolt lock for additional security.

The screen door can be attached to the outer door. A sliding panel on the screen door permits access to the handle on the outer door to prevent unnecessary handling of both doors.

Separate keys are provided for both types of door locks. It is a good idea to keep a record of the key numbers in a safe place, should it become necessary to have duplicate keys made.

DRIVER SIDE DOOR (Class A Only)

If you are equipped with a driver side door, make sure to use sufficient care when entering and exiting through it. Use the hand hold provided for additional safety. Make sure that your shoes are not slippery and that ice or other slippery substances have not accumulated on the steps provided. Take care before exiting the driver's side, to check the side mirror for obstructions or oncoming traffic.

STEP

A manual operating step is provided as standard equipment on most recreational vehicles. To extend the step, lift up on the step and pull forward. The step is held in place by a detent on each side. To retract the step, lift the step out of the detent, and push back to the original stored position. Make sure that the step is secure in the retracted position before moving the recreational vehicle.

Make sure to keep your fingers away from the sliding mechanism when extending or retracting the step.

POWER STEP

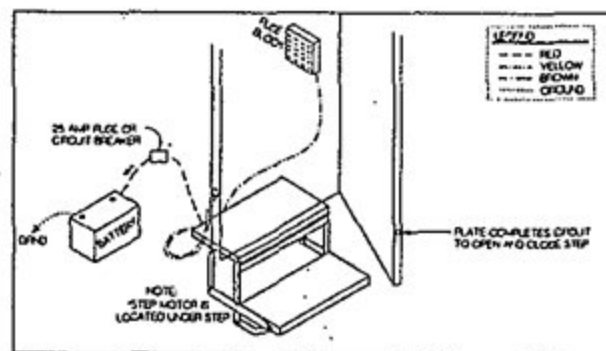

When the optional power step is activated, it extends and retracts automatically when the door is opened or closed. There are two ways to control the operation of the step:

Switch Panel — Power to the step may be turned on and off with the rocker switch located just inside the door. When on, the step will extend whenever the door is opened, and retract when the door is closed. The step may be maintained in the extended position by placing the switch in the off position after the step is lowered. To maintain your battery this switch should be off during storage.

Ignition Switch (some models) — Whenever the Ignition Switch is on, the power step is automatically activated. This will prevent accidentally driving with the step lowered, since it would retract with the door closed.

A light on the underside of the step adds security when entering and exiting the motorhome at night.

WARNING: Make sure before exiting the recreational vehicle, that the step is activated and/or extended. Because of the height of the recreational vehicle, you may accidentally slip or fall if attempting to exit without use of the step. If the step will not operate, use extra care when exiting. Never activate the step when someone is using it, and be sure to keep hands, feet, children, and pets away from the mechanism when activated.

STORAGE

Your recreational vehicle is equipped with numerous outside storage compartments. Each door can be locked for security.

Do not overload outside storage compartments with heavy densely packed items. Remember that any weight added to the recreational vehicle effects the overall vehicle weight. Also remember to check side to side weights, since putting an extremely heavy item on one side or the other will effect proper load distribution. Check the index for additional information regarding weighing and loading of the recreational vehicle.

Keep any emergency items stored in outside storage compartments easily available, where they can be reached without unloading the entire contents of the compartment.

NOTE: Make sure storage compartment doors are closed, latched, and contents secure before starting and moving the recreational vehicle.

WARNING: When closing the storage compartment doors, make sure that hands and fingers are clear of hinges and openings.

LADDER AND ROOFTOP STORAGE

The ladder located on the rear of the recreational vehicle is used to climb to the roof to either perform maintenance on the roof mounted items, or to store items on the roof.

Make sure before climbing the ladder, that your shoes are not slippery and that there is no ice or other slippery substance on the ladder.

Do not step on the very rear portion of the roof where the fiberglass from the rear walls wraps to the roof.

Remember if storing items on the roof, to keep vehicle weights and weight distribution in mind. Do not store items on the roof that could damage the roof. Some models may not be equipped with a roof mounted storage rack.

LP GAS SYSTEM

GENERAL INFORMATION

The liquid petroleum (LP) gas system in your recreational vehicle furnishes the fuel for cooking, heating, and hot water. LP gas can also be used as an alternate energy source for refrigeration. LP gas is a clean, efficient, safe form of energy when proper handling and safety precautions are observed. It enables you to enjoy a comfortable lifestyle where other forms of energy are not easily utilized.

The gas is stored under extreme pressure in the tank, with space in the tank to allow for expansion into vapor. This vapor is reduced in pressure by passing through a regulator. This reduction in pressure is a two step process which assures consistent pressure for use, regardless of outside temperatures, weather, or altitude.

Your LP system is designed to accept either propane or butane. However, since butane vaporizes at about 32°F, it can only be used in areas where you can be sure of higher temperatures. Propane vaporizes at approximately -40°F. There are blends of propane and butane available, which will vary in the temperature at which it vaporizes. When filling your tank, select an LP gas that has a boiling point about 40° lower than temperatures you expect to travel in. Talk to your dealer, or your local LP gas supplier about what you should be using.

LP Gas Tank and Gauges

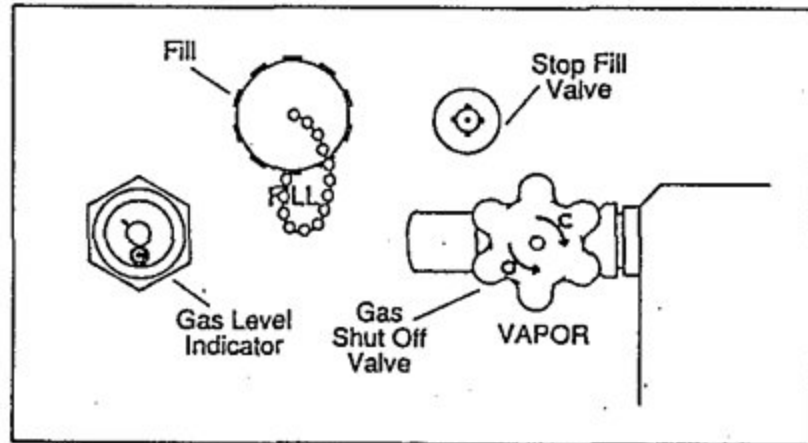

NOTE: Even though the tank is equipped with an automatic 80% shut-off which prevents overfilling beyond 80% tank capacity, it is a good idea to have the supplier monitor the 20% liquid level gauge, and stop the filling process if liquid does appear.

FILLING THE LP GAS TANK

1. Before entering the LP gas bulk plant or service station, make sure all pilot lights are extinguished. Shut off gas to all appliances by closing the LP gas main shut off valve.
2. Extinguish open flames and smoking materials.
3. Never remove the LP gas tank from the motorhome. Always drive the motorhome to the gas supplier to fill.
4. Have the supplier connect the fill nozzle to your tank fill connection.
5. Always remember to close the supply valve, and open the 20% liquid level valve.
6. Never use a wrench to close the service valve or 20% gauge. If when closing by hand, leaking occurs, have the valve repaired or replaced.
7. Drive at least one mile from the LP supplier before relighting pilot lights or appliances. This will allow any minimal leakage which occurred while filling the tank to dissipate. DO NOT light pilot lights if you continue to smell LP gas. Allow the recreational vehicle to ventilate for 30 minutes. If you still detect LP gas odor, have the source of the leak located and repaired.

Never use any other tank than the one furnished with your recreational vehicle. If the tank must be replaced, check with your dealer for correct tank specifications and replacement procedure.

WARNING: Make sure that the tank is not filled beyond the 80% liquid level. If the tank has been overfilled, make sure the LP supplier bleeds out the excess. Overfilling the LP gas container does not allow for the necessary 20% vapor expansion space that can result in uncontrolled gas flow which can cause fire or explosion.

WARNING: Make sure the tank service valve is accessible at all times. In an emergency, it may be necessary to shut off the valve quickly.

LP GAS REGULATOR

The regulator reduces the pressure of the LP gas vapor from the pressure in the tank, to the pressure required for use at the appliances. This reduction in pressure is performed by a two-stage regulator. Two regulators are used in the same body to reduce the pressure of the LP gas in the tank for use by the appliances in the recreational vehicle. The regulator seldom requires service, but it should always be protected from the elements and extremes of hot and cold.

The high pressure regulator (first stage) is used to reduce the pressure to approximately 10 to 13 PSI before sending it along to the low pressure regulator (second stage). This second stage regulator reduces the pressure further to 11 inches water column, or 6.35 ounces per square inch.

The two stage regulator does not have to work as hard since the second stage receives consistent pressure rather than inlet pressure which varies. The result is an efficient safer system that helps to eliminate problems such as freeze up and pilot outages.

The regulator has been preset by the manufacturer of the regulator, and adjustment should not be necessary. If adjustment should be required however, DO NOT attempt to adjust it yourself. Adjustment must be made with special equipment by a qualified LP gas service technician.

Have the regulator checked annually, or whenever you suspect a problem. The correct line pressure should be 6¼ oz., or 11 inches of water column.

Because air is required for proper operation of the regulator, it is very important that the regulator vent is kept clean and free of dirt and debris. This is why it is necessary to keep the vent facing downward and the regulator covered to protect it from contamination. A toothbrush can be used to clean the vent if it becomes clogged by foreign matter.

During cold weather, it is important to keep ice from forming in the regulator, which will shut off the flow of LP gas to your appliances. Have the supplier add an hydrous Methanol when filling your tank for use during cold weather.

Regulator freeze up can occur in any weather if there is moisture in the tank, or if the tank has been overfilled. Always use moisture-free LP gas, and make sure the tank has not been filled beyond 80% of capacity. If moisture has entered the tank, have the tank purged, or have an hydrous methanol added by an authorized LP supplier.

If you believe a regulator has been damaged or otherwise is not functioning, have it replaced by a competent serviceman.

⚠ WARNING: Never alter the positioning of the regulator. LP gas regulators must always be installed with the diaphragm vent facing downward. Also make sure to keep the regulator cover in place to minimize vent blockage which could result in excessive gas pressure causing fire or explosion. Do not rely upon being able to smell LP gas leaks, as the odor may not be sufficiently strong to detect.

REGULATOR FREEZE-UP

The term regulator freeze-up is a misleading one. Regulators and LP gas do not freeze. However, the moisture that can be contained in the gas will freeze as the gas expands and cools passing through the regulator. This freezing of the moisture in the gas can build up and partially or totally block the passage of the gas through the regulator. Freezing can also occur when outside temperatures are low enough to contribute to the freezing of the moisture in the gas.

The source of the moisture is varied. It can occur at the refinery or gas bulk plant, in the cars used to transport the gas, or even within your own LP tanks. Moisture in an LP tank can occur when a tank service valve is left open, allowing moist air to enter and become trapped.

A two-stage regulator helps to reduce the possibility of freeze-up because of its larger orifice size, and the fact that heat is transferred through the walls of two regulators instead of just one.

There are several steps that can be taken to inhibit or prevent this from happening:

1. Make sure that your LP tank is free of moisture before refilling.
2. DO NOT overfill the LP tank.
3. Make sure to keep the service valve on an empty tank closed.
4. If freezing has occurred, have your LP dealer purge the LP tank before refilling.
5. Add an hydrous methanol or other approved LP antifreeze or deicing agent to the LP tank.
6. Keep the regulator covered at all times.

LP Gas Regulator

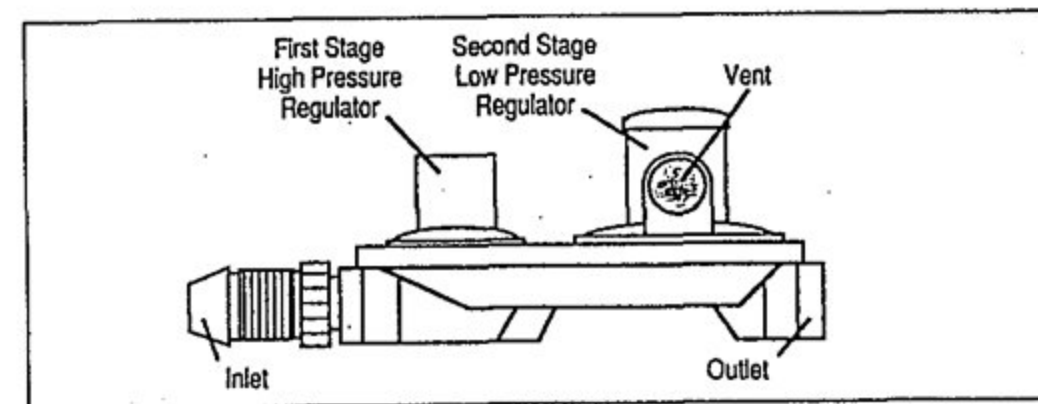

NOTE: If freeze-up does occur, shut off the LP gas at the tank. A frozen regulator may permit LP gas to flow at high pressure, resulting in leaks at appliances or in the lines. If freeze-up does occur, NEVER attempt to thaw with an open flame. A small light bulb can sometimes be useful to provide heat and aid the thawing process. Once thawed, be sure to take the proper steps to prevent a reoccurrence. Have the system checked by your LP supplier if freeze-up continues.

OTHER COLD WEATHER FACTORS

Remember that as outside temperatures drop, the BTU value of the LP gas is lessened, since the colder liquid LP in the tanks requires the heat from the surrounding air to vaporize. This lowering of BTU value can significantly affect the performance of the system. You can help insure proper performance by keeping your LP tanks as full as possible in cold weather, and reviewing the BTU/hr rating plates on LP appliances for proper LP management.

HOSES, PIPES, TUBES AND FITTINGS

The hoses, pipes, tubes, and fittings used in your LP system are designed to withstand pressures far exceeding those of the LP system. However, because environment and time can both contribute to the deterioration of these components, they must be inspected for wear at regular intervals. Be sure to inspect the hose before each season, and when having the tank refilled. Look for signs of deterioration such as cracks or loss of flexibility. When replacing the hose or other LP components, make sure to always replace them with components of the same type and rating (check with your dealer).

Fittings are used to connect the various system components to each other. The P.O.L. fitting at the end of the LP supply hose is made of brass so that pipe sealants are not necessary to prevent leaking. It also has a left-handed thread, which means that it is turned clockwise to remove, and counter-clockwise to tighten. The P.O.L. fitting has been designed to help restrict the flow of LP gas in the event of a regulator failure, or hose malfunction.

CHECKING THE LP GAS SYSTEM FOR LEAKS

Road vibration can loosen LP gas fittings. It is important to check your LP system for leaks at least every 5,000 miles, and whenever the tank is filled. It is also a good idea to have your entire LP gas system checked annually by a qualified LP gas service representative.

Use the following steps when checking the system for leaks:

1. Open all the windows and vents.
2. Open the gas tank service valve.
3. Use non-ammoniated, non-chlorinated soap solution, or an approved leak detection solution on all line connections (ammoniated soap solutions can cause cracking on copper or brass lines and fittings).
4. If a leak is detected, tighten the connection with two open end wrenches until the bubbling stops. DO NOT overtighten, or use excessive force. If the leak continues, contact your recreational vehicle dealer, or a qualified LP gas service representative.



WARNING: Never check for leaks with an open flame.

NOTE: The scent of LP gas (a garlic-like odor) is actually ethyl mercaptan, an additive that allows you to detect the presence of a leak, since LP gas is naturally odorless. Do not rely upon being able to detect the smell of the gas, as the odor may fade.

LP GAS LEAK DETECTION SYSTEM (C.C.I. Model 7330)

The following instructions are for the C.C.I. Model 7330 Pre-Tell 1 LP Gas Leak Detector. If your vehicle is equipped with a different brand, refer to the owner's manual for that specific information.

Model 7730 Gas Leak Detector

Power ON Indicator - Lights when detector is operating



HOW TO OPERATE

Your Pre-Tell 1 is powered at all times when the battery is connected. If your coach is equipped with a master cutoff switch, the detector will be turned off when this switch is turned OFF. When the detector is powered by connecting the battery or turning ON the master cutoff switch, the green indicator will light. After 60 seconds, the detector will begin monitoring the air in your coach for combustible vapors. The propane you use to cook, refrigerate, and heat is combustible. Should a leak occur, your Pre-Tell 1 will produce a pulsating alert sound when the gas reaches the detector. This alert will continue to sound until the gas has dissipated or until the reset button is pressed. **When the alert sounds, open all doors and major windows to air out the coach and turn the gas off at the tank. Do not reenter the coach until the alert stops sounding. If the alert sounds a second time after the gas is turned back on, leave the gas off and have a qualified LP Gas Dealer or RV Service Center make the necessary repairs.** The reset button only stops the alert from sounding for 60 seconds. **This device is intended for detection of LP Gas ONLY.**

HOW TO TEST

The detector must be operating for at least 60 seconds before it can be tested. Expose the detector to gas* and observe that the alert sounder will begin to alarm. The alert will continue to sound until:

1. The gas mixture at the detector returns to a safe level.
2. The reset button is pressed. *If the reset button is pressed, the detector cannot be retested for at least 60 seconds.*

This test procedure should be repeated every week or everytime the coach is taken on a trip, whichever occurs first.

Call (800) 521-5228
if you have any questions about
your C.C.I. LP Gas Detector.

*One method of simulating gas is to use a butane lighter (ie: BIC). **DO NOT** rotate the flint wheel. Just press on the gas release button and point the exit nozzle into the gas sensing area below the green light of the detector.

ABOUT YOUR LP GAS DETECTOR

Liquid Propane (LP) Gas is heavier than air and will settle to the lowest point which is generally the floor of your coach. The detector is also sensitive to other fumes such as hair spray of which most contain butane as the propellant. Butane, like propane, is heavier than air and will settle to the floor level where it will be detected. When this occurs, press the reset button to stop the alert sound for 60 seconds.

Other combustibles which will be detected include alcohol, liquor, deodorants, colognes, perfumes, wine, adhesives, lacquer, kerosene, gasoline, glues, most of all cleaning agents and the propellants of aerosol cans. Most are lighter than air in their vapor state and will only be detected when the coach is closed up. Glues and adhesives may exhaust hydrocarbon vapors for months after they are applied. They are easily activated by high temperatures. Close your coach up on a hot day and the chemicals used in its construction may be detected for months after the coach was manufactured.

Your gas detector is powered by your RV battery and/or your converter. It draws less current than drawn by one instrument panel lamp. Your detector will operate to detect gas until your battery is drained down to 10 volts. (Your low battery condition is 10.4 volts.) If the power source (battery and/or converter) is disconnected, or if the power is otherwise interrupted, the detector will not operate.

Your Pre-Tell 1 Gas Detector has a self check circuit which runs at all times when the detector is powered. In the event that the circuitry fails, a failure alarm will sound. It is a continuous series of short beep tones between long intervals and is distinctively different from the alert sound.

MOST COMMON CAUSES OF APPARENT MALFUNCTION

1. **New Coach Odor:** The glues and other materials used in manufacturing the coach produce vapors which may be detected when the coach is closed up on a warm day. *Air out the coach thoroughly.*
2. **Keeps Beeping:** The gas detector beeps about once every minute, — even when it is turned off. The problem is weak battery in the smoke detector which causes the smoke detector to produce short beeps which sound similar to the alert sound of the LP Gas Detector. This is a high pitch tone and bounces off the walls, making its location very hard to pinpoint. *Replace the battery in the smoke detector.*

3. **HAIR SPRAY TRIGGERS THE DETECTOR:** Most aerosol hair sprays use butane gas as the propellant. Butane, like propane, is heavier than air and will settle to the floor level where it will be detected. The detector is doing its job as butane is combustible.
4. **Other Gases:** Other gases which can cause the detector to respond with an alert include the vapors from any fuel, liquor, alcohol, deodorants, colognes, perfumes, wine, adhesives, lacquer, and most cleaning agents.
5. **Slow beep rate:** This could be the failure alarm and will occur if the battery is low or in the event that the circuitry fails. It is a continuous series of short beep tones between long intervals and is distinctively different from the alert sound.

After reviewing the above, if the problem still exists, call CCI for assistance.

NOTE: The Pre-Tell 1 enters a cleaning and initializing mode everytime it is powered. If turned off for less than 15 minutes, the Pre-Tell 1 may produce several short "chirps" within the first 80 seconds of operation. This is normal.

SERVICE

See your RV Dealer or a qualified LP Gas Service Center should service be required. If they are not familiar with this product, have them call CCI for assistance. If service is not available in your area, call CCI.

HOW THE DETECTOR IS CONNECTED:

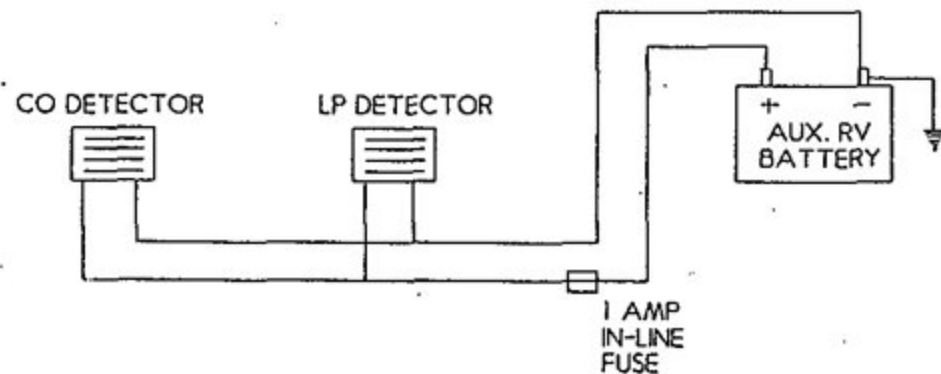

CO & LP DETECTOR WIRING

LP GAS SAFETY PRECAUTIONS

IF YOU SMELL GAS:

1. Extinguish any open flames, pilot lights and all smoking materials
2. DO NOT touch any electrical switches.
3. Shut off the gas supply at the tank valve(s) or gas supply connection
4. Open all doors and other ventilating openings. (DO NOT USE THE RANGE HOOD).
5. Leave the area until the odor clears.
6. Have the system checked and leakage source corrected before using again.

Be careful when doing any work or maintenance in the recreational vehicle, that you do not puncture a gas line with a nail, screw, or drill bit

A complete listing of the LP gas warning labels and decals used throughout the recreational vehicle can be found in the Introduction section of this manual. They are located in the recreational vehicle in locations where the potential for a dangerous situation is present. They have been installed not only because of the requirement to do so, but also as a constant reminder to occupants of the recreational vehicle to exercise proper caution when using or being around LP gas appliances and equipment. Make sure that you and your family understand and follow all of them. Never remove these warning labels and decals. If one should be lost, it should be replaced as soon as possible.

⚠ WARNING: DO NOT store LP gas containers inside the recreational vehicle. LP gas containers are equipped with safety devices which relieve excessive pressure by discharging gas to the atmosphere.

ELECTRICAL SYSTEM

GENERAL INFORMATION

The electrical power supply provided for the recreational vehicle is a dual system, operating with 110 volt AC and/or 12 volt DC.

The 110 volt power may be provided by either connecting the recreational vehicle to an outside power source when parked, or by use of a recreational vehicle generator. When the 110 volt system is operational, power also passes through a system converter, allowing the full use of all 12 volt functions in the recreational vehicle.

110 volt functions in the recreational vehicle include the refrigerator, ice maker, roof mounted air conditioner(s), TV and VCR, microwave oven, converter, outlets for 110 volt operated conveniences, and possibly some lights. The refrigerator also has the option of running on LP gas when 110 volt power is not available. All other electrical functions in the motorhome are supplied with 12 volt power.

When it is not possible to access 110 volt power, the 12 volt system functions can be supplied by the auxiliary batteries. The chassis battery is protected by a battery isolator controller to prevent discharge from excessive electrical consumption when the motorhome is not running.

The auxiliary batteries are recharged by the power converter when the recreational vehicle is attached to an outside 110 volt power source, or by the generator when it is running, and by the chassis alternator when the chassis engine is running.

CONNECTING TO AN OUTSIDE POWER SOURCE

A 30 amp shoreline power cord is provided to attach the recreational vehicle to a grounded power source. The electric utility service connection is located on the driver's side of the recreational vehicle near the rear, in various locations depending on the model that you have. The power cord is stored inside the electric utility service compartment. The electric utility service door has a slot with a cover that can be moved to the side, allowing the power cord to be used and the door to be closed and locked for security.

Never use a two wire extension cord, a cheater adapter with the ground pin removed, or put a lower amperage plug on your power cord in place of the molded plug.

Some models may be equipped with a 50 amp service instead of a 30 amp service.



WARNING: Connecting power cord to a non-grounded or improperly ground power source can result in a dangerous and possibly fatal electric shock. Because of the potential danger in failing to heed this warning, the recreational vehicle manufacturer cannot be responsible should damage, injury, or death result from failure to connect the power cord to a properly grounded power source.

BATTERIES

The chassis and/or auxiliary batteries of a motorhome may be located behind the front hood of the motorhome, or in some models, the Auxiliary Battery may be located under the dinette or under the sofa. This battery is mounted in a sealed battery box with removable lid. To access the battery, remove the screws and lift the top case off. When re-installing the cover make sure all connections are tight and the lid seals completely when secured to prevent battery fumes into interior of the coach.

It is important to make sure that batteries are kept charged. Take time to turn off all lights or other 12 volt conveniences when not in use. Connect the recreational vehicle to a 110 volt power supply when possible, instead of draining the batteries.

The charge condition of the batteries can be checked with the monitor panel. To check, press and hold monitor test switch while reading the charge level on the battery gauge. Charge levels indicated are divided into sections from weak through fully charged.

BATTERY MAINTENANCE

Battery maintenance is important. Checking the condition of a battery at regular intervals will help insure its proper operation. Here are some recommendations for checking and servicing batteries.

1. Keep the battery mounted securely. Vibration causes early failure of many batteries.
2. Check the electrolyte level of the auxiliary batteries at regular intervals. Keep each cell filled to just above the plates with distilled water. Once the plates have dried out, they cannot be reactivated, and the capacity of the battery is reduced in direct proportion to the area of plate surface that has become dry. This kind of damage can occur quickly; usually it can happen overnight. **NOTE:** The **THERMOIL** brand battery will have a thin layer of oil mixture on top of the plates to reduce gazing and eliminate corrosion. If the fluid level is low, simply add distilled water.
3. Keep the battery clean. Corroded terminals make poor contact and do not allow the chassis alternator or the converter to bring the battery up to full charge. Battery sulfation occurs when the battery has been standing in a discharged condition over a long period of time, or when the battery has been operated continually in a state of partial discharge. Use a baking soda solution to neutralize the acid accumulations on the battery top. Do not allow the soda solution to enter the battery. Make sure the vent caps are secure. Flush with water. Thoroughly dry all cables and terminals, reinstall, and use a plastic ignition spray to protect the terminals.
4. Check the outside condition of the battery. Look for cracks in the case or vent plugs. If the case is cracked, the battery must be replaced. If the vent plugs are cracked, they must be replaced.
5. Watch for overcharging. Three ways to spot overcharging are:
 - a. Active material on the vent cap (heavy deposit of black lead-like material on the underside of the vent cap).
 - b. Excessive use of water.
 - c. By testing voltage regulator output.
6. Make sure the battery hold downs and carrier are kept clean and free of corrosion.

When removing a battery, disconnect the ground battery clamp first. When installing a battery, always connect the grounded battery clamp last.

When a battery needs to be replaced, make sure to replace it with a battery of the same characteristics as the original equipment. Consult your dealer for advice on battery replacement.

BATTERY SAFETY

ALWAYS SHIELD YOUR EYES WHEN WORKING NEAR BATTERIES!

 **WARNING: BATTERIES CAN EXPLODE!** Do not smoke or expose any battery to electric sparks or flame. Batteries, when charging or discharging, generate hydrogen. Hydrogen and air is a very explosive mixture.

 **WARNING: Do not short across the battery terminals.** The spark could ignite the gases. Do not wear metal jewelry or a watch when working on a battery.

 **WARNING: Before doing ANY work on electrical system, disconnect battery cable and the 110 volt power cord. Do not reconnect the cables until all work has been completed. This will avoid the possibility of shorting or causing damage to electrical components or shock to the servicing person.**

 **WARNING: Battery electrolyte is a corrosive, poisonous, sulfuric acid. Avoid contact with skin, eyes, clothing, or any painted surface.**

AUTOMOTIVE 12 VOLT SYSTEM

Your motorhome chassis is equipped with an automotive 12 volt fuse panel located below the dash near the steering column. You should refer to the chassis owner's manual for details on these fuses.

The Class A motorhome also has a 12 volt fuse panel located on the firewall under the hood. These fuses protect the automotive features which are installed by **Four Winds International**. There is a complete breakdown on the various fuses printed on the backside of this fuse panel cover.

BATTERY ISOLATOR CONTROLLER (BIC) (Class A Motorhomes, Some Models)

When the motorhome engine is not running, the chassis and auxiliary batteries are kept separated from each other within the electrical system through the use of a battery isolating controller. The controller (BIC), prevents the auxiliary batteries from discharging the chassis battery when the motorhome is parked.

Some additional characteristics of the BIC system include:

1. Delays connecting the auxiliary batteries to the charging system for approximately 15 seconds, to allow the alternator time to reach full charging ability.
2. After this initial time delay, if the alternator has come up to full charging ability, the BIC will electrically connect the auxiliary and chassis batteries together for charging.
3. If the charging voltage drops below 12 volts for a period of 4 seconds due to low idle speed and/or excessive load, the BIC will disconnect the auxiliary batteries until the voltage returns to a level of 13.3 volts for about 10 seconds.
4. If the auxiliary batteries are above 11.5 volts and the chassis battery is below 9 volts, the BIC will automatically provide an emergency start from the auxiliary batteries.
5. In the event the automotive battery is fully discharged, the automatic emergency start feature will not function, it will be necessary to press and hold the start button located on the BIC control box inside the automotive fuse panel, or on the dash on some models.

BATTERY ISOLATOR (Class C Mini Motorhomes)

When the motorhome engine is not running, the chassis and auxiliary batteries are kept separated from each other within the electrical system through the use of a battery isolator solenoid. The isolator solenoid prevents the auxiliary from discharging the chassis battery when the motorhome is parked.

If power is lost to the interior from the auxiliary battery, check the breaker mounted on the side of the isolator solenoid under the hood.

NOTE: When operating 12V equipment from battery, reduce equipment in use to conserve battery. Gradual dimming of lights, and slowing of motors indicates low battery voltage.

POWER CONVERTER

The converter is used to switch 110V electricity from an external supply, or from the generator, to 12V electricity to power interior lights and 12V accessories. The converter requires no maintenance under normal circumstances.

If the converter does not have a 110V supply to convert to 12V, it automatically switches the batteries into the electrical circuit to power 12V functions. When reconnected to a 110V supply, it will again operate from this power source.

The converter will run warm and this is normal. If, however, it gets too hot, it will turn itself off. After it cools down, it will come back on. In most cases, when this happens it is because something has been put around or too near the converter preventing it from receiving adequate ventilation. Make sure not to put anything near the converter that could obstruct ventilation.

A slight hum during operation is also normal for the converter. If you have no 12 volt power and no hum, check to see if 110 volt power to the converter has been interrupted.

BATTERY CHARGING

The converter also operates as a battery charger when it is connected to a 110V power source. If the battery is below its full charge, the converter charger will begin operation at a rate that reflects the level of discharge. When the battery is again fully charged, the converter charger drops its charging level back to a maintenance level to keep the battery fully charged.

If for any reason you charge a battery with a source outside the recreational vehicle, make sure to follow the rules of battery maintenance and safety outlined in this section. Also observe these additional safety precautions related to battery charging:

1. Disconnect the battery from the recreational vehicle.
2. Check electrolyte before charging. Be sure each cell is properly filled with distilled water.
3. Make sure to use care when connecting and disconnecting the cables from chargers. A poor connection can cause an electrical arc, which can result in an explosion.
4. Remove the battery vent caps before charging, and make sure that the electrolyte does not splash out as a result of charging too quickly.
5. Check literature supplied by battery manufacturer, and follow warnings or cautions outlined.

BATTERY DISCONNECT SWITCH (Class A Motorhome)

The battery disconnect switch allows you to easily disconnect the auxiliary batteries from electrical circuits, preventing unwanted discharge during extended non-use. The switch is mounted on the dash left of the steer column.

There are three main uses of the battery disconnect:

1. Prevent unwanted discharging of batteries during extended periods of storage.
2. Prevent shorts or fire hazard while working on the 12 volt electrical system.
3. Prevent overcharging of batteries if the motorhome is attached to shoreline power for extended periods.

When activating, place the switch for the desired battery system in the ON position. This battery system will now be operational.

Place the switch in the OFF position to disconnect 12 volt circuits.

NOTE: It is not necessary or advisable to use battery disconnect switches as a substitute for turning off the various 12 volt applications available in the motorhome.

NOTE: If 12 volt functions are not working, be sure to check that the battery disconnect switch has been placed in the ON position.

GROUND FAULT CIRCUIT INTERRUPTER

The 110 volt outlet in the bath is equipped with a protective circuit interrupter. The ground fault circuit interrupter (GFCI), is designed to break the flow of current to the protected outlet when an imbalance of current is detected. Imbalances include electrical leakage in an appliance such as a shaver or hair dryer that have developed a weak spot in electrical insulation. The possibility of electrocution exists when using a faulty appliance, while at the same time being in contact with an electrical ground such as water, plumbing, or the earth.

If an imbalance is detected, the GFCI will trip and shut off power to the outlet. Even with GFCI protection, the electrical shock will still be felt, but to a lesser degree.

It also does not protect against short circuits or system overloads. Circuit breakers in the main panel which supply power to the circuit, will trip if either of these conditions exist.

The GFCI receptacle should be tested initially when the recreational vehicle is purchased, and at least monthly thereafter.

To test the circuit, use the following procedure:

1. Make sure power is on to the circuit. A test light or 1100 lamp will work.
2. Push the test button.
3. The red reset button should pop out.
4. All power should be interrupted to outlets protected by the GFCI.
5. Verify by plugging in a light at these outlets, and pushing in the reset button.

If the red reset button does not pop out after pushing the test button, or GFCI circuit continues to trip, or if the power is not interrupted to the test light, immediately turn off power at the circuit breaker panel and have a qualified electrician check it out.

 **WARNING:** Even with GFCI protection, persons with severe heart or other health problems may still be seriously affected by an electrical shock. The GFCI outlet is not a substitute for good electrical safety. It DOES NOT protect against contact of the hot and neutral wire at the same time.

NOTE: The GFCI does not protect any circuit other than the one to which it is connected.

CIRCUIT BREAKERS

The 110 volt system is protected by circuit breakers which automatically shut the circuit off if the circuit load is too heavy, or a short circuit occurs. If a circuit breaker has been tripped, do not reset the breaker until the cause of the problem is identified and corrected.

The generator also has one or two AC circuit breakers, and a DC fuse on the generator control panel. If an interruption in generator operations occurs, check to see if any of these have been tripped. Consult the manuals provided with the generator before attempting maintenance on the generator.

NOTE: Some electrical appliances may have their own circuit breakers. If there is an interruption in electrical service of an appliance, consult the manual for that appliance to determine what action to take.

12 VOLT FUSES

INTERIOR 12 VOLT SYSTEM — A 12V DC distribution panel is located next to the 110V circuit breakers. The panel contains circuits with replaceable fuses for protection of recreational vehicle 12V lines. If any line is loaded beyond the capacity of its fuse, the fuse will “blow”. A portion of the 12V load on the line must be turned off to reduce the total load on the line to a level below the capacity of the fuse. Replace the fuse with the same size fuse. DO NOT replace with a larger fuse than indicated.

If this reduction of load on the line does not stop the “blowing” of the replaceable fuses, there may be a “short” somewhere along the 12V line, or at a non-fused 12V component on the line. Check the 12V line and any components along the line. Locate the “short” and take necessary steps to repair it. If you cannot locate the problem, have a qualified electrician check it out.

It is a good idea to keep additional fuses on hand in the recreational vehicle. Replacement fuses are available at filling stations, hardware stores, or automotive supply stores. Remember that the replacement fuse must be the same amperage rating as the original.

AUTOMOTIVE 12 VOLT SYSTEM — The primary point to keep in mind about the unit’s 12-volt system is that the automotive chassis alternator supplies power to both the automotive systems as well as any auxiliary battery and directly to the RV living quarters while the vehicle’s motor is running.

Thus, of primary concern to you is the condition of the vehicle’s electrical system and especially the alternator.

The alternator compensates for electrical usage in the vehicle . . . the power drawn by the appliances, lights, fans and other 12-volt powered items as well as the charging of the automotive and auxiliary batteries.

If the alternator isn’t keeping pace with the draw on the unit’s electrical system, while driving down the road, it means you’re working in a negative mode: more power is being used than the unit is putting out.

This means that you are taking power out of the batteries. If you draw too much power from the batteries there may not be enough power left in the battery to start the RV or run any of the appliances when you stop for a break or for the night.

So, always keep an eagle eye on the alternator’s output. Also check the monitor panel frequently to see that the auxiliary battery is up to full charge.

The alternator will charge at a higher rate right after the vehicle’s been started, replacing the power used to start the vehicle, but the charging should quickly go back to “normal” and hold its own even when you turn on lights or appliances.

When stopped at a campsite that allows you use of the shoreline, the 120-volt electrical system will recharge your auxiliary battery.

Some monitor panels will show a battery as being fully charged unless there is a draw on its system.

When checking auxiliary battery condition, turn on several interior lights to place a load on the battery. Under heavy usage in warm weather, check the fluid level of those batteries that require attention to fluids quite often. Low battery fluid level is very harmful to the battery’s longevity.

If the alternator shows a discharge while the motor is running, turn off appliances and lights to see if a charge comes on or if the alternator indicates “neutral”. Then apply a drain on the system to see if a discharge returns.

If a discharge persists, contact your dealer.

Sometimes, especially in hot weather, the alternator may show a marginal condition while idling with the air conditioner in use. Note if the system goes more to normal while the vehicle is at speed. If the marginal condition continues and you are in a constant stop-and-go traffic situation, such as in a populated area, it may be a benefit to turn off the air conditioner.

GENERATOR

IMPORTANT: MAKE SURE TO READ AND UNDERSTAND THE GENERATOR OWNER’S MANUAL BEFORE OPERATING THE GENERATOR. Observe all warnings and cautions, as well as all recommended maintenance schedules and procedures.

To utilize the generator, it is necessary on some models to plug the shoreline 30 amp plug into the outlet provided in the shoreline storage compartment. When outside 110 volt service is available, simply unplug the shoreline from this outlet and plug it into the exterior outlet as outlined earlier. On some models when the generator is accessed, electrical connection is automatically switched over to the generator through a transfer switch.

For Gasoline Engines: The generator is fueled from the same tank which supplies fuel for the chassis engine. The tube which supplies the fuel for the generator is placed higher in the tank than the chassis engine fuel supply tube. This prevents the generator from draining all fuel from the tank. On diesel powered motorhomes, the generator is fueled by LP gas from the LP gas tank.

There may be three locations from which to start the generator. One is at the control panel on the generator itself, while the other is located on the kitchen sink base inside the recreational vehicle. Some models also have a remote switch on the dash.

GENERATOR SAFETY

There are several warnings and precautions that should be observed when using the generator. **MAKE SURE** to read all warnings and cautions in the generator operator's manual before operating or attempting repairs on the generator.

1. Never store anything in generator compartment. Always keep compartment clean and dry.
2. Review the safety precautions for fuel and exhaust fumes elsewhere in this manual.
3. **DO NOT** operate the generator while sleeping. You would not be aware of exhaust entering the recreational vehicle, or alert to symptoms of carbon monoxide poisoning.
4. **DO NOT** operate the generator when the recreational vehicle is parked in high grass or brush. Heat from the exhaust could cause a fire in dry conditions.
5. Never operate your chassis or generator engine, or the engine of any vehicle, longer than necessary when the vehicle is parked.
6. **DO NOT** simultaneously operate generator and a ventilator which could result in the entry of exhaust gas. When exhaust ventilators are used, we recommend that a window on the opposite side of the unit "up wind" of exhaust gases be opened to provide cross ventilation.

7. When parked, orient the vehicle so that the wind will carry the exhaust away from the vehicle. **DO NOT** open nearby windows, ventilators, or doors into the passenger compartment, particularly those which can be "down wind", even part of the time.
8. **DO NOT** operate the generator when parked, so that vegetation, snow, buildings, vehicles, or any other object could deflect the exhaust under or into the vehicle.
9. **DO NOT** touch the generator when running, or immediately after shutting off. Heat from the generator can cause burns. Allow the generator to cool before attempting maintenance or service.

WATER AND DRAINAGE

GENERAL INFORMATION

Your new recreational vehicle plumbing system has the dual ability to be self contained with onboard storage, or use facilities provided by an external pressurized source. In either case, the components of the system operate like those in your home. Components of the plumbing system consist of strong, lightweight, corrosion resistant materials that provide long life, and easy cleaning. By following the instructions outlined here, you can expect efficient operation with a minimum of maintenance.

Recreational vehicle plumbing can be divided into two separate systems. The fresh water system consists of those items which are used to deliver water for your use, while the waste water system is made up of the drains and tanks which store and remove water that has been used.

FRESH WATER SYSTEM

Fresh water is provided from an external pressurized source, or from the fresh water storage tank.

EXTERNAL HOOKUP

Water provided from outside the recreational vehicle is pressurized by the system from which it is delivered. When you connect your recreational vehicle to an outside source, the fresh water tank and the water pump are kept separate from the remainder of the system by in-line check valves.

To attach the recreational vehicle to an outside source of water:

1. Remove the cap from the fresh water inlet on the side of the recreational vehicle.
2. Attach one end of the fresh water hose to the outside source of water.
3. Connect the other end of the hose to the recreational vehicle city water inlet.
4. Turn the outside source of water on. Open the various faucets in the recreational vehicle gradually to clear the air from the lines. Close the faucets when the water flows freely.

NOTE: Do not turn the water pump on when using water from an external supply.

To disconnect from the outside source of supply:

1. Shut off the outside source of supply.
2. Disconnect the hose from the supply valve and the recreational vehicle inlet.
3. Re-reel the hose and store.
4. Reinstall the cap on the recreational vehicle inlet.

FRESH WATER TANK

When an outside source of water is unavailable, water can be drawn from the fresh water storage tank for use in the recreational vehicle. The tank is filled through a gravity controlled water fill spout on the side of the recreational vehicle.

To fill the fresh water tank, proceed as follows:

1. Remove the water fill spout cap.
2. Water can now be added directly to the tank through the fill spout by use of a known clean hose or bucket, used only for this purpose.
3. When the tank is filled, replace the water fill spout cap.

NOTE: Always fill the tank with clean drinkable water from a known safe source. Make sure to close the fill spout when the tank is filled. Also, always fill the system with a hose that you know is clean, and is used only for this purpose.

When traveling, you may want to drain the tank, or keep the quantity of water in it to a minimum. This reduces the total weight of the recreational vehicle for travel. Make sure when draining the tank, that the water pump has been turned off. The fresh water tank drain valve is located below and near the fresh water fill spout. Water in the tank can be drained by turning the drain cock perpendicular to the recreational vehicle body. To close the valve, turn the lever parallel to the recreational vehicle body.

NOTE: When trying to drain entire onboard fresh water system, make sure to open faucets, water heater drain, and system low point drains to remove all fresh water from the system.

WATER PUMP

When using water from the fresh water tank, the system must be pressurized. A self-priming 12V DC pump is provided to handle this function. A pump on-off switch is located on the monitor panel.

When initially starting up the self contained water system, follow this procedure:

1. Make sure the tank is filled with water.
2. Open all the faucets in the recreational vehicle, both hot and cold.
3. Place the pump control switch in the ON position.
4. Allow time for the hot water tank to fill. Shut off each faucet as the flow becomes steady and free of air. When the last faucet is shut off, the pump should also shut off.
5. The system is now ready for use.

NOTE: When filling the system, you may want to add additional water to the tank to replace the water used when filling the hot water tank and water lines.

The self contained water system is a demand system. This means that the water pump will run whenever there is a need for water. If the pump runs while all faucets are closed, there may be a leak in the system. Ask your dealer for assistance.

Typical Fresh Water System

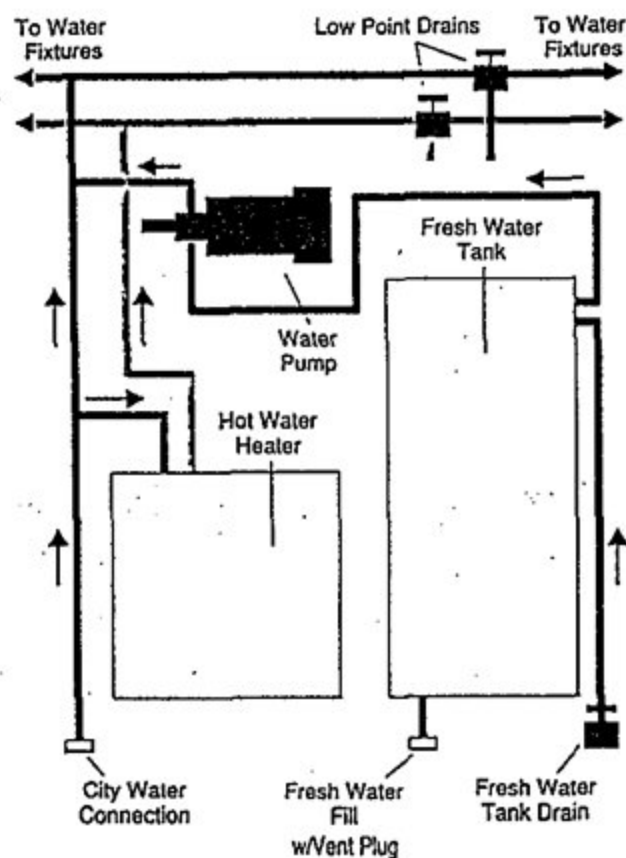

SANITIZING THE FRESH WATER SYSTEM

Sanitize the system before initial use, after extended periods of non-use, at least once a year during continuous use, and whenever there is suspicion that the system has been contaminated.

To sanitize the system, use the following procedure:

1. Prepare a chlorine solution using a gallon of water and $\frac{1}{4}$ cup of liquid household bleach (5% sodium hypochlorinate solution). Use one gallon of solution for each 15 gallons of tank capacity.
2. With tank empty, and all faucets and drains closed, pour the solution into fresh water tank.
3. Complete filling the tank with fresh water.
4. Switch on the water pump. Open all faucets one at a time until all air is purged, and the water flows freely.
5. Again add fresh water to the tank until the water level reaches the fill spout.
6. Allow the system to stand undisturbed for a few hours (at least three).
7. Drain the system by opening all faucets, and the fresh water tank drain valve, while flushing the system with water of drinking quality.
8. Continue flushing the system, allowing the water to flow for several minutes.
9. Close the tank drain valve and faucets. Refill the system with water of known drinking quality.

NOTE: A slight chlorine taste may linger. If this is objectionable, mix a solution of 1 quart Vinegar to 5 gallons of water and add to the tank. Let stand for 3 hours and flush.

MONITOR PANEL

The monitor panel allows you to quickly check the levels in the fresh water and waste water tanks. Electrical sensors at various points on the tanks send signals to the monitor panel. To check fluid levels, press and hold the test switch designated for the tanks, and read the level indicators on the panel. The indicator is proportioned in quarters with each light being lit up to the level that the tank contains.

Sometimes, residue on the sides of a tank, or water with a low mineral content will give a false reading. Check the levels occasionally when you are sure of a tank's contents to double check the accuracy of the monitor panel.

NOTE: Other monitor panel functions such as checking the battery charge level are discussed elsewhere in this manual (see Index).

WASTE WATER SYSTEM

The waste water system in your recreational vehicle can be described as two separate systems. A gray water system that consists of the drain lines and holding tank for waste water from the sinks and tub, and a black water system which includes the holding tank and drain for toilet wastes. In some cases the bathroom lavatory may drain into the black tank. Each system is self-contained, and allows disposal of waste water at designated dump stations at your convenience.

Components of the gray water system have drain traps, and both tanks are vented to equalize air pressure and disperse odors caused by drain water and wastes outside. Sometimes, the rocking movement of the recreational vehicle while driving may empty the drain traps of their water, and allow the odors of the gray water tank to come into the coach. Residue in the drain water lines can also produce odors. To combat gray water holding tank odors, an approved deodorizing agent should be used. An agent that dissolves grease and fats and contains a detergent will help keep tank and drain lines clean and free-flowing.

Typical Waste Water System

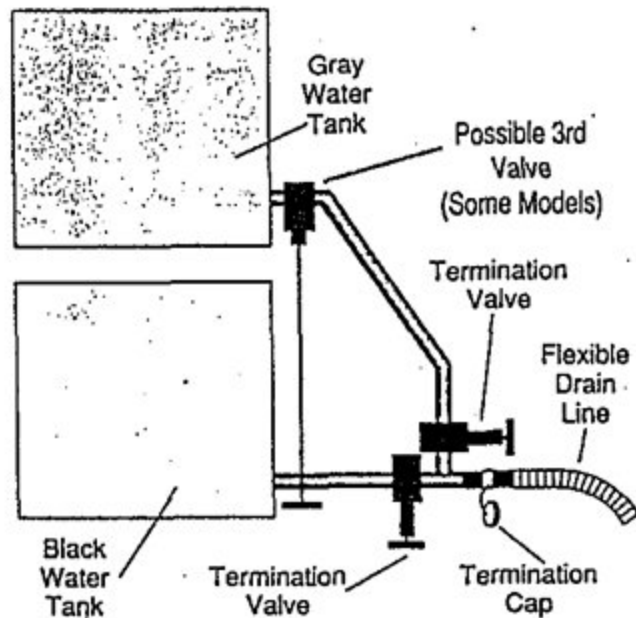

HOLDING TANKS

Both holding tanks are approximately located beneath the bathroom area. Drain valves and drain hose storage are located on the driver's side.

Each tank has a separate drain line and dump valve, which permits dumping tanks individually or together. Each tank should be emptied often at a dump station designated for this purpose. Most national, state, and private campgrounds have dumping facilities. Many have hookups on the campsite, while some have portable dump collectors. Many service stations, particularly along interstate highways, also have these facilities. Many campground directories list dumping station locations across the nation.

If possible, dump holding tanks before a trip, to reduce the gross vehicle weight. Enough water should be kept in the black water tank to cover the bottom, to prevent hardening of any residue that may remain.

Do not dump black water tank until it is $\frac{3}{4}$ full. This practice makes sure that enough water is in tank to flush all wastes into sewer lines. If necessary, fill tank to the $\frac{3}{4}$ mark with additional water before draining.

Never put anything in the holding tanks other than normal drain water, wastes, and biodegradable products. Paper wrappers, gum, cigarettes, etc., no matter how small they may be, should never be placed into either the gray or black tanks.

NOTE: It is important to note that harmful and toxic materials can accumulate if the holding tanks are not regularly drained and thoroughly rinsed. It is also important to use holding tank deodorizing and cleaning agents in the waste water tanks to reduce odors and keep the lines open and free-flowing.

To Empty the Holding Tanks:

1. Remove the sewer drain hose from its storage compartment on the side of the coach.
2. Remove the cap from the recreational vehicle sewage drain, and connect the drain hose to it.
3. Attach the other end of the flexible drain line to the dump station inlet. Make sure both ends of the flexible drain line are securely attached.
4. Drain the black water tank first, by pulling the termination valve handle toward you. Make sure to allow sufficient time for the tank to completely drain, then rinse the tank with several gallons of water by depressing the stool pedal. Close the valve on the stool and let it fill before releasing the tank. This creates additional force to flush the tank more completely.

5. Drain the gray water tank by pulling the termination valve handle toward you. Draining the gray water tank last, with its soapy water helps to further rinse the drain and flexible hose.
6. When tanks are emptied, close termination valves by pushing handles back to closed positions.
7. Remove flexible drain hose and wash it thoroughly with clean water. Remove the other end from the dump station inlet, and replace it in its storage compartment. Secure the sewer hose storage cover, and replace the caps on both the recreational vehicle outlet and dump station inlet.

The following guidelines will help to ensure trouble free operation:

1. Never put anything in black water tank other than toilet paper especially for RV systems.
2. Do not put automotive antifreeze, household toilet cleaners or drain cleaners, or any solid material into the waste water system.
3. Always use chemicals in the black water system that are made especially for this purpose.
4. When cleaning components of waste water system, use cleaners made for RV systems.
5. Always keep the drain cap in place, and termination valves closed.
6. After every third time the holding tanks are emptied, fill and flush both tanks with clean fresh water a couple of times to keep them clear and clean.

NOTE: If connecting to a campsite sewer inlet, DO NOT open termination valves until tanks are $\frac{3}{4}$ full. DO NOT keep black water valve open while parked. Wastes are NOT flushed directly into sewer system. Only liquid waste is drained, therefore, water must accumulate, and chemicals in tank need time to break down solids before they can be released. If draining gray water tank directly into sewer inlet while parked, make sure to close termination valve for a period of time before leaving, allowing some water to accumulate in tank to use for flushing drain line and flexible hose.

NOTE: Always remember to clean up the dumpsite before leaving. NEVER empty your holding tanks directly on the ground, a roadway, river or stream. DO NOT POLLUTE.

FAUCETS

The faucets in your recreational vehicle have been designed to be economically practical faucets that can be both beautiful and durable. The one-piece plated faucet shield is put through extensive treatments to produce a surface finish which will maintain its lustrous beauty throughout many years of use.

The patented design eliminates washer wear — the common cause of leaking. Should your faucet develop a leak it is most likely caused by debris in the water line causing improper seating of the stem tip; or as a result of the handle stop being misaligned.

Refer to the faucet owner's manual supplied with your recreational vehicle for specific maintenance and service instructions and an 800 phone number for service.

TOILET

The marine style toilet installed in your recreational vehicle is connected to the pressurized fresh water system. The toilet is equipped with two operating levers located on the back right side of the toilet when facing it. To flush, pull the black lever forward (clockwise) until rinse clears the bowl. Be sure to release the lever slowly. Movement of the flush lever opens the waste valve and allows the water to pass into the holding tank. Water fill is activated simultaneously with the black flush lever. The lever should be held open for several seconds to allow adequate flush water coverage of the bowl. The water fill lever (white), can be operated independently of the flush lever if more than the normal 2" automatic bowl refill water is desired.

Unnecessary frequent flushing of the stool will quickly deplete your fresh water supply and fill your holding tank. If the black water tank becomes full, you will no longer be able to flush the stool until the tank can be drained.

Follow the toilet manufacturer's recommendations supplied with the toilet for cleaning and maintenance. If you have a toilet that differs from the description given here, make sure to follow the manufacturer's advice for operation.

Toilet Operation

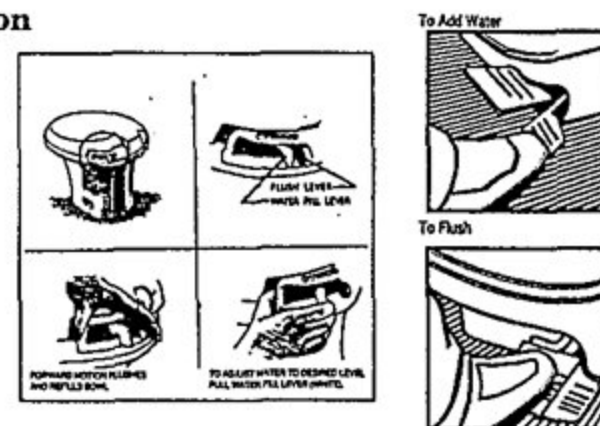

WATER SYSTEM WINTERIZATION

If you intend to store your recreational vehicle through periods of sub-freezing weather in an unheated environment, it will be necessary to winterize the water system. Damage to water system components will result if proper winterization steps are not taken.

1. Level the unit for good system drainage.
2. Drain the waste water tanks as previously outlined.
3. Turn the water pump switch off.
4. Open all faucets, and the water heater drain.
5. Open low point drains on the water lines.
6. Drain the fresh water tank.
7. Blow the water lines out using compressed air (through the city water hook up not to exceed 60 PSI).
8. When all lines are drained, close water tank valve, water heater drain, and low point drains on water lines.
9. Fill the fresh water tank with a non-toxic antifreeze solution per the product directions.
10. Turn on the water pump, and allow the winterizing solution to circulate and fill the system.
11. Close each faucet as solution flows freely from it. This also includes the water line to toilet.
12. Turn off the water pump.

Antifreeze solutions include the following:

1. 60% Glycerol, by weight in water, UNDILUTED.
2. 22% Magnesium Chloride, by weight in water, UNDILUTED.
3. Any recommended portable RV plastic pipe antifreeze.

Before using the system again in warmer weather, completely flush the system with water, flush the toilet, and sanitize the entire fresh water system. When using the recreational vehicle during cold weather, and water in a tank or drain line should happen to freeze, you should take immediate steps to thaw it before damage to the system occurs. DO NOT continue to use water system components if such a condition exists. If damage has occurred, make sure to have it repaired before using again.

WATER SYSTEM MAINTENANCE AND TROUBLESHOOTING

As with any mechanical system, your plumbing is subject to the development of problems. Most of these problems can be greatly reduced if not altogether eliminated by following a schedule of planned inspections and maintenance. Neglect of proper maintenance procedures is the usual cause of most water system problems.

Road vibrations and shocks, as well as excessive pressure from some city water sources are the main physical causes of water system damage. It is important to inspect all plumbing joints and fittings often for cracks and leaks. Water leaking from a plumbing joint can cause considerable damage if left unchecked.

A leak somewhere in the fresh water system should be suspected whenever the pump is running and all faucets and valves are closed. When the leaking fitting has been identified, attempt to stop the leak by tightening. DO NOT overtighten. Plastic fittings rarely need to be tightened with a wrench. If these fittings leak after tightening by hand, disconnect the fitting and check for dirt, scale, or other foreign substances which may be causing the leak. Clean the fitting thoroughly and reinstall. If leaking persists, shut off the water supply until the fitting can be properly replaced. Check with your dealer for correct method of replacement, and replacement parts.

Proper winterization procedures of plumbing systems will normally be all that is necessary to prevent the damage caused by freezing. Freezing damage can harm any component of the system, including the water tanks, toilet, pump, and all piping. Be sure to follow the winterization procedures outlined in this manual. Also be sure to discuss any additional precautions that should be taken to winterize your trailer's plumbing system with your dealer. Local climates vary; and winter maintenance needs may be effected.

Be sure to read the literature supplied with plumbing components, such as the pump, for troubleshooting tips. Also remember that it is possible for an electrical problem to cause water system problems. Lack of power to the pump can be caused by a variety of reasons. If you are unsure of how to locate and/or repair a plumbing problem, it is best to have your dealer or a qualified plumber handle the job.

APPLIANCES

GENERAL INFORMATION

The following instructions are general in nature and may vary from the appliances in your recreational vehicle. Each appliance should have an individual owner's manual and operating instructions supplied with the recreational vehicle. Please refer to these manuals for more detailed instructions and information on the operation of your particular appliance.

The various appliances in your recreational vehicle will provide home-like convenience while traveling. They have been designed and tested by their manufacturers for maximum service in a recreational vehicle application.

Each appliance in your recreational vehicle is warranted by their respective manufacturer. Be aware that constant improvement in design of the recreational vehicle may mean that an appliance in your recreational vehicle may not yet be covered in this manual. It is extremely important that you review all the literature provided in the manufacturer's information package provided with your recreational vehicle. Fill out and mail any warranty registration cards required by the appliance manufacturer at this time. Be sure to have your dealer go over the operation of the appliances with you, and report any shortages of literature you may have at that time.

It is important that you carefully read all the manufacturer's information provided regarding both operation and maintenance of the appliances. Pay close attention to all safety precautions given, and make sure to follow them. If the instructions for operation of any appliance differ from the instructions outlined in this manual, make sure to use the information provided with the appliance.

Be sure to keep all literature, including this manual with the recreational vehicle for easy reference. If service on any appliance is required, contact your dealer, or an authorized service representative of the appliance manufacturer. Most appliance manufacturers have toll free service telephone numbers for your convenience.

REFRIGERATOR

MAKE SURE to read the owner's manual furnished with the refrigerator for complete instructions regarding the operation and maintenance of your refrigerator.

The refrigerator may be powered by either 110 volt electric, or LP gas. A 12 volt supply is also needed for the electronic control functions. Controls for operation are located below the refrigerator door. Controls include a mode selector switch to choose gas or electric operation, or shut the unit off, and a thermostat to set the temperature from a cold to coldest setting. Indicators on the control panel confirm the mode in which the refrigerator is operating, as well as letting you know if the flame has been lost during LP gas operation.

The thermostat should be set on the coldest setting during start up and initial operation. After the unit has run for awhile allowing the refrigerator to cool, the thermostat should be lowered to the desired temperature range, which is usually approximately mid-setting.

The freezer compartment is not designed for the quick freezing of food, but to retain frozen food in that state. Foods purchased for storage in the freezer compartment should be frozen when purchased to reduce the load on the refrigerator system. Ice will be made more rapidly if the thermostat is set at its highest position.

NOTE: It is important to make sure that refrigerator is level before attempting to start. Once started, the movement encountered during driving should not affect operation. However, when the recreational vehicle is parked, the sensitivity of the refrigerator to be level should be remembered.

NOTE: Never fill your refrigerator with large amounts of warm food or liquid. This will lower the temperature and will take a long period of time for the refrigerator to recover.

WATER HEATER

The water heater is automatically filled from the fresh water system, or when the recreational vehicle is connected to an outside water system. Make sure the water heater has been filled before attempting to light it or heat it by electricity.

The water heater is equipped with three inline shut-off valves to aid in winterizing. These valves must be in the proper position to allow water to flow in and out of the water heater.

Read all the literature provided with your water heater before using it. Pay particular attention to any cautions or warnings associated with its use.

When operating, it will provide hot water to the kitchen and bath. There are various styles of water heaters available, including electronic ignition models. Refer to the water heater manufacturer's owner's manual for specific operating instructions.

RANGE

MAKE SURE to read the owner's manual provided by the range manufacturer carefully **BEFORE** using the range, and follow all precautions outlined. Never leave the range unattended when lit.

LIGHTING THE RANGE BURNERS

The range in your recreational vehicle may be a four burner style or three burner style. There may be no pilot light under the range top that must be lit before the top burners can be operated. It is necessary however to make sure that the main LP gas valve on the LP tank is turned on.

 **WARNING: DO NOT** light range if you detect the odor of LP gas before attempting to light it. Follow all safety procedures associated with use of an LP gas appliance and system. **DO NOT** use the range to heat your recreational vehicle. The open flames of the burners can consume the oxygen available in unit.

RANGE HOOD

The range hood exhausts the air and cooking odors from the kitchen area, as well as provides light for cooking and countertop activities. The exhaust vent on the outside of the recreational vehicle opens automatically when exhaust fan control is activated.

The exhaust filter screen and fan should be cleaned occasionally to remove accumulated dirt and grease. Clean the filter screen in a hot detergent solution.

Some models may not be equipped with an exterior venting range hood, in this case the exhaust is filtered through the filter screen and vented into the interior.

 **WARNING: Never** turn exhaust fan on with filter screen removed. The exposed fan blades pose an injury threat, and dirt and grease deposits which are normally trapped by filter are free to build up in range hood exhaust duct, creating a fire hazard.

MICROWAVE OVEN

The microwave oven is an optional appliance that can be used for the convenient and fast defrosting, cooking, or simmering of foods. The oven is controlled by an auto-touch panel which allows it to be programmed for all of its various functions. Make sure to read the literature provided with the microwave oven for detailed information regarding its operation. Be especially sure to follow all precautions outlined in the manufacturer's literature.

Make sure that the oven turntable (when applicable) is in place before operating, and that the movement of the turntable is not restricted. It is important that you select the proper power level for the various foods and operations you will be using. Refer to the operating instructions and the cookbook provided with the microwave for the settings best suited for the food category you are cooking.

The oven should not be adjusted or repaired by anyone except properly qualified service personnel. **DO NOT** operate the oven if it has been damaged.

ROOF AIR CONDITIONER

The recreational vehicle can be equipped with an optional roof mounted air conditioner. It operates on 110 volt power, and is located in the living/dining area of the recreational vehicle and also in the bedroom area of some models. The recreational vehicle may come factory equipped with the wiring and necessary bracing for the insertion of an air conditioner, even if it is purchased without the air conditioner installed at the factory.

Refer to the manufacturer's owner's manual for complete operating and service instructions.

Efficiency when using the air conditioning can be increased by closing all windows and curtains, and parking the recreational vehicle in the shade. Air conditioning consumes a large portion of the electric power available in the recreational vehicle, so efficient operation can be an important consideration. Even though your recreational vehicle is equipped with 30 amp capabilities, be aware that some campgrounds may offer less than 30 amp service. Check what amperage is available before utilizing excessive power that may create a fire hazard or trip breakers in either the recreational vehicle, or the outside power source.

NOTE: Always turn off air conditioner (and all electrical appliances) before disconnecting the motorhome from its 110V power source.

NOTE: If you cover the outside portion of your air conditioner during periods of storage, make sure to remove protective cover before reusing.

AIR CONDITIONER SELECTION SWITCHES (30 Amp Service Only) (Some Models)

Some motorhomes may be equipped with two roof mounted air conditioners. One for the front portion of the unit, and one for the rear. This allows you to cool a specific area of the motorhome as needed. However, 30 amp service from the shoreline connection will not support the current draw required to utilize two roof air conditioners at the same time. When using 110V power from the shoreline connection, it is necessary to select one or the other of the two units. It is possible however, to utilize both air conditioning units simultaneously with the 110V power supplied by the generator.

Some models are not equipped with this switch.

To make the proper selection of air conditioning units, based on the source of 110V power, a selection switch panel is mounted in the bedroom. The switch panel consists of one 3-position switch that controls both the power to the units as well as proper selection of the source of power.

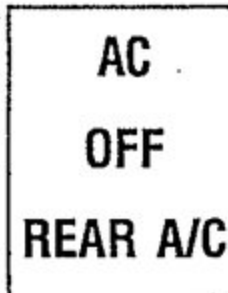

Positioning of the switch for various air conditioning combinations when plugged into a shore power source are as follows:

Switch Centered	No power to either A/C
Switch Down	Rear A/C only, on Shore Power
Switch Up	Front A/C only on shore line power and Rear A/C on generator power

NOTE: No power can reach either air conditioning unit if the switch is in the OFF position.

Make sure that when using both air conditioners at the same time from generator power, that you turn on one air conditioner, and allow it to run for a few minutes before turning on the second unit. This prevents overloading the circuits with a dual power surge when the units are started.

Remember that when running both the air conditioners from the generator; utilizing additional 110 volt appliances may cause the generator circuit breaker to trip. Turn both units off before resetting the breaker. If necessary, choose the unit that will be most effective for cooling the area of the motorhome you will be using.)

FURNACE

Your recreational vehicle is equipped with a central heating system that is made up of a furnace, thermostat, and ducting to carry the heat throughout the recreational vehicle. The furnace may be a self-igniting (electronic ignition) model that does not require the manual lighting of a pilot light for operation.

The furnace is vented to the outside for both intake and exhaust functions. Never store anything in the furnace compartment of the recreational vehicle, or block the exhaust vents on the outside of the recreational vehicle. Take care to keep heat duct registers open and free of obstruction.

Have the entire heating system inspected annually by a qualified service agency to ensure safe and efficient operation. If you suspect a problem at any time with the system, have it taken care of immediately.

Refer to the furnace manufacturer's owner's manual for specific operating instruction.

NOTE: Make sure to read all information supplied by the furnace manufacturer, paying particular attention to any warnings or cautions associated with its use.



WARNING: Never operate the furnace if you smell gas.

AUDIO AND VIDEO

There are various audio and video features available for use in the recreational vehicle. These features include a stereo, television(s), VCR, and a VCP. Because of the complexity of instruction for these different features, you should refer to the instruction manuals provided with each of them for complete operating information.

TV ANTENNA

The optional roof mounted antenna control is located in the ceiling of the lounge/kitchen area. The antenna can only be used when the recreational vehicle is parked.

To raise the antenna, crank the handle in the up direction as indicated by the arrow on the large control knob. Continue to rotate the handle until you feel resistance (about 13 turns). DO NOT force the handle beyond the point that resistance is felt. Make sure to check your parking location for obstructions before raising the antenna. Also make sure the power boost switch is in the ON position.

When the antenna is up, fine tune the signal by grasping the large rotating knob, pulling it slightly down, and turning it until the clearest picture and sound are available.

To lower the antenna, rotate it with the large control knob until the pointer on the control knob lines up with the pointer on the ceiling plate. The antenna can now be lowered by cranking the handle in the down direction. Continue to rotate the handle until you feel resistance (about 13 turns).

To make sure the antenna is working properly, tune the TV receiver to the nearest station and rotate the antenna for the best picture and sound. Next turn off the switch on the power booster.

Make sure to turn off the power booster when not in use. The booster can drain the battery if allowed to remain continuously activated. There is a red indicator light on the power booster that is illuminated when it is on.

NOTE: It is a good idea to visually check the position of the antenna after raising or lowering. Make sure when lowered, that the antenna lines up parallel to the side of the recreational vehicle.

Raising the Antenna

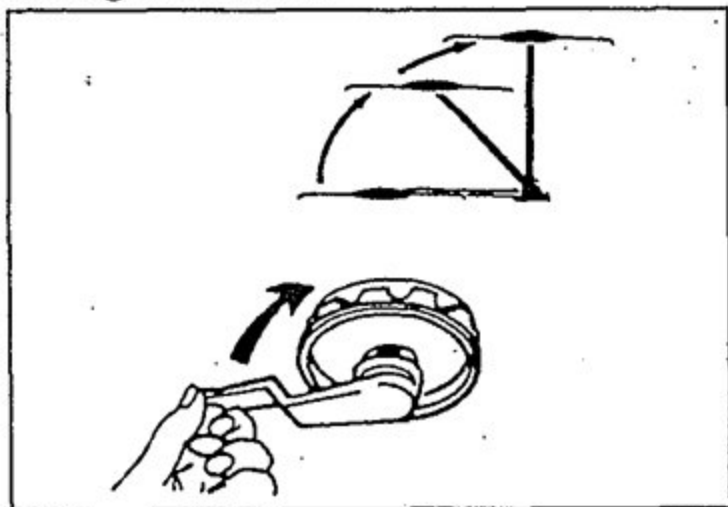

Fine Tuning the Signal

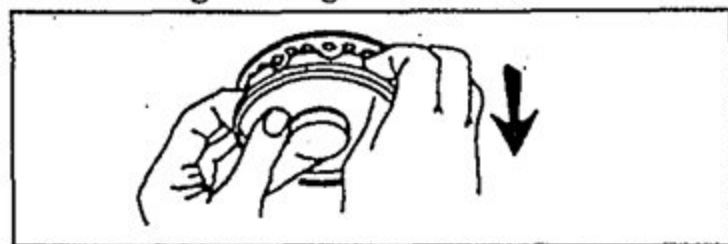

⚠ WARNING:
Do not connect any high current devices to antenna power boost circuit. The maximum current rating of circuit is 8 amps at 12V DC.

⚠ WARNING:
Always lower the antenna before moving the recreational vehicle. Wind and low obstacles can severely damage or destroy the antenna if it is raised while traveling.

CARE AND MAINTENANCE

GENERAL INFORMATION

Periodic maintenance and cleaning of your recreational vehicle is necessary to retain the dependability, safety, and appearance that will provide you with many miles of trouble free operation, as well as protecting your investment.

Make sure to read and follow all the maintenance tips and schedules that appear not only in this manual, but also in the manuals provided by the chassis manufacturer and various component manufacturers. Keep good records of maintenance functions performed, and make sure to perform all owner obligations as may be required by the chassis manufacturer to keep your warranty in force.

It is also important to note that operating conditions will effect service timetables. Driving in extreme conditions such as heavy dust, continuous short trips, or start and stop heavy traffic means that service durations will be shortened. Discuss service timetables with both your dealer and chassis service representative. Preventative maintenance will pay for itself many times over by catching or preventing problems before they occur. Many repairs costs are greatly increased due to the fact a small problem can begin to effect other parts and systems of the motorhome if left unattended.

If a situation arises involving a maintenance or cleaning activity for which you are not sure of the proper procedure, do not hesitate to contact your dealer, or chassis service representative for information.

CARE AND MAINTENANCE

Fiberglass Siding

The care of fiberglass siding is essentially the same as any automotive finish. Wash your recreational vehicle at least once a month. Use warm water and a mild detergent to clean the finish. Take care to avoid spraying water directly into refrigerator and furnace vents when washing the recreational vehicle. Remove bird and tree sap droppings, insects, and tar as soon as possible to avoid staining of the finish.

It is important to note that any finish will deteriorate with time. Dulling and fading can be increased by exposure to extreme sunlight, air pollutants, and excessive moisture. Surface weathering of fiberglass does not change the strength of the fiberglass. Regular washing and waxing of exterior surfaces is the best insurance against surface deterioration such as fading, yellowing, or chalking.

If surface deterioration has occurred, check with your dealer for the steps required to restore the finish. Buffing may be necessary in extreme cases. Small cracks appearing in the fiberglass can be repaired by using a fiberglass filler. Allow the filler to harden, sand, and then repaint with gelcoat (check with your dealer for further instructions and product information).

Wax fiberglass surfaces at least once a year with a standard liquid or paste wax. Make sure to follow the directions for use as outlined by the product manufacturer. Make sure to wash and wax your unit out of the hot sun when exterior surfaces are cool.

Storage of the recreational vehicle out of direct sun is also a primary way to help preserve fiberglass finishes.

Physical damage to fiberglass should be taken care of immediately to avoid moisture from entering through breaks and causing problems with interior walls and components. Cover breaks in the fiberglass with plastic, sealing the edges with tape until proper repairs can be made.

NOTE: DO NOT use rubbing compound or any abrasive cleaner or cloth on the recreational vehicle. If using a tar and insect remover, make sure it is safe for use on painted surfaces and striping decals.

SEALS AND ADHESIVES

It is important to maintain the seals and adhesives of your recreational vehicle to prevent moisture from entering and destroying recreational vehicle components. When washing your recreational vehicle, inspect the seals for signs of drying out and wear. Be aware that weather, sun, and road vibration will have an effect on seals, causing them to dry, crack, or separate. If you are unsure what to look for, have your dealer instruct you, and also show you the correct method for renewing the seals.



WARNING: Failure to maintain seals through regular maintenance can lead to damage of motorhome components, and may be considered abusive treatment under terms of your recreational vehicle warranty.

FRAME

Check the condition of the frame regularly. Keep it clean, and repaint as necessary to help avoid rust. It is especially important to keep underbody components clean, when driving the recreational vehicle in the winter in areas where road salts are used.

TIRES

In areas where hot sun constantly beats down on the recreational vehicle, shading the tires by covering can reduce tire sidewall cracks from forming.

ROOF

Inspection of roof components at least twice a year is very important to make sure seals are not cracked or worn. Proper maintenance of seals is necessary to keep moisture from entering and causing severe damage such as rot, mold, or mildew. If you encounter drying, cracked, or weathered seals, make sure to reseal as necessary. Check with your dealer for the type of caulking required for roofs and correct methods of resealing. Special sealers are also required for the skylights.

It is especially important to check the seals before and after periods of extended storage or non-use. Fall and spring inspections are recommended.

NOTE: If your roof should somehow be punctured, cover the puncture to seal out moisture, and have it repaired as soon as possible (check with your dealer).

EXTRUSIONS AND ALUMINUM SURFACES

Clean and wax all extrusions when waxing recreational vehicle sidewalls, to help avoid surface pitting. Special aluminum cleaners are available to restore the original luster to aluminum surfaces. Make sure to follow the instructions for use as outlined on the product package.

Chrome surfaces can be restored with special chrome polish if regular cleaning methods are not successful. Again, make sure to follow product instructions for use.

WINDOWS AND DOORS

Check the seals around the windows at regular intervals. Follow previous instructions for checking the condition of seals and repairing as necessary.

Make sure that windows remain operative by adjusting and lubricating latches and moving parts annually. Also check the condition and operation of the door locks, adjusting and lubricating as necessary. Use powdered graphite or light oil to lubricate moving parts on doors and windows.

Vinyl seals around windows and doors should be cleaned regularly, and kept supple by use of a silicone spray (make sure to follow the directions on the product).

Keep screens and window slides clean and free of debris, to maintain proper operation, and avoid component road damage. Test the operation of all windows occasionally to make sure they are working properly, including closing flush and locks holding tight.

Check with your dealer if you are unsure about the correct methods of lubrication and adjustment.

NOTE: Be aware that moisture can accumulate in locks and hinges of windows and doors, causing damage or faulty operation. Do not force the operation of these components in sub-freezing weather.

LP GAS SYSTEM

The LP gas system should be checked regularly for leaks and damage. Follow the lines, looking for kinks or flattened spots that could have occurred during travel or maintenance on the recreational vehicle. The entire system, including regulator pressure, should be checked annually, or whenever you suspect a problem, by a qualified LP gas service technician using proper equipment. The method of checking the system for leaks, and LP gas safety precautions can be found elsewhere in this manual.

NOTE: Line pressure for LP gas appliances should be checked at least every six months. Most LP gas suppliers have equipment to make the test for you. The correct line pressure for all of the LP gas appliances is 11" of water column pressure.

DRAINAGE SYSTEM

The drainage system, including the tanks and associated drain piping should be periodically inspected for road damage. Any deterioration of the sealant around joints and fittings should be repaired immediately.

Check the operation of the termination valves. If they pull or close with effort, lubricate the shaft and slide valve with spray silicone. Termination valves that leak should be repaired or replaced as soon as possible.

Sometimes, a buildup of paper or other material in the inside groove of the termination valve can obstruct the valve and cause it to seat improperly. If you suspect that this is occurring, the valve can be removed from the drainage line by removing the four screws that hold it in place and sliding it out. The valve groove may then be cleaned out with a screwdriver or similar tool. Replace the valve in the line and reinstall the screws to secure it in place.

EXTERIOR LIGHTS

Make sure to check the operation of all exterior lights often. Check identification, clearance, turn signal, brake, and backup lights to make sure they are working correctly. Replace burnt out bulbs as soon as possible.

TV ANTENNA

To lubricate the elevating gear, apply a liberal amount of silicone spray lubricant to the elevating gear with the lift in the down position. Run the lift up and down a few times to distribute the lubricant over the gears.

If rotating the antenna becomes difficult, normal operation can be restored by lubricating the bearing surface between the rotating gear housing and the base plate. Any spray type silicone lubricant may be used.

Elevate the antenna and remove the set screw from the rotating gear housing (see illustration). Spray lubricant into hole and around the edges of the gear housing. Rotate the gear housing until the lubricant coats the bearing surfaces and the antenna rotates freely.

Lubricating the Antenna

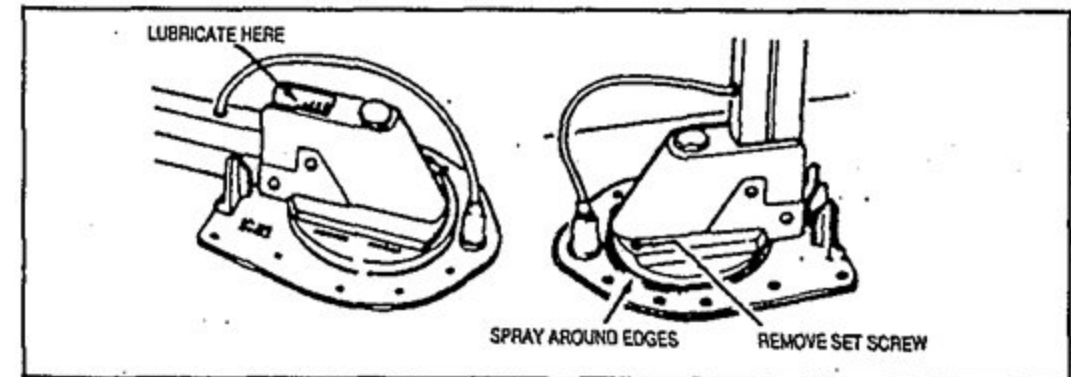

APPLIANCES, SINKS, AND COUNTERTOPS

Clean with hot soapy water or a good liquid cleaner. Avoid using abrasive cleaners. Never use steel wool on stainless steel, since the steel particles left in the sink can rust and become unsightly. Also, when cleaning stainless steel with a mild cleanser, rub gently with the grain, and rinse well. Rinse after each use and wipe dry.

Be sure to remove all food and ice from the refrigerator at the end of each trip. Prop the door open slightly to keep the interior dry, and free of mold, mildew, and odors.

Make sure to read all literature provided with each of the appliances, and follow the maintenance instructions included. Pay particular attention to any cautions or warnings included. Also read the rest of this manual, following the instructions for the care and use of appliances.

Do not place hot pans directly on countertops, because they can loosen or scorch surface.

PRE-FINISHED PANELS AND WOOD SURFACES

Treat cabinetry and wood surfaces as you would any fine furniture product in your home. Proper care and maintenance of wood products will keep them looking like new for many seasons of use.

Clean pre-finished panels with a spray-type furniture polish. Avoid getting wood surfaces wet. Wipe off and dry immediately if you do get wet. Do not use abrasive cleansers around wood finishes. Clean regularly with a soft cloth and cleaner designed for wood products such as lemon oil or any oil based wood cleaning product. Avoid constant exposure to direct sunlight which can cause fading and drying of wood surfaces.

WATER SYSTEM

Check all hoses, fittings, and connections regularly for leaks and signs of wear. Make sure to keep the system sanitized, and take care to winterize during cold weather (see instructions elsewhere in this manual). Do not allow water to remain in system for extended periods or after a trip.

ELECTRICAL SYSTEM

The electrical system requires minimal maintenance under normal circumstances. Most electrical maintenance in the recreational vehicle involves the chassis and auxiliary batteries. Keeping the batteries properly maintained will help to eliminate many frustrating electrical problems. Make sure to refer to the index for the location of electrical and battery maintenance elsewhere in this manual.

The generator is another area in which simple preventive maintenance can "head off" problems before they happen. Read the manual supplied with the generator for the care and maintenance required on a regular basis.

If you experience electrical problems with your recreational vehicle, make sure to have it checked by a qualified electrician.

ROOF VENTS

Check roof vents regularly for debris that may block air flow or jam the cranking mechanism. Lubricate the cranking mechanism with light oil.

ABS PLASTIC

Many components of the recreational vehicle are constructed of strong, lightweight ABS plastic. Sometimes, it may be necessary to remove stains, or generally clean. A mild solution of soap and water will clean many stains, and should be used initially. Tougher stains may require stronger cleaners, but be sure to read the label to determine if the product is recommended for use on plastics.

Avoid abrasive cleansers (even the liquid and cream types), alcohol based products, and solvents such as acetone and MEK. Gasoline and kerosene should not be used because of the damaging effect they have on the plastic surface, as well as the fire hazard they present. Often the damage caused by solvents, alcohol, and oil based products may not be immediately noticeable, but the plastic is made weaker, and prone to stress cracking.

WINTER PRECAUTIONS

Special Tips for Winter Use

Water Systems — If the fresh water storage tank is located inside the coach, the normal heating of the coach during cold weather should be enough to insure its not freezing. In severe cold however, it is wise to monitor the water temperature in the tank, and take appropriate steps to drain and winterize if necessary. In severe cold it may be necessary to open lower cabinet doors at night in both the bath and kitchen areas to keep warmer air circulating around water fixtures.

If you are going to have to leave the coach unheated for any length of time in severe cold conditions, it is best not to keep water in the fresh water tank. It may work best to carry cooking and drinking water with you in plastic jugs instead.

If you will be using your recreational vehicle when conditions fall below the freezing level, it will be necessary to protect the drainage system components from damage by the addition of an approved antifreeze solution as outlined on the product directions. Drain lines which are exposed outside the recreational vehicle are especially susceptible to freezing, and steps should be taken to protect them from damage.

Food Storage — In the event the recreational vehicle is left for a period of time without the furnace in operation, canned goods and other foods packed in water should be stored as high as possible, since heat rises. They might also be stored in the refrigerator as insulation against the cold. Store dry foods, and other items that are not damaged by freezing in the lower storage areas.

LP Gas System — Make sure to use an LP gas that will vaporize properly in the colder temperatures. Check with your LP gas representative for the proper fuel, and reread the information on LP gas selection in the LP Gas section of this manual (check the Index for the location).

NOTE: It is important to remember that heating with LP consumes gas rapidly, so refill tank immediately when low, to avoid running out completely.

Heating — Use ONLY the furnace to heat the recreational vehicle. It is properly vented to the outside. NEVER USE THE RANGE FOR HEATING — ASPHYXIATION COULD RESULT.

Condensation — Cooking produces large amounts of moisture. Not just as steam from pots and pans, but also as a product of combustion. Make sure to use the exhaust vents and open a window slightly to control the humidity. At night, leave a roof vent and/or a window slightly open.

STORAGE PREPARATION

When storing the recreational vehicle for the winter (or other extreme conditions), certain precautions need to be made to protect it until you open it again for use. Make sure to talk with your local dealer concerning any special requirements for storage in your particular geographic area. The following steps are general, and your dealer can help you choose those that are most appropriate for your needs.

1. Make sure to park the recreational vehicle on a level surface.
2. Make sure to winterize the chassis as outlined in the chassis owner's manual, and also the 110V generator (if so equipped) as outlined in the generator owner's manual.
3. Clean the recreational vehicle thoroughly, both inside and out, as previously outlined, including the refrigerator.
4. Make sure all electrical switches and appliances are turned off.
5. Close all the drapes and curtains, and protect the curtains from sun fading by placing foil, or paper between the windows and the screens.
6. Make sure all windows, doors, and vents are closed securely. Cover exterior vents on appliances to prevent moisture and insects from entering during storage.
7. Check the interior of the recreational vehicle periodically while in storage to make sure leaks have not developed, or condensation formed that can cause damage to interior components. Condensation can most readily be observed as moisture accumulation on windows and mirrors. To reduce condensation, make sure to air the recreational vehicle out occasionally during storage.
8. Be sure that both the chassis and auxiliary batteries have the proper electrolyte level and that they are fully charged (specific gravity of 1.260). A discharged battery will freeze and crack the case, ruining the battery. In storage, a battery will lose charge gradually over a 30 to 45 day period, even when disconnected by use of the battery disconnect switch. We recommend that at least monthly the batteries be checked for charge. If the charge is 80% (specific gravity of 1.235) or less, it must be recharged.

You may wish to remove the batteries from the recreational vehicle and store them in a heated area. However, even when warm, the battery charge level must still be maintained. A warm battery accepts charge much more readily however, than a cold one.

Make sure to follow all precautions associated with battery care and maintenance outlined in the electrical section of this manual.

9. Store with as much fuel as possible in the fuel tank to limit condensation buildup.
10. Check engine coolant, making sure antifreeze is sufficient for local temperature extremes.
11. Make sure the tires are inflated to correct pressures.
12. Store the windshield wiper arms and blades inside the motorhome.
13. Let the engine run for a period of time until it is warm. Change the oil and oil filter.
14. Run the air conditioner during this final engine warm up to make sure the compressor seal is lubricated.
15. If snow accumulates on the recreational vehicle, try to remove it as often as you can.
16. A primary concern when winterizing the recreational vehicle is to make sure the water systems are protected against damage caused by freezing. Follow the water system winterizing procedure outlined in the Water and Drainage section of this manual (check the Index for location).

Be sure to read the rest of this manual, and follow any additional information on storage, cleaning, and winterizing procedures.

PERIODIC MAINTENANCE CHART

ITEM	Frequency						PROCEDURE
	Ex. Dip	Ex. Mo.	3 Mo.	6 Mo.	Ex. Year	*As Req.	
Fiberglass Exterior		X		X			Wash with warm water & mild detergent Wax with liquid or paste wax
Roof & Roof Components				X	X		Inspect & re-seal as needed Lubricate roof vent mechanism w/light oil & clean completely
Windows & Doors		X	X	X	X	X	Check vinyl seals when washing exterior Check seals for damage & repair as needed Lubricate door hinges & step components with WD40 Adjust & lubricate window latches with powdered graphite or light oil Lube door locks & strike pocket, incl. ext. storage & access doors
Seals & Adhesives		X					Inspect & reseal as necessary
LP Gas System					X	X	Check for leaks & road damage Have qualified serviceman check pressures & complete system
Water & Drainage	X	X			X	X	Check hoses, fittings & connections for leaks & signs of wear Check drainage system for leaks & road damage Sanitize system Winterize system depending on local seasonal conditions
Electrical System		X			X	X	Check GFCI circuits Perform maint. on generator as outlined in generator manual Check & service batteries
Appliances	X	X	X				Remove food & ice from refrigerator after each trip Clean fan blades & wash filter on range exhaust hood Check for obstructions & dirt on exterior appliance vents
Safety Equipment	X	X			X		Clean smoke detector components Test smoke detector operation Check fire extinguisher pressure & condition
Carpeting	X				X		Vacuum after each trip Clean
Wood Surfaces		X					Clean pre-finished panels & wood
Seats					X	X	Lubricate all mechanisms & inspect for proper operation Check all seat belt buckles, release mechanisms & belt webbing
Chassis & Components					X		Follow chassis lubrication & maint procedures & schedules
Weight & Distribution	X						Be sure unit is within specified load limits & weight distribution