

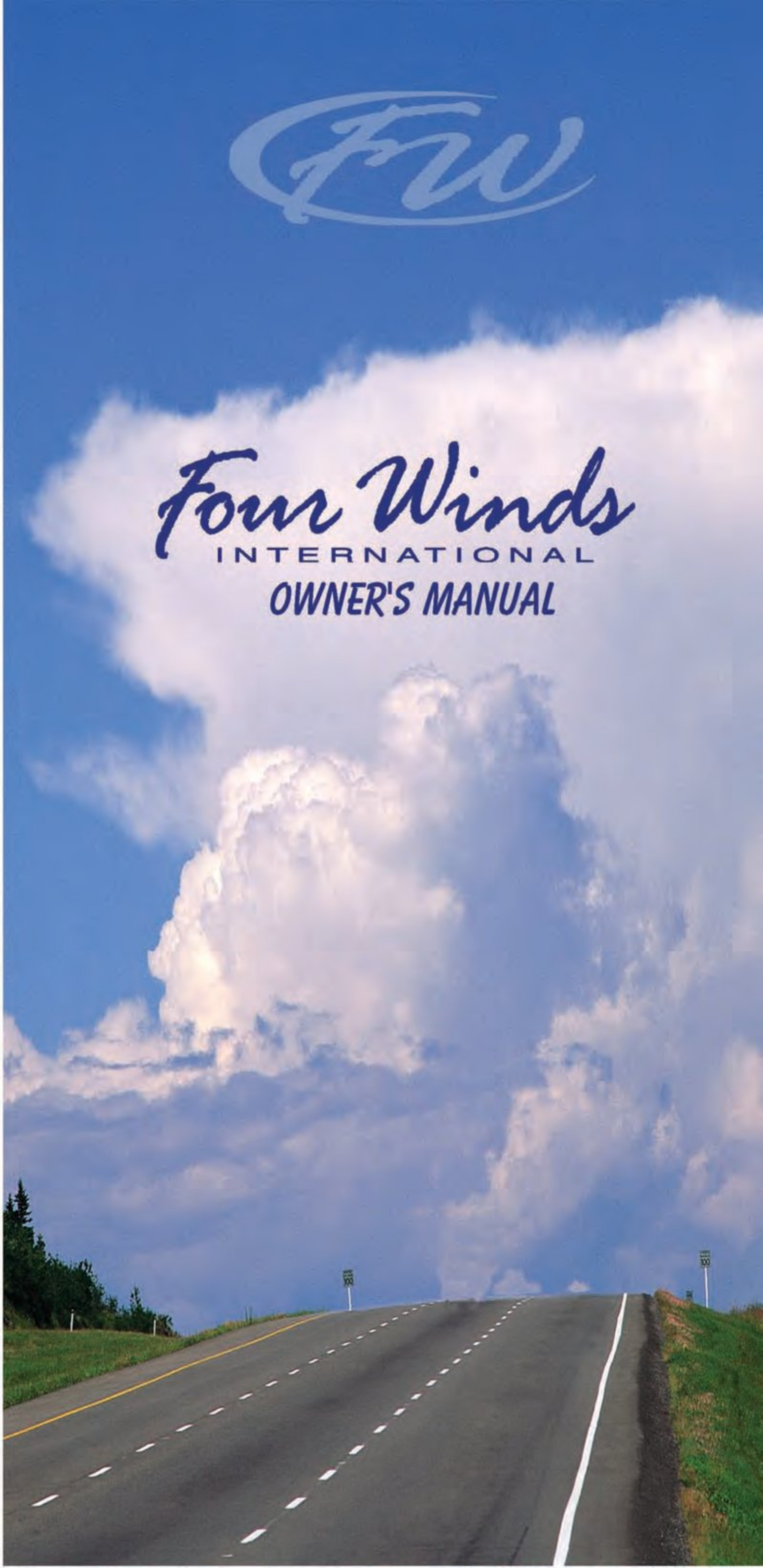

*Four Winds*  
INTERNATIONAL  
*OWNER'S MANUAL*



# ADDENDUM

## Corrected information from Chapter 5 Pages 10 and 11

The hose color identification information on Chapter 5 pages 10 and 11 for the Emergency Manual Retraction Procedure is incorrect. Please refer to the information below for correct coloring.

<b>HOSE COLOR IDENTIFICATION</b>		
<b>LOCATION</b>	<b>EXTEND ( T )</b>	<b>RETRACT ( B )</b>
JACK # 1 (LEFT FRONT)	T1 - BROWN	B1 - BROWN / BLACK
JACK # 2 (RIGHT FRONT)	T2 - WHITE	B2 - WHITE / BLACK
JACK # 3 (LEFT REAR)	T3 - ORANGE	B3 - ORANGE / BLACK
JACK # 4 (RIGHT REAR)	T4 - YELLOW	B4 - YELLOW / BLACK

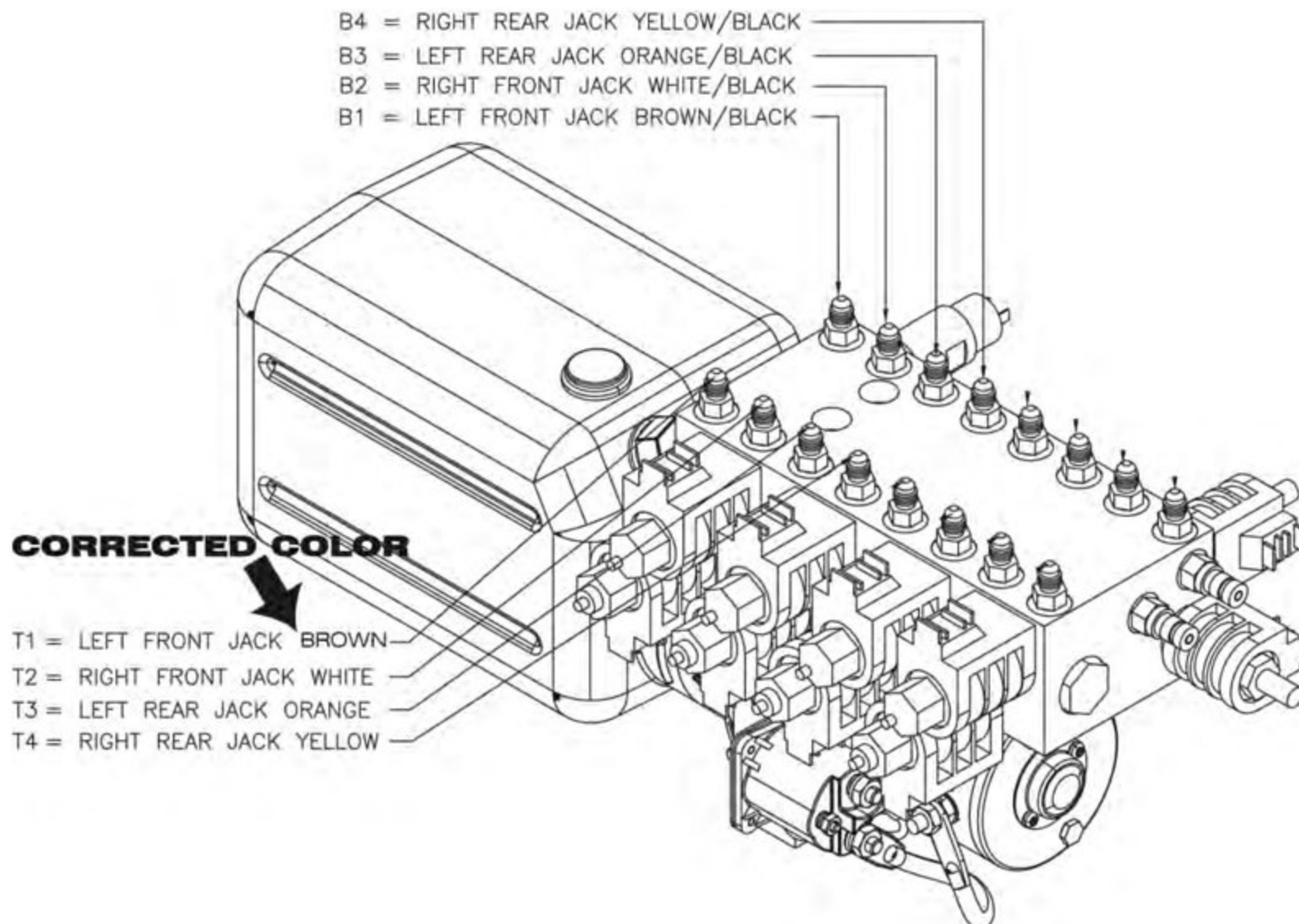

### HOSE CONNECTION IDENTIFICATION

T = EXTEND  
 B = RETRACT



## RECREATION VEHICLE SHORE POWER ADDENDUM

FOUR WINDS INTERNATIONAL OWNER'S MANUAL

Print Date 07/2007

05/2010 MS

The following information supersedes the information printed within the Four Winds International Owner's Manual (Print Date 07/2007), in the Electrical Systems Section, page 7/2 under the 30 AMP SHORE POWER HEADING.

### SHORE CORD

#### **⚠ DANGER**

**Connecting the shore cord to a non-grounded or improperly grounded power source can result in dangerous and possibly fatal electric shock. Due to the potential danger in failing to heed this warning, the recreation vehicle manufacturer cannot be responsible should damage, injury, or death result from failure to connect the power cord to a properly grounded power source.**

#### **⚠ WARNING**

**If shore power service is limited to 15 or 10 amps, use of light duty extension cords and electrical adapters will create a Voltage loss through the cord and at each electrical connection. Line Voltage loss and the resistance at each electrical connection can be a hazardous combination. Damage to sensitive electronic equipment may result.**

### *30 Amp Shore Power*

#### **⚠ WARNING**

**" The recreation vehicle is designed to be connected to a 30 amp service which provides 120 Volts. The motor home should never be connected to any power source that will provide anything more than 120 Volts. Failure to follow this will result in serious damage to internal items that are plugged in"** 

A 30 amp shoreline power cord is provided to attach the recreation vehicle to a grounded power source. The electric utility service connection is located on the driver's side of the recreation vehicle near the rear, in various locations depending on the model that you have. The power cord is stored inside the electric utility service compartment. The electric utility service door has a slot with a cover that can be moved to the side, allowing the power cord to be used and the door to be closed and locked for security.

When connecting or disconnecting from a grounded external power source, always turn off the shore power breaker to the power supply outlet. This will prevent accidental shock and flashing of electrical contacts. After connecting the recreation vehicle to the grounded external power source, wait a few minutes for the inverter/charger (if equipped) to stabilize charging of the batteries before starting large AC loads such as the air conditioner.



***Four Winds International  
Corporation  
Owners Manual***

**THIS PAGE TO BE COMPLETED BY THE SELLING DEALER AND KEPT IN YOUR FOUR WINDS RV FOR REFERENCE WHEN WARRANTY SERVICE IS REQUIRED.**

**OWNER REGISTRATION CARD**

Date of Purchase	Four Winds Serial No.	Model	Year
------------------	-----------------------	-------	------

Chassis Serial No.	Chassis Manufacturer	Mileage
--------------------	----------------------	---------

**THIS PRODUCT WILL BE WARRANTED IN THE NAME OF:**

<b>OWNER</b> Mr. <input type="checkbox"/> Mrs. <input type="checkbox"/> Ms. <input type="checkbox"/>	<b>DEALER</b>
Owner's Name (Last, First Middle)	Selling Dealer
Regular Mailing Address - Street or P.O. Box	Regular Mailing Address - Street or P.O. Box
City                      State              Zip	City                                      State                      Zip
Telephone (Area Code)              Cell Phone	Telephone (Area Code)

**COMPLETE THIS REGISTRATION CARD WITH THE SELLING DEALER  
AND RETURN WITHIN 10 (TEN) DAYS OF THE PURCHASE DATE.**

<b>OWNER REGISTRATION CARD</b>			
Date of Purchase	Four Winds Serial No.	Model	Year
Chassis Serial No.	Chassis Manufacturer	Mileage	
<b>THIS PRODUCT WILL BE WARRANTED IN THE NAME OF:</b>			
<b>OWNER</b> Mr. <input type="checkbox"/> Mrs. <input type="checkbox"/> Ms. <input type="checkbox"/>		<b>DEALER</b>	
Owner's Name (Last, First Middle)		Selling Dealer	
Regular Mailing Address - Street or P.O. Box		Regular Mailing Address - Street or P.O. Box	
City	State	Zip	
Telephone (Area Code)	Cell Phone		
E-mail Address	Telephone (Area Code)		
<b>Owner's Signature (MUST BE SIGNED)</b>		Please type or print and mail this form within 10 days of purchase to: <b>FOUR WINDS INTERNATIONAL CORPORATION</b> P.O. Box 1486, Elkhart IN 46515	

Four Winds International Corporation - PO Box 1486 - Elkhart, IN 46515 - (575) 266-1111

Four Winds International Corp.  
Attn: Warranty Department  
P.O. Box 1486  
Elkhart, IN 46515-1486

# NOTES





# NOTES



# FOUR WINDS INTERNATIONAL CORPORATION NEW RECREATION VEHICLE LIMITED WARRANTY

## WARRANTY COVERAGE - 12 MONTH/15,000 MILES

### WHAT IS COVERED

Four Winds International Corporation (hereafter Four Winds), warranty shall be applicable to model year 2007 recreation vehicles (hereafter RV), when used only for recreational travel and camping, for one (1) year or the first fifteen thousand (15,000) miles of use, whichever occurs first. The warranty period begins on the date that the RV is delivered to the first retail owner by an independent, authorized Four Winds dealer. In the event that a substantial defect in material or workmanship, attributable to Four Winds, is found to exist during the warranty period, Four Winds will repair or replace the defective material or workmanship, at its option, at no charge to the RV owner, in accordance with the terms, conditions and limitations of this Limited Warranty.

This Limited Warranty only applies to the first retail owner of the RV. All rights and limitations within this warranty are applicable to first retail owner, and all owners must complete the Warranty Registration Form contained in the Owner's Manual and send it to Four Winds.

Four Winds' obligation to repair or replace defective materials or workmanship is the sole obligation of Four Winds under this Limited Warranty. Four Winds reserves the right to use new or remanufactured parts of similar quality to complete any work. The RV owner's obligation to notify Four Winds, or one of its authorized, independent dealers, of a claimed defect does not modify any obligation placed on the RV owner to contact Four Winds directly when attempting to pursue remedies under state or federal law.

### LIMITATIONS AND DISCLAIMER OF IMPLIED WARRANTIES

The following limitations and disclaimers apply to the original purchaser of the RV, any person to whom the RV is transferred and any person who is an intended or unintended user or beneficiary of the RV. **ANY IMPLIED WARRANTY ARISING BY WAY OF STATE OR FEDERAL LAW, INCLUDING ANY IMPLIED WARRANTY OF MERCHANTABILITY OR ANY IMPLIED WARRANTY OF FITNESS, ARE LIMITED IN DURATION TO THE LENGTH OF THIS LIMITED WARRANTY AND ARE LIMITED IN SCOPE OF COVERAGE TO THOSE PORTIONS OF THE MOTORHOME COVERED BY THIS LIMITED WARRANTY. PERFORMANCE OF REPAIRS OR NEEDED ADJUSTMENTS IS THE EXCLUSIVE REMEDY UNDER THIS LIMITED WARRANTY OR ANY IMPLIED WARRANTY.** Four Winds makes no warranty of any nature beyond that contained in this Limited Warranty. No one has the authority to enlarge, amend or modify this Limited Warranty. The dealer is not Four Winds' agent, but is an independent entity.

In addition, Four Winds **SHALL NOT BE LIABLE FOR ANY INCIDENTAL OR CONSEQUENTIAL DAMAGES THAT MAY RESULT FROM BREACH OF THIS LIMITED WARRANTY OR ANY IMPLIED WARRANTY. THIS EXCLUSION OF CONSEQUENTIAL AND INCIDENTAL DAMAGES SHALL BE INDEPENDENT OF ANY FAILURE OF THE ESSENTIAL PURPOSE OF ANY LIMITED WARRANTY, AND THIS EXCLUSION SHALL SURVIVE ANY DETERMINATION THAT THIS LIMITED WARRANTY OR ANY IMPLIED WARRANTY HAS FAILED OF ITS ESSENTIAL PURPOSE.**

Some states do not allow limitations on how long an implied warranty lasts, or the exclusion or limitations of incidental or consequential damages. Therefore, the above limitations may not apply to you.

### **36 MONTH/45,000 MILE LIMITED STRUCTURAL WARRANTY**

In addition to the above terms and conditions, Four Winds International Corporation warrants to the first retail owner purchased from an authorized dealer that the structural components of your RV will be free of substantial defects in material and workmanship for a period of thirty-six (36) months from the date of retail purchase or for the first 45,000 miles of usage, whichever occurs first.

For the purpose of this warranty, "structural components" shall be limited to the structure of the sidewalls, front and back wall, roof, and floor.

Damaged caused by misuse, abuse, collision, alteration, failure to properly maintain the exterior sealants, cosmetic defects, improper repairs, discoloration, and normal deterioration is not covered by this 36 month/45,000 mile limited structural warranty. Maintenance such as periodic resealing of the windows, molding, doors, vents, awnings, and other exterior-mounted components, and damage caused by the failure to adhere to the prescribed maintenance chart in this manual is excluded from this coverage.

### **HOW TO GET SERVICE**

To obtain warranty service the owner must do all of the following:

- 1) Complete and return the Owner Registration Card within ten (10) days of purchase;
- 2) Notify Four Winds, or one of its authorized, independent dealers, in writing, of any claimed defect within the warranty coverage period;
- 3) Provide the notification mentioned in (2), above, within ten (10) days of discovery of the defect; and
- 4) Promptly return the RV to an authorized dealer for repairs.

For warranty service simply contact one of Four Winds' independent, authorized service centers for an appointment and then deliver your RV to the service center on the specified appointment date. If you need assistance contact Four Winds at (574) 266-1111. The mailing address is PO Box 1486, Elkhart, Indiana 46515.

If two or more service attempts have been made to correct any covered defect that you believe impairs the value, use or safety of the RV, you must, to the extent permitted by law, notify Four Winds directly, in writing, of the unsuccessful repair of the alleged defect so that Four Winds can become directly involved in making sure that you are provided service pursuant to the terms of this limited warranty.

Because Four Winds does not control the scheduling of service work at any service center you may encounter delays in scheduling and/or the completion of work. All costs associated with transporting the RV for any warranty service shall be the sole responsibility of the RV owner.

### **WHAT IS NOT COVERED**

This Limited Warranty does not cover any material, component or part of the RV that is warranted by another entity, including, by way of example, but not limited to; the automotive chassis and power train, including the engine, drive train, steering, handling, braking, wheel balance, muffler, tires, tubes, batteries and gauges, generator, hydraulic jacks, inverter, range, carbon monoxide detector, furnace, roof air conditioner, refrigerator, audio/video equipment and microwave.

Minor adjustments such as adjustments to the interior or exterior doors, drawers, latches, etc. will be performed by the dealer during the first 90 days of warranty coverage. Thereafter, such adjustments are the owners' responsibility as normal maintenance.

In addition, by way of example only, this Limited Warranty does not cover any of the following: items that are added or changed after the Motorhome leaves Four Winds; any RV used for rental or other commercial purposes (Note: It shall be assumed the Motorhome has been used for rental or business purposes if the RV is purchased or registered in a company name, or if the RV owner claims a tax benefit on a tax form) ; normal wear, tear or usage, such as fading or discoloration of fabrics or the effects of condensation inside the RV; items that are working as designed but that you are unhappy with because of the design; problems related to misuse, including failure to maintain RV in accordance with the owner's manual, or failure to perform other routine maintenance; damage due to accident whether or not foreseeable, including any acts of weather or damage or corrosion due to environment, rust, theft, vandalism, fire, or other intervening acts not attributable to Four Winds; cost related to transportation, lodging, loss or damage to personal property, loss of owner's product, inconvenience, loss of income, rental vehicles; glass breakage; damage from misuse of equipment used for purposes other than intended design; damage resulting from tire wear or tire failure; defacing, scratches, dents, chips on any surface or fabric of the RV; damage caused by off road use, overloading the RV or alteration of the RV, or any of its components. Parts and labor for expendable service maintenance items including, but not limited to, wiper blades, bulbs, fluids and filters are excluded from warranty coverage.

It is the owner's responsibility to take any necessary preventative maintenance measures, as described in the care and maintenance section of the Four Winds International owners' manual including periodic maintenance of exterior caulking and sealers. It is the responsibility of the owner to take necessary measures to prevent secondary damage from rainwater, plumbing leaks, condensation, and the natural accumulation of moisture in your recreation vehicle. Failure to do so may result in stains, damage, separation, and formation of mold to the floor, walls, upholstery, carpeting, furniture, drapes and other components. Mold is a natural growth given certain environmental conditions and is not covered by the terms and conditions of the Four Winds International Limited Warranty.

Chemical Off-gassing is not a "defect" in your recreational vehicle and is not covered by the Four Winds International Limited Warranty. Please refer to the Safety Section (Section 2 Page 12) of this manual for additional information.

### **LEGAL REMEDIES/ARBITRATION**

Four Winds International Corporation participates in the Consumer Arbitration Program for Recreation Vehicles (CAP-RV). This third-party dispute resolution program is available, at no charge to you, to settle unresolved warranty disputes for recreation vehicles. This dispute resolution program reviews eligible product and service related complaints involving warranty covered components.

To find out more about the program, or to request an application/brochure, please call the Arbitration Administration office toll-free 800-279-5343.

For recreation vehicles purchased in the State of California: The CAP-RV program operates as a certified mechanism under the review of the California Arbitration Certification Program. You must utilize the

arbitration program before claiming rights conferred by 15 USC section 2310 (Uniform Commercial Code) or Civil Code section 1793.22(b) (Song-Beverly Warranty Act). You are not required to use the program if you choose to seek redress by pursuing rights and remedies not created by those laws.

Any action to enforce any portion of this express, Limited Warranty, or any implied warranty, shall be commenced within one (1) year after expiration of the warranty coverage period designated above or as required by law. Any performance of repairs shall not suspend this one-year limitation period from expiring. Any performance of repairs after the warranty coverage period has expired, or performance of repairs regarding any thing excluded from coverage under this Limited Warranty, shall be considered good will repairs, and they will not alter the express terms of this Limited Warranty, or extend the warranty coverage period or this limitation period. In addition, this warranty is not intended to extend to future performance, and nothing in this warranty, or any action of Four Winds, shall be interpreted as an extension of the warranty or this limitation period.

THIS WARRANTY GIVES YOU SPECIFIC LEGAL RIGHTS. YOU MAY HAVE OTHER RIGHTS THAT VARY FROM STATE TO STATE.

Four Winds International Corporation PO Box 1486 Elkhart, IN 46515 (574)-266-1111

# TABLE OF CONTENTS

**INTRODUCTION** **Chapter 1**

---

**SAFETY** **Chapter 2**

---

REPORTING SAFETY DEFECTS . . . . .	1
SAFETY SYMBOLS . . . . .	1
LP GAS SYSTEMS & APPLIANCE SAFETY REGULATIONS . . . . .	2
FIRE SAFETY . . . . .	3
FIRE EXTINGUISHER . . . . .	4
CARBON MONOXIDE ALARM & SMOKE ALARM . . . . .	4
LP GAS DETECTOR . . . . .	7
SEAT BELTS . . . . .	9
EGRESS WINDOW . . . . .	11
MOLD . . . . .	11
CHEMICAL SENSITIVITY . . . . .	12
MOTORHOME/CARGO VAN SAFETY (Dual Purpose Vehicle) . . . . .	13
FUN MOVER TIE DOWN SAFETY INSTRUCTIONS . . . . .	14

**IDENTIFICATION & TRAVEL PREP** **Chapter 3**

---

RECREATIONAL VEHICLE SERIAL NUMBER, DECALS, AND DATA PLATES . . . . .	1
MANUFACTURER'S WARRANTIES . . . . .	1
FIRST SHORT TRIPS . . . . .	2
TRAVEL PREPARATION . . . . .	3

**AUTOMOTIVE OPERATIONS AND PROCEDURES** **Chapter 4**

---

GENERAL INFORMATION . . . . .	1
NEW VEHICLE BREAK IN . . . . .	1
FOOT SERVICE BRAKES . . . . .	1
WHEELS AND TIRES . . . . .	1
TIRE INFLATION INFORMATION . . . . .	2
CHANGING A TIRE . . . . .	3
WHEEL NUT TORQUE . . . . .	3
SPARE TIRE HOIST . . . . .	4
FLIP DOWN STYLE TIRE CARRIER . . . . .	5
WHEEL AND TIRE BALANCING . . . . .	5
FRONT SUSPENSION AND ALIGNMENT . . . . .	5
POWER PLANT AND DRIVE TRAIN . . . . .	6
ENGINE ACCESS . . . . .	6



**AUTOMOTIVE OPERATIONS AND PROCEDURES (CONTINUED) Chapter 4**

ENGINE COOLING SYSTEM . . . . . 6  
PROPER LOADING AND WEIGHT DISTRIBUTION . . . . . 7  
COMPUTING YOUR LOAD AND LOAD DISTRIBUTION — (Motorized Rvs) . . . . . 8  
DRIVING . . . . . 11  
HILLS, DALES AND MAKING THE GRADE . . . . . 12  
TRAILER TOWING. . . . . 12  
EMERGENCY STOPPING AND TOWING. . . . . 13  
TOWING PROCEDURES . . . . . 14  
FUEL PUMP COLLISION SHUTOFF SWITCH . . . . . 14  
FUEL RECOMMENDATIONS . . . . . 15  
FUEL FILLING . . . . . 15

**DASH CONTROLS & INSTRUMENT PANEL Chapter 5**

DASH CONTROLS (Class C Mini Motorhomes) . . . . . 1  
DASH CONTROLS (Class A Motorhomes) . . . . . 1  
CHASSIS INSTRUMENT PANEL . . . . . 1  
HEADLIGHT SWITCHES . . . . . 2  
WIPERS. . . . . 2  
GENERATOR REMOTE SWITCH AND HOUR METER . . . . . 2  
CIGARETTE LIGHTER . . . . . 2  
HEATED MIRROR SWITCH . . . . . 2  
POWER MIRROR ADJUSTMENT . . . . . 2  
DASH HEATER/AIR CONDITIONER . . . . . 3  
CD PLAYER. . . . . 6  
DASH SWITCH PANEL . . . . . 6  
HYDRAULIC POWER LEVELERS (Optional) . . . . . 7  
AUTO LEVELING & RETRACTION PROCEDURES (Hydraulic). . . . . 8  
MANUAL LEVELING & RETRACTION PROCEDURES (Hydraulic) . . . . . 8  
EMERGENCY RETRACTION PROCEDURE (Hydraulic) . . . . . 10  
DRIVER AND PASSENGER SEATS. . . . . 11  
REAR VISION TV MONITOR SYSTEM . . . . . 12

**INTERIOR CONTROLS AND OPERATIONS Chapter 6**

SLIDE-OUT ROOM ROOM - HYDRAULIC . . . . . 1  
SLIDE-OUT ROOM EXTENSIONS - NON-HYDRAULIC . . . . . 4  
WINDOWS . . . . . 5  
DOORS, DRAWERS AND STORAGE COMPARTMENTS . . . . . 5  
SEATING, TABLES AND ADDITIONAL BEDS . . . . . 6  
OVERHEAD VENTS . . . . . 8

**EXTERIOR OPERATIONS Chapter 7**

ENTRY DOOR . . . . . 1  
STEP . . . . . 1  
POWER STEP . . . . . 1  
STORAGE. . . . . 2

**EXTERIOR OPERATIONS (CONTINUED) Chapter 7**

LADDER / ROOF ACCESS . . . . . 3  
SLIDE-OUT AWNING . . . . . 3

**LP GAS SYSTEM Chapter 8**

GENERAL INFORMATION . . . . . 1  
FILLING THE LP GAS TANK . . . . . 2  
LP GAS REGULATOR . . . . . 2  
REGULATOR FREEZE-UP . . . . . 3  
HOSES, PIPES, TUBES AND FITTINGS . . . . . 4  
CHECKING THE LP GAS SYSTEM FOR LEAKS. . . . . 5  
LP GAS LEAK DETECTION SYSTEM (C.C.I. Model 40-442A) . . . . . 5  
LP GAS SAFETY PRECAUTIONS . . . . . 7

**ELECTRICAL SYSTEM Chapter 9**

GENERAL INFORMATION . . . . . 1  
CONNECTING TO AN OUTSIDE POWER SOURCE. . . . . 1  
BATTERIES . . . . . 3  
BATTERY SAFETY . . . . . 3  
BATTERY MAINTENANCE . . . . . 4  
AUTOMOTIVE 12 VOLT SYSTEM . . . . . 5  
BATTERY ISOLATOR CONTROLLER . . . . . 6  
BATTERY ISOLATOR . . . . . 6  
RS400 INVERTER . . . . . 7  
POWER CONVERTER . . . . . 7  
BATTERY CHARGING . . . . . 8  
BATTERY DISCONNECT SWITCH (Some Models) . . . . . 8  
GROUND FAULT CIRCUIT INTERRUPTER . . . . . 9  
CIRCUIT BREAKERS . . . . . 10  
12 VOLT FUSES . . . . . 10  
GENERATOR . . . . . 11

**WATER AND DRAINAGE Chapter 10**

GENERAL INFORMATION . . . . . 1  
FRESH WATER SYSTEM. . . . . 1  
SANITIZING THE FRESH WATER SYSTEM . . . . . 3  
MONITOR PANEL. . . . . 5  
WASTE WATER SYSTEM . . . . . 7  
HOLDING TANKS. . . . . 7  
FAUCETS . . . . . 9  
TOILET . . . . . 9  
WATER SYSTEM WINTERIZATION. . . . . 10  
WATER SYSTEM MAINTENANCE AND TROUBLESHOOTING . . . . . 11

## **APPLIANCES**

## **Chapter 11**

GENERAL INFORMATION . . . . .	1
REFRIGERATOR . . . . .	1
WATER HEATER . . . . .	2
RANGE . . . . .	2
RANGE HOOD . . . . .	3
MICROWAVE OVEN . . . . .	3
ROOF AIR CONDITIONER . . . . .	3
AIR CONDITIONER SELECTION SWITCHES (30 Amp Service Only) (Some Models) . . .	4
FURNACE . . . . .	5
AUDIO AND VIDEO . . . . .	5
TV ANTENNA . . . . .	5

## **CARE AND MAINTENANCE**

## **Chapter 12**

GENERAL INFORMATION . . . . .	1
FIBERGLASS SIDING . . . . .	1
EXTERIOR PAINT (Optional) . . . . .	2
SEALS & ADHESIVES . . . . .	3
FRAME . . . . .	3
TIRES & RIMS . . . . .	3
ROOF . . . . .	4
EXTRUSIONS & ALUMINUM SURFACES . . . . .	4
WINDOWS & DOORS . . . . .	4
LP GAS SYSTEM . . . . .	5
DRAINAGE SYSTEM . . . . .	5
TV ANTENNA . . . . .	5
EXTERIOR LIGHTS . . . . .	6
APPLIANCES, SINKS & COUNTERTOPS . . . . .	8
PRE-FINISHED PANEL & WOOD SURFACES . . . . .	8
WATER SYSTEM . . . . .	8
ELECTRICAL SYSTEM . . . . .	8
ROOF VENTS . . . . .	8
ABS PLASTIC . . . . .	9
WINTER PRECAUTIONS . . . . .	9
STORAGE PREPARATION . . . . .	10
MOLD . . . . .	11
CONDENSATION . . . . .	12
MOISTURE MANAGEMENT . . . . .	13
<b>PERIODIC MAINTENANCE CHART . . . . .</b>	<b>17</b>
<b>VENDOR CONTACT INFO . . . . .</b>	<b>18</b>

# INTRODUCTION

It's exciting taking ownership for a new purchase as substantial and full of nearly unlimited possibilities for the future as a motorhome.

Thank you for choosing a **Four Winds International** product.

We take your choice seriously. That's why we've engineered this vehicle to meet and, in many cases, exceed federal and state regulations and requirements for vehicles of this type. Our primary concern has been to provide our customers with a beautiful recreation vehicle that is not only dependable and cost effective, but also safe.

To keep this vehicle at peak performance and to obtain the maximum pleasure from its use over an extended period, the owner must take a personal interest in its care and operation. Therefore, before operating it, we suggest that you review the entire contents of this manual. The material within has been prepared in sufficient detail to be of considerable help when you are getting to know your new recreation vehicle.

That is the purpose of this Owner's Manual. It outlines the operation of the unit's various systems and offers many helpful hints that will enable you to obtain the most pleasure from this traveling home.

This manual is intended to explain the majority of the features of our Class A Motorhomes and Mini-Motorhomes. Most of these are similar in nature, however; some features mentioned in this manual may not apply to your specific recreation vehicle.

Review both this manual and the chassis manufacturer's owner's manual with your dealer. Be sure to ask them any questions you have at that time. Also make sure to read all warranty and registration information carefully. Read all component manufacturer's owner's manuals, and validate any individual warranties by completing and mailing individual warranty cards as required.

Refer to the chassis owner's manual supplied by the chassis manufacturer for complete information on the care and maintenance of the chassis.

**COMPLETE THE WARRANTY REGISTRATION CARD IN THIS MANUAL AND RETURN TO US WITHIN 10 DAYS FROM THE DATE OF PURCHASE.**

Always keep this owner's manual with the recreation vehicle for easy reference, making sure to observe all notes and warnings associated with the use of the recreation vehicle. A careful owner is the best insurance against an accident.

THIS OWNER'S MANUAL IS AS CURRENT AS POSSIBLE AT THE TIME YOUR RECREATION VEHICLE WAS PRODUCED. HOWEVER, SINCE OUR PRODUCTS ARE CONSISTENTLY BEING UPGRADED AND IMPROVED; SOME DIFFERENCES MAY OCCUR BETWEEN THE DESCRIPTION IN THIS MANUAL AND THE PRODUCT IN THE RECREATION VEHICLE. IF THIS OCCURS, FOLLOW THE COMPONENT MANUFACTURER'S INSTRUCTIONS PROVIDED IN THEIR LITERATURE.

SOME OF THE PRODUCTS SHOWN IN THIS MANUAL MAY BE OPTIONAL EQUIPMENT NOT INCLUDED OR AVAILABLE WITH YOUR RECREATION VEHICLE. ANY SPECIAL

EQUIPMENT, MODIFICATIONS, OR ADDITIONS MADE BY OR AT THE REQUEST OF THE CUSTOMER, OR ANY SUBSEQUENT OWNER, WHETHER MADE AT THE FACTORY OR IN THE FIELD, ARE NOT COVERED IN THIS MANUAL. WE RESERVE THE RIGHT TO CHANGE THE CONSTRUCTION OR MATERIAL OF ANY PARTS AT ANY TIME WITHOUT INCURRING THE OBLIGATION TO INSTALL SUCH CHANGES ON DELIVERED UNITS.

Your recreation vehicle has had a thorough inspection before it was shipped to the dealer. However, to insure your complete satisfaction, the dealer must perform an inspection of various components and operations based on a pre-delivery inspection list provided. You should take the opportunity to cover the operation of all components of your recreation vehicle with your dealer. This will help make you familiar with the recreation vehicle and its operation, while at the same time providing you with the assurance of everything being in proper working order. A road test by the dealer should be included as part of the pre-delivery inspection. He can then check for and correct any steering problems before you take delivery of the recreation vehicle. After this road test has been completed, front end alignment and/or vibrations will not be covered as part of the new vehicle warranty.

This recreation vehicle has been designed for short term and recreation use. It was not designed to be used as a permanent dwelling or as a rental vehicle. If you intend to use your recreation vehicle as a permanent dwelling or rental vehicle, it could cause your carpet, drapes, upholstery, and interior surfaces to deteriorate prematurely. This premature wear caused by long term or permanent residency may, under the terms of the new vehicle warranty, be considered abnormal and abusive and **COULD REDUCE YOUR WARRANTY COVERAGE**. Should a problem develop for which you need assistance, contact your dealer. If the problem is automotive, the motorhome should be taken to either a chassis manufacturer service center or dealer. If the problem is with an appliance, check the appliance manufacturer's information supplied with the recreation vehicle for information regarding warranty work and/or location of appliance service centers.

If, when traveling, you experience a breakdown or problem while your recreation vehicle is under warranty, and an authorized service center or dealer is not available, contact the dealer you purchased your recreation vehicle from before having the work done at an independent service center. By notifying them, you will know what is covered under the terms of your warranty, as well as making them aware of your problem. **Any parts that require replacement, that are covered under the terms of the warranty should be retained and returned to your local dealer along with your invoice.** This way, they are able to check what has occurred, and also make sure you are properly reimbursed for your expenditures.

Repairs made without prior authorization may be subject to denial or partial reimbursement. Modifications made to the recreation vehicle without proper authorization can result in reduction or loss of warranty coverage. Please make sure to contact your dealer before making such changes.

# SAFETY

## REPORTING SAFETY DEFECTS

The following note is added as a requirement of the National Highway Traffic Safety Administration (NHTSA):

If you believe that your vehicle has a defect which could cause a crash or could cause injury or death, you should immediately inform the National Highway Traffic Safety Administration (NHTSA) in addition to notifying the manufacturer.

If NHTSA receives similar complaints, it may open an investigation, and if it finds that a safety defect exists in a group of vehicles, it may order a recall and remedy campaign. However, NHTSA cannot become involved in individual problems between you, your dealer, or the manufacturer.

There are several ways to contact NHTSA. You may either call the Auto Safety Hot-line toll-free at 1-888-327-4236 (TTY: 1-800-424-9153), or the NHTSA address is; NHTSA, 400 Seventh St, S.W., Washington, DC 20590 or go to their website: <http://www.safercar.gov>. You can also obtain other information about motor vehicle safety from the Hot-line and website.

## SAFETY SYMBOLS

The following safety alert symbols are used throughout this manual to call attention to warnings where possible personal injury or vehicle damage may be involved.



### **DANGER**

**DANGER** indicates an imminently hazardous situation which, if not avoided, will result in death or serious injury.



### **WARNING**

**WARNING** indicates a potentially hazardous situation which, if not avoided, could result in death or serious injury.



### **CAUTION**

**CAUTION WITH EXCLAMATION** indicates a potentially hazardous situation which, if not avoided, may result in minor or moderate injury.

### **CAUTION**

**CAUTION** used without a safety alert symbol indicates a potentially hazardous situation which, if not avoided, may result in property damage.

## **LP GAS SYSTEMS AND APPLIANCE SAFETY REGULATIONS**

The following warnings are posted throughout your recreation vehicle to provide information on LP gas safety. They have been installed not only because of the requirement to do so, but also as a constant reminder to occupants of the recreation vehicle to exercise proper caution when using or being around LP gas appliances and equipment. We are listing them here so that you may study them and make sure that you and your family understand and follow them.

### **WARNING**

**IT IS NOT SAFE TO USE COOKING APPLIANCES FOR COMFORT HEATING. COOKING APPLIANCES NEED FRESH AIR FOR SAFE OPERATION. BEFORE OPERATION:**

- 1. OPEN OVERHEAD VENT OR TURN ON EXHAUST FAN AND:**
- 2. OPEN WINDOW.**

**FAILURE TO COMPLY COULD RESULT IN DEATH OR SERIOUS INJURY.**

This warning label has been located in the cooking area to remind you to provide an adequate supply of fresh air for combustion. Unlike homes, the amount of oxygen supply is limited due to the size of the recreation vehicle, and proper ventilation when using the cooking appliance(s) will avoid dangers of asphyxiation. It is especially important that cooking appliances not be used for comfort heating as **THE DANGER OF ASPHYXIATION IS GREATER WHEN THE APPLIANCE IS USED FOR LONG PERIODS OF TIME.**

Overfilling the LP gas container can result in uncontrolled gas flow which can cause fire or explosion. A properly filled container will contain approximately 80 percent of its volume as liquid LP gas. An 80 percent automatic shutoff has been installed on the LP gas tank which will automatically prevent further filling when the gas volume has reached 80 percent of tank capacity.

### **WARNING**

**This tank is equipped with an automatic valve designed to close at 80% liquid full. Always open 20% fixed liquid level bleeder gauge while filling. Stop filling if liquid appears before valve shuts off.**

**All LP gas is contained under pressure. Due to the dangerous potential of any compressed gas, it is mandatory that the following requirements for the use of this tank be followed: tanks are to be installed, fueled and maintained in accordance with State and local codes, rules, regulations or laws and in accordance with the NFPA Pamphlet 58, Division IV.**

#### **IF YOU SMELL GAS.**

- Extinguish any open flames, pilot lights, and all smoking materials.**
- DO NOT touch electrical switches.**
- Shut off the gas supply at the tank valve(s) or gas supply connection.**
- Open doors and other ventilating openings. (DO NOT USE THE RANGE HOOD)**
- Leave the area until the odor clears,**
- Have the system checked and leakage source corrected before using again.**

- **LP gas regulators must always be installed with the diaphragm vent facing downward. Regulators that are not in compartments have been equipped with a protective cover. Make sure that regulator vent faces downward and the cover is kept in place to minimize vent blockage which could result in excessive gas pressure causing fire or explosion.**

**Portable fuel burning equipment including wood or charcoal burning grills and stoves shall not be used inside the vehicle because they may cause fire or asphyxiation.**

## **FIRE SAFETY**

Fire safety is an important part of owning a recreation vehicle. The following basic rules of fire prevention can help eliminate the possibility of a fire.

Make sure that everyone in your recreation vehicle is familiar with the location of exits, including emergency exit windows should an emergency arise.

- Never store flammable liquids in the recreation vehicle.
- Never leave cooking food unattended.
- Never smoke in bed, and always use an ashtray.
- Never allow children to play with LP gas or electrical equipment.
- Never use an open flame as a flashlight.
- Always repair faulty or damaged wiring and electrical components.
- Never overload electrical circuits.
- Locate and repair LP leaks immediately.
- Keep cooking surfaces clean.
- Don't allow rubbish accumulation.
- Never clean with a flammable liquid.
- Spray fabrics annually with a flame retardant.

### **If a fire does start, make sure to follow basic rules of safety:**

1. Have everyone evacuate the recreation vehicle as quickly as possible.
2. After everyone is clear, check the fire to see if you can attempt to put it out. If it is larger than a small waste basket fire, or the fire is fuel-fed, get clear of the recreation vehicle and have the fire department handle the emergency.
3. **DO NOT** attempt to use water to put out the fire. Water can spread some types of fire, and electrocution is possible with an electrical fire.

If you determine that you can attempt to control the fire using the fire extinguisher, make sure you know how to use it. Read the label on the fire extinguisher, and study the information in this manual to become familiar with the safe operation and maintenance of the extinguisher.



## **FIRE EXTINGUISHER**

### **Underwriter Laboratories classify fires into three types:**

Class A —Fires in wood, paper, fabric, rubber, and certain plastics.

Class B —Flammable liquids such as grease, cooking oils, gasoline, or kerosene.

Class C —Electrical fires started from live electrical wires, from short circuited motors or switches.

The fire extinguisher provided with the recreation vehicle is a chemical type suitable for extinguishing small fires of the class B or C type. Extinguishers are designed to put out a fire in the initial stage, not when it is blazing out of control. If a fire cannot be approached within 10', it is too late to do any good.

To fight a fire with an extinguisher, first remove the tamper tape which covers the discharge push button. The extinguisher does not need shaking. Hold it upright and stand six to ten feet from the fire with a clear path to an exit. Press the button down all the way, aimed at the base of the fire and spray with quick motions from side to side.

Avoid inhaling the dry chemicals. Although nontoxic, they could cause temporary irritation and vomiting. When the fire is out, clean up the area as soon as possible. The dry chemicals are non-corrosive, but some residue may cause surface damage if left too long.

In the case of an electrical fire, disconnect the battery and throw off the main circuit in the unit. It is important that everyone knows where to find the main circuit and how it operates. If the shoreline power cord is connected, disconnect it.

### **To keep a fire extinguisher in operating condition:**

**Check pressure** — monthly or more often. Check the nozzle for obstruction. Press the pin below the nozzle. If it returns and sticks out from the extinguisher, it is operable. If the pin does not come back, discard extinguisher. Refillable models have a pressure gauge to check.

**Tamper tape** — Check the tape to make sure it is intact. DO NOT test the extinguisher. Even a partial discharge may cause leakage, and make it useless when needed.

**Inspection tag** — When checking the extinguisher for pressure, enter the date checked on the inspection tag furnished with the recreation vehicle. Regular inspections will help insure the condition.

## **CARBON MONOXIDE ALARM & SMOKE ALARM (First Alert®)**

### **WARNING**

**This Smoke/Carbon Monoxide Alarm cannot operate without two, AA batteries. Removing the batteries for any reason, or failing to replace the batteries at the end of their service life, removes your protection.**

**NOTE:** Refer to the manufacturer's owner's manual for proper replacement batteries.

This combination Smoke/Carbon Monoxide Alarm has two separate alarms. The CO alarm is not designed to detect fire or any other gas. It will only indicate the presence of CO gas at the sensor. CO may be present in other areas. The smoke Alarm will only indicate the presence of smoke that reaches the sensor. The Smoke Alarm is not designed to sense gas, heat or flames.

During normal operations the Power/Smoke LED flashes Green once per minute, and the CO LED is off.

## PROGRAMMING THE ALARM

**NOTE:** Refer to the Combination Carbon Monoxide & Smoke Alarm User's Manual within your Owner's Packet for detailed setup information.

## TESTING PROCEDURE

### **WARNING**

Never use an open flame of any kind to test this unit. The built-in test switch accurately tests the unit's operation as required by Underwriters Laboratories, Inc. (UL).

**DO NOT** stand close to the alarm when the horn is sounding. Exposure at close range may be harmful to your hearing. When testing, step away when the horn starts sounding.

It is important to test this unit before every trip and every week to ensure it is working properly. Using the test button is the recommended way to test this Smoke/CO Alarm.

You can test this Smoke/CO Alarm two ways:

1. Manually: Press and hold the Test/Silence button on the alarm cover until alarm voice says "Testing" (typically 3-5 seconds).
2. Using Your Remote Control: Standing no further than 20 feet (6 meters) away from the Smoke/CO Alarm, aim the IR remote at the alarm and press the CHANNEL or VOLUME button until alarm voice says "Testing".

If the alarm does not respond to your remote control, there may be an obstruction between you and the alarm, you may be standing too far away, or your remote control may not be compatible.

During testing, you will see and hear the following sequence.

- The alarm voice will say "Testing". The horn will sound 3 beeps, pause, 3 beeps. The alarm voice will say "Warning, evacuate smoke in location. Evacuate." The Power/Smoke

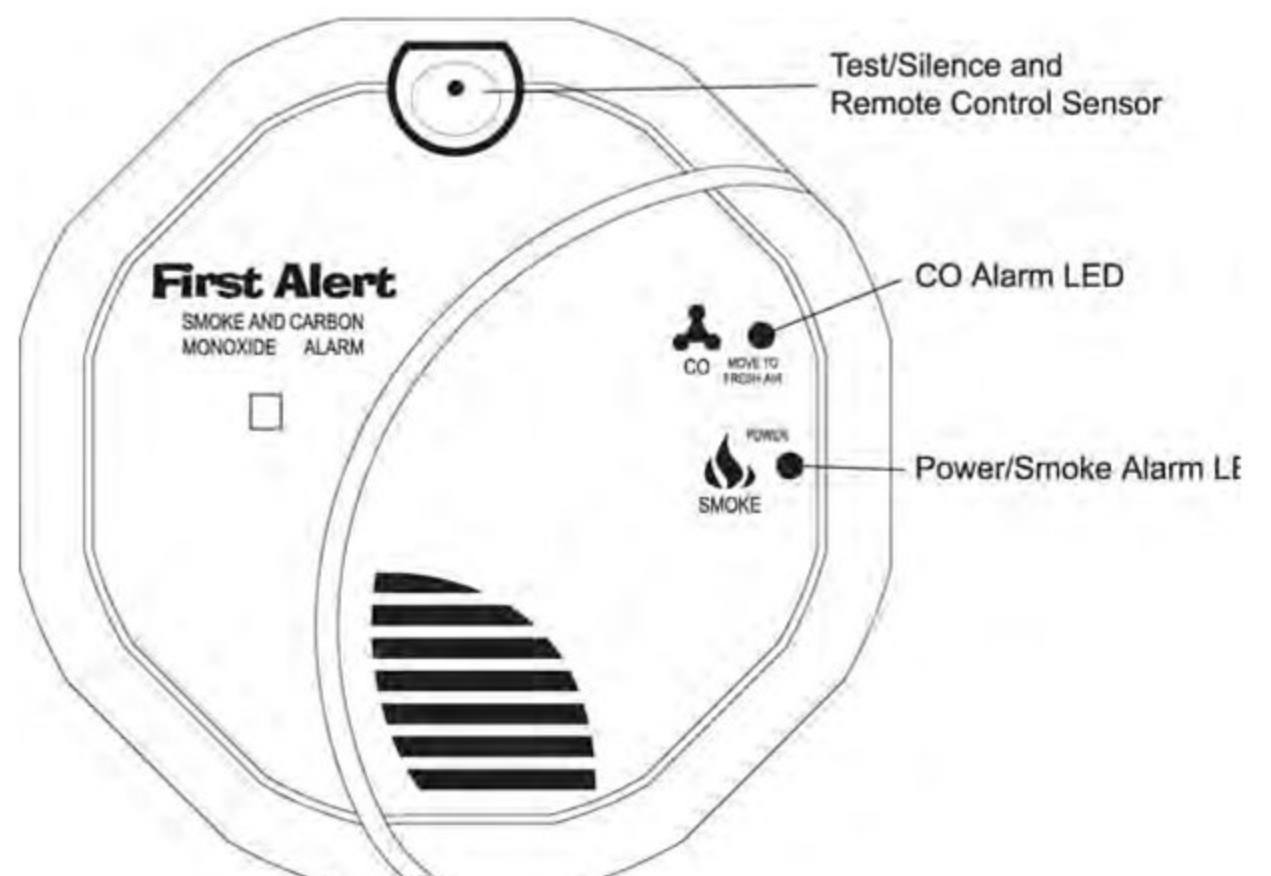

LED flashes Red and the CO LED will be off.

- Next the Horn will sound 4 beeps, pause, 4 beeps. The alarm voice will say “Warning, evacuate carbon monoxide in location. Evacuate”. The Power/Smoke LED will be off and the CO LED flashes red.

**Note:** *If the unit does not alarm, make sure the batteries are correctly installed, and test again. If the unit still does not alarm, replace it immediately.*

## CARBON MONOXIDE SAFETY PRECAUTIONS

### **WARNING**

**DO NOT** alter or modify any component of the exhaust system at any time. Inspect the exhaust system at regular intervals for damage. If you suspect or locate damage to the system, have it repaired immediately.

**Never sleep while the engine is running. Be aware of carbon monoxide poisoning and its symptoms: Dizziness, Severe Headache, Vomiting, Weakness, Sleepiness, Muscular Twitching, and Throbbing in Temples.** If anyone in the motorhome experiences any of these symptoms, shut off the engine, and immediately go outside into fresh air. Get medical attention as soon as possible.

**Do not operate the generator while sleeping. You would not be aware of exhaust entering the recreation vehicle, or alert to symptoms of carbon monoxide poisoning.**

Carbon Monoxide cannot be seen or smelled and can kill you. If alarm sounds: Turn off appliances, as well as other sources of combustion at once (furnace, water heater, stove, motorhome, automobile, etc.) and call the fire department. Get fresh air into the premises or vehicle. Have the problem corrected before starting any appliances or the vehicle.

Never run the generator or the engine unless you are sure that exhaust gases will be safely dispersed into the atmosphere. Always be sure that tail pipes remain unblocked and windows near the exhaust are closed.

## MAINTENANCE

The following maintenance steps should be taken to ensure proper function of the detector.

- Test the detector at least once per week.
- Clean the detector at least once a month; gently vacuum the outside of the detector using the vacuums soft brush attachment.
- If detector becomes contaminated by excessive dirt, dust and/or grime, and cannot be cleaned to avoid unwanted alarms, replace the unit immediately.

### **CAUTION**

**Never use water, cleaners or solvents to clean the detector.**

**NOTE:** *For battery maintenance and replacement procedures, refer to the manufacturer’s owner’s manual.*

## **LP GAS DETECTOR**

The LP Gas Leak Detector is powered at all times when the coach battery disconnect switch is in the ON position. When power is supplied to the detector the green indicator light will illuminate. After 60 seconds, the detector will begin monitoring the air in the motorhome for combustible vapors. The propane you use to cook, refrigerate, and heat is combustible. Should a leak occur, the detector will produce a pulsating alert sound when the gas reaches the detector. This alert will continue to sound until the gas has dissipated or until the reset button is pressed. When the alert sounds, open all doors and major windows to air out the motorhome and turn the gas off at the tank. Do not reenter the motorhome until the alert stops sounding. If the alert sounds a second time after the gas is turned back on, leave the gas off and have a qualified LP Gas Dealer or RV Service Center make the necessary repairs. The reset button only stops the alert from sounding for 60 seconds. This device is intended for detection of LP Gas ONLY.

### **HOW TO TEST**



**Never check for leaks with an open flame. The scent of LP Gas (a garlic-like odor) is actually ethyl mercaptan, an additive that allows you to detect the presence of a leak, since LP Gas is naturally odorless. Do not rely upon being able to detect the smell of the gas, as the odor may fade.**

Simply press the TEST switch any time during the warm-up cycle or while in normal operation. The LED should flash red and the alarm should sound. Release the switch. This is the only way you should test your detector. The test feature checks the full operation of the detector. If this detector does not test properly return it immediately for repair or replacement.

**NOTE:** *This test procedure should be repeated every week or every time the motorhome is taken on a trip, whichever occurs first. Call the detector manufacturer, if you have any questions about the LP Gas Detector.*

### **CHECKING THE LP GAS SYSTEM FOR LEAKS**

Road vibration can loosen LP Gas fittings. It is important to check the LP system for leaks at least every 5,000 miles, and whenever the tank is filled. It is also a good idea to have the entire LP Gas system checked annually by a qualified LP Gas service representative.

Use the following steps when checking the system for leaks:

1. Open all the windows and vents.
2. Open the gas tank service valve.
3. Use non-ammoniate, non-chlorinated soap solution, or an approved leak detection solution on all line connections (ammoniate soap solutions can cause cracking on copper or brass lines and fittings).
4. If a leak is detected, tighten the connection with two open end wrenches until bubbling stops. DO NOT over tighten, or use excessive force. If the leak continues, contact the recreation vehicle dealer, or a qualified LP Gas service representative to have an 11" Water Column Test performed.

## ABOUT THE LP GAS DETECTOR

Liquid Propane Gas (LP Gas) is heavier than air and will settle to the lowest point which is generally the floor of the coach. The detector is also sensitive to other fumes such as hair spray of which most contain butane as the propellant. Butane, like propane, is heavier than air and will settle to the floor level where it will be detected. When this occurs, press the reset button to stop the alert sound for 60 seconds.

Other combustibles which will be detected include alcohol, liquor, deodorants, colognes, perfumes, wine, adhesives, lacquer, kerosene, gasoline, glues, most of all cleaning agents and the propellant's of aerosol cans. Most are lighter than air in their vapor state and will only be detected when the coach is closed up. Glues and adhesives may exhaust hydrocarbon vapors for months after they are applied. They are easily activated by high temperatures.

The LP Gas Detector is powered by the motorhome coach batteries and/or the converter. It draws less current than drawn by one instrument panel lamp. The detector will operate properly until the battery is drained down to 10 volts (a low battery condition is 10.4 volts). If the power source (battery and/or inverter) is disconnected, or if the power is otherwise interrupted, the detector will not operate.

The LP Gas Detector has a self check circuit which runs at all times when the detector is powered. In the event that the circuitry fails, a failure alarm will sound. It is a continuous series of short beep tones between long intervals and is distinctively different from the alert sound.

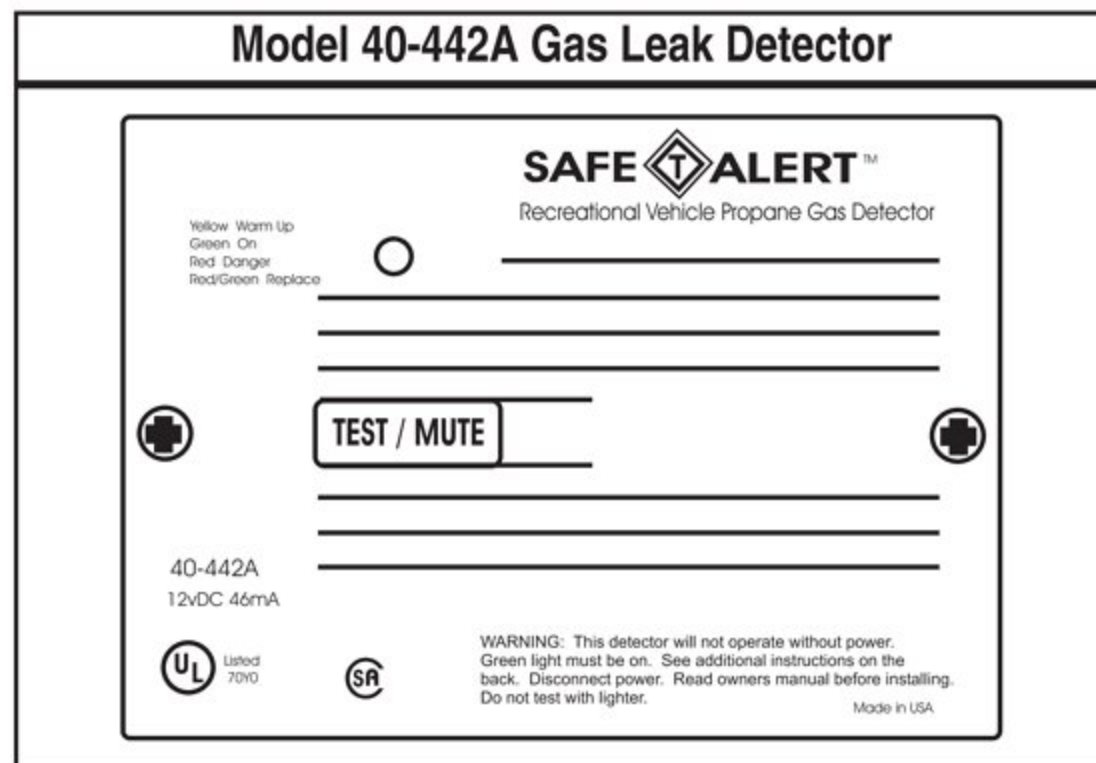

## MOST COMMON CAUSES OF APPARENT MALFUNCTION

- **New Coach Odor:** The glues and other materials used in manufacturing the coach produce vapors which may be detected when the coach is closed up on a warm day. Air out the coach thoroughly.
- **Keeps Beeping:** The gas detector beeps about once every minute, even when it is turned off. The problem is a weak battery in the smoke detector which causes the smoke detector to produce short beeps which sound similar to the alert sound of the LP Gas Detector. This is a high pitch tone and bounces off the walls, making its location very hard to pinpoint. If the sound is not coming from the LP Gas Detector identify the source and refer to the sources section in this manual for means of repair.
- **Hair Spray Triggers the Detector:** Most aerosol hair sprays use butane gas as the propellant. Butane, like propane, is heavier than air and will settle to the floor level where it will be detected. The detector is doing its job as butane is combustible.
- **Other Gases:** Other gases which can cause the detector to respond with an alert include the vapors from any fuel, liquor, alcohol, deodorants, colognes, perfumes, wine, adhesives, lacquer, and most cleaning agents.

- **Slow Beep Rate:** This could be the failure alarm and will occur in the event that the circuitry fails. It is a continuous series of short beep tones between long intervals and is distinctively different from the alert sound.
- After reviewing the above, if the problem still exists, contact MTI Industries for assistance.

**NOTE:** The LP Gas Detector enters a cleaning and initializing mode every time it is powered. If turned off for less than 15 minutes, the LP Gas Leak Detector may produce several short “chirps” within the first 80 seconds of operation. This is normal.

## **SERVICE**

See your Four Winds Dealer or a qualified LP Gas Service Center should service be required. If they are not familiar with this product, have them call the detector manufacturer for assistance. If service is not available in your area, call MTI Industries.

## **SEAT BELTS**

### **WARNING**

**Do not occupy beds or any other seats that are not equipped with safety seat belts while the motorhome is in motion. Do not use a seatbelt on more than one person.**

All occupants must be furnished with and use seat belts while the motorhome is moving. However, it is not intended for all seats to be simultaneously occupied while the vehicle is in motion without regard to the total loaded weight of the vehicle.

## **SEATBELT OPERATION:**

### **WARNING**

**Pilot & co-pilot seats must be locked in a forward facing position with seat belts fastened while the motorhome is in motion. Avoid seat rotation while in transit.**

**The sleeping accommodations in this vehicle are designed for occupancy only while the vehicle is parked. All occupants in this vehicle must be seated at a designated seating position and must wear seat belts at all times while this vehicle is in motion.**

**Safety belts and seats can become hot in a vehicle that has been closed up in sunny weather; they could burn a small child. Check seat covers and buckles before you place a child anywhere near them.**

Insert the belt tongue into the proper buckle (the buckle closest to the direction the tongue is coming from) until you hear a snap and feel it latch. Make sure the tongue is securely fastened in the buckle.

Adjust the belt to the proper position; snug and as low as possible around the hips, not around the waist.

To unfasten, push the release button and remove the tongue from the buckle.

## MAINTENANCE:

### **WARNING**

**Failure to inspect and if necessary replace the safety belt assembly under the above conditions could result in severe personal injuries in the event of a collision.**

Inspect the safety belts periodically to make sure they work properly and are not damaged. Inspect the safety belts to make sure there are no nicks, tear or cuts. Replace if necessary. A qualified service technician should inspect all safety belt assemblies after a collision. Four Winds International recommends that all safety belt assemblies used in vehicles involved in a collision be replaced.



## CHILD RESTRAINTS:

### **WARNING**

**Rear-facing child seats or infant carriers should never be placed in the front seats.**

**Never let a passenger hold a child on his or her lap while the vehicle is moving.**

You are required by law to use safety restraints for children in the U.S. and Canada. If small children (generally children who are four years old or younger and who weigh 18 kg [40 lbs] or less) ride in your vehicle, you must put them in safety seats made especially for children.

**NOTE:** Check your local and state or provincial laws for specific requirements regarding the safety of children in your vehicle.

**NOTE:** Always follow the instructions and warnings that come with any infant or child restraint you might use.

If the child is the proper size, restrain the child in a safety seat. Children who are too large for child safety seats (as specified by your child safety seat manufacturer) should always wear safety belts.

If the shoulder belt portion of a combination lap and shoulder belt can be positioned so it does not cross or rest in front of the child's face or neck, the child should wear the lap and shoulder belt.

## BOOSTER SEATS:

### **WARNING**

**Never use pillows, books, or other objects to boost a child.**

**Do not leave children, unreliable adults, or pets unattended in the motorhome.**

Children outgrow a typical convertible or toddler seat when they weigh 40 pounds and are around 4 years of age. Although the lap/shoulder belt will provide some protection, these children are still too small for lap/shoulder belts to fit properly, which could increase the risk of serious injury.

To improve the fit of both the lap and shoulder belt on children who have outgrown child safety seats, Four Winds International recommends use of a belt-positioning booster.

Booster seats position a child so that safety belts fit better. They lift the child up so that the lap belt rests low across the hips and the knees bend comfortably. Booster seats also make the shoulder belt fit better and more comfortably for growing children. Follow all instructions provided by the manufacturer of the booster seat.

**NOTE:** Check your local and state or provincial laws for specific requirements regarding the safety of children in your vehicle.

**NOTE:** Seat belts have been provided at most seating locations within your vehicle to allow the user the flexibility and convenience to choose which seat location they would like to occupy. However, it is not intended for all seats to be simultaneously occupied while the vehicle is in motion without regard to the total loaded weight of the vehicle. **DO NOT EXCEED THE CARRYING CAPACITY OF THIS VEHICLE.**

## **EGRESS WINDOW**

An egress window is designated for use as an exit in the case of an emergency. Inside the motorhome the egress window is easily identified by the red locking handles. It is also marked as an "EXIT". The glass slider in the egress window operates the same as all other windows;

- To open the egress window, pull the latch handles towards you and then push outward on the window.
- To close the egress window, pull the window closed and push the handles to lock the window in place.

**NOTE:** The egress window should be opened twice a year to ensure proper operation. Over time, the rubber seal will tend to stick to the egress window. Occasional operation will help prevent the rubber seal from sticking.

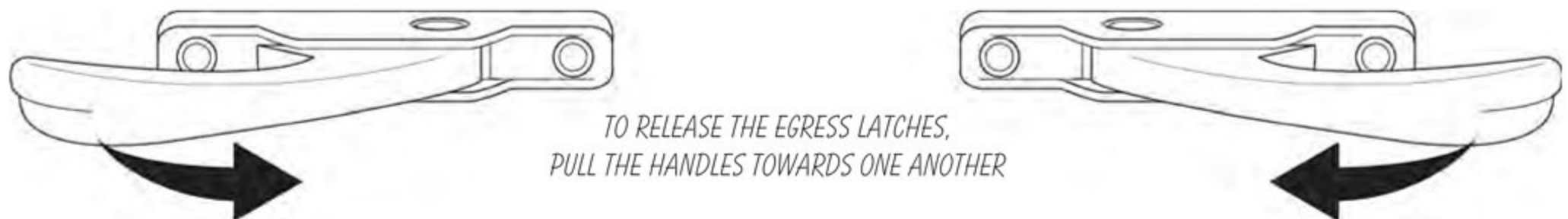

## **MOLD**

### **What are molds?**

Molds are microscopic organisms that naturally occur in virtually every environment, indoors and out. Outdoors, mold growth is important in the decomposition of plants. Indoors, mold growth is unfavorable. Left unchecked, molds break down natural materials, such as wood products and fabric. Knowing the potential risks is important for an owner to protect their investment.

### **What factors contribute to mold growth?**

For mold growth to occur, temperatures, indoor or outdoors, must be between 40° and 100° Fahrenheit and also have a source of moisture, such as humidity, standing water, damp materials, etc. Indoors, the most rapid growth occurs with warm and humid conditions.



### **How can mold growth be inhibited?**

By controlling relative humidity, the growth of mold and mildew can be inhibited. In warm climates, use of the air conditioner will reduce the relative humidity. Vents are located in the bathing and cooking areas and constant use is advised during food preparation and bathing, even during cold weather. Additionally, opening a window during these activities will assist in ventilation. In extremely humid conditions, the use of a dehumidifier can be helpful. For more information see Care and Maintenance Section 12 Page 11.

## **CHEMICAL SENSITIVITY**

After you first purchase your new recreational vehicle and sometimes after it has been closed up for an extended period of time you may notice a strong odor and chemical sensitivity. This is not a defect in your recreational vehicle. Like your home, there are many different products used in the construction of recreational vehicles such as carpet, linoleum, plywood, insulation, upholstery, etc. Formaldehyde is also the by-product of combustion and numerous household products, such as, some paints, coatings and cosmetics. However, recreational vehicles are much smaller than your home and therefore the exchange of air inside a recreational vehicle is significantly less than a home. These products, when new or when exposed to elevated temperatures and/or humidity, may “off-gas” different chemicals, including formaldehyde. This off-gassing, in combination with the minimal air exchange, may cause you to experience irritation of the eyes, nose, and throat and sometimes headache, nausea, and a variety of asthma-like symptoms. Elderly persons and young children, as well as anyone with a history of asthma, allergies, or lung problems, may be more susceptible to the effects of off-gassing.

### **FORMALDEHYDE**

Most of the attention regarding chemical off-gassing surrounds formaldehyde. Formaldehyde is a naturally occurring substance. It is also a key industrial chemical used in the manufacture of the numerous consumer products which we referred to above and used in the construction of recreational vehicles. Trace levels of formaldehyde are also released from smoking, cooking, use of soaps and detergents such as carpet shampoos, cosmetics, and many other household products. Some people are very sensitive to formaldehyde while others may not have any reaction to the same levels of formaldehyde. Amounts released decrease over time.

### **VENTILATION**

To reduce or lessen exposure to chemicals from off-gassing it is of utmost importance that you ventilate your recreational vehicle. Ventilation should occur frequently after purchase and at times when the temperatures and humidity are elevated. Remember off-gassing is accelerated by heat and humidity. Open windows, exhaust vents, and doors. Operate ceiling and/or other fans, roof air conditioners, and furnaces and use a fan to force stale air out and bring fresh air in. Decreasing the flow of air by sealing the recreational vehicle increases the formaldehyde level in the indoor air. Please also follow the recommendations contained in Chapter 12 page 12 regarding tips to avoid condensation problems. Many of the recommendations contained in Chapter 12 will assist in avoiding exposure to chemicals that off-gas.

**NOTE:** We recommend that you **do not smoke inside your recreational vehicle**. In addition to causing damage to your recreational vehicle, tobacco smoke releases formaldehyde and other toxic chemicals.

**NOTE:** If you have any questions regarding the health effects of formaldehyde, please consult your doctor or local health department.

**NOTE:** Chemical off-gassing is not a “defect” in your recreational vehicle and is not covered by the Four Winds International Limited Warranty. Please follow the recommendation in this section to address this concern.

## **MOTORHOME/CARGO VAN SAFETY (Fun Movers)**

### **WARNING**

Do not occupy the storage area when the vehicle is in motion, when the engine or generator is running or when parked near a carbon monoxide source. Always keep the door between the living area and storage area closed when the above conditions exist. Frequently check the C.O. detector for proper operation.

## **STORING & TRANSPORTING VEHICLES WITH INTERNAL COMBUSTION ENGINES**

### **DANGER**

**DANGER:** Any motorized vehicle or any motorized equipment powered with flammable liquid can cause fire and explosion or asphyxiation if stored or transported within the recreation vehicle. To reduce the risk of fire, explosion or asphyxiation:

1. Do not allow passengers to ride inside the internal combustion engine vehicle storage area while vehicles are present.
2. Do not allow occupants to sleep in the vehicle storage area while vehicles are present.
3. Doors and windows in walls of separation (if installed) must be closed while vehicles are present.
4. Run fuel out of engine after shutting off fuel at the tank.
5. Do not store or transport supplementary motor fuel within this vehicle.
6. Ventilate the interior of the vehicle to reduce the risk of fire, explosion, or asphyxiation.
7. Do not operate gas appliances, pilot lights, or electrical equipment when motorized vehicles or motorized equipment are inside vehicle.
8. Do not operate motorized vehicles while the rear door is closed.

**FAILURE TO COMPLY COULD RESULT IN AN INCREASED RISK OF FIRE, EXPLOSION, ASPHYXIATION, DEATH OR SERIOUS INJURY.**

Loading an internal combustion engine or other materials inside of cargo storage area will affect the weight distribution of your motorhome. Adding weight to the unit behind the rear axle will reduce weight to the front axle. This may adversely affect handling of motorhome while in transit. Adding the weight behind the rear axle also adds to the weight load on the rear axle. Do not overload the rear axle weight rating.

Cohabiting with an internal combustion engine vehicle can be hazardous to your health. Fumes from fuel can cause fire, explosion, or asphyxiation.

## **FUN MOVER TIE-DOWN SAFETY INSTRUCTIONS (CORE-TRAX)**

### **CAUTION**

Read and follow these instructions carefully. Inspect product before each use. **DO NOT USE** product if deformed, damaged, or not securely installed. Avoid contact with objects or chemicals that may damage or weaken product. Product is not designed for use as a personal restraint or for towing. User is responsible for determining product's suitability for a particular purpose. Core Marketers Group, Inc. and Four Winds International are not responsible for damage or injury caused by improper use of products.

The correct method for securement of an ATV or motorcycle is to use two Ratchet straps in front and two on the rear. Additionally the front wheel must be chocked. The trax are not intended nor designed to control the G-forces applied during stopping, turning or accelerated loads.

#### **TESTED LOAD VALUES Load Lock & Trax Together**

- Load testing - direct pull of Load Lock in the Core-Trax™ tie-down system: (breaking strength) 1,500 pounds per Load Lock.
- Multiple attachment areas available along the trax system.

**Note:** When possible attach the load lock(s) nearest the mounting hardware. This will allow for the safest use.

#### **Definition #1: Working Load**

- Maximum cargo weight a tie-down can **safely** be used for.

#### **Definition #2: Breaking Strength**

- Maximum tested cargo weight a tie-down can handle **before partial or complete failure**.
- The industry standard calculation for **Working Load** is 1/3 of the Breaking Strength.
- I.E. Core-Trax™ with a combine Trax/Load Locks tested breaking strength of 1,500 lbs. has a Working Load of 500 lbs. per Load Lock.

Wheeled loads; use a combination of wheel chocks and set brakes in conjunction with the use of all tie-down product.

#### **SELECTING YOUR TIE-DOWN**

- Use two (2) minimum 500 lb. Working Load\* tie-downs per motorcycle up to 500 lbs.
- Use four (4) tie-downs for ATVs and motorcycles weighing 500 to 1,000 lbs.
- Add two more for every 500 lbs. thereafter (Core-Trax uniquely supports this method by making available multiple locking positions).
- For other applications, a good rule is that each tie-down should have a Working Load equal or greater than the weight of your cargo. Wheeled loads; use a combination of wheel chocks and set brakes in conjunction with the use of all tie-down products.

**NOTE:** \* These are only suggestions; please contact your local department of transportation for their recommendations.

To obtain warranty service for the Core-Trax product, please call (951) 699-1618. Proof of purchase is required. Shipping expenses are the buyer's responsibility.

# IDENTIFICATION & TRAVEL PREP

## **RECREATION VEHICLE SERIAL NUMBER, DECALS, AND DATA PLATES**

The recreation vehicle serial number label is mounted on the inside wall next to the driver's seat on a Class A Motorhome and on the inside of the driver's door post on a Mini Motorhome. Refer to the chassis owner's manual for the location of the chassis vehicle identification number on all motorized recreation vehicles.

**IMPORTANT:** Always give model, year, and the V.I.N. number information when ordering parts. Also, we recommend that you keep a copy of this information separate from the recreation vehicle in the event theft or vandalism requires you to supply a copy to the authorities.

Decals and data plates used throughout the recreation vehicle aid in its safe and efficient operation; others give service instructions. Read all decals, data, and instruction plates before operating your recreation vehicle.

When any decal, data, or instruction plate is damaged, painted over, removed, etc.; it should be replaced.

MANUFACTURED BY: INC. VEH. MFG. BY:	FOUR WINDS INTERNATIONAL	MODEL: SERIAL:	Offline: Received:
GWWR:	<u>KG(LB)</u>	TIRES	RIMS
GAWR FRONT:			
GAWR INTERM:			
GAWR REAR:			
THIS VEHICLE CONFORMS TO ALL APPLICABLE U.S. FEDERAL MOTOR VEHICLE SAFETY STANDARDS IN EFFECT IN:		TYPE: MULTI PASSENGER VEHICLE	

## **MANUFACTURER'S WARRANTIES**

The following list of components has been compiled to help you know which products on your recreation vehicle may have their own warranties. If you have any of these components on your recreation vehicle, be sure to check the literature supplied by the manufacturer to see if they require that you register your purchase with them to validate their warranty. We recommend that you send the various warranty registration cards immediately before any time constraints on registration expire. Manufacturer's literature is contained in a separate packet furnished with the owner's manual on newly delivered units. Only those products and options which are on your recreation vehicle will be included in this packet. You should go over this literature with your dealer during the pre-delivery inspection. Any shortages of literature should be reported to the dealer at that time.

<b>APPLIANCES</b>		
Air conditioner (roof)	Water heater	Awnings
Furnace	Televisions	Home theatre system
Range	VCR/VCP	DVD player
Range hood	Radio/CD Player	Satellite system
Microwave oven	Ice maker	Coffee maker
Refrigerator	GPS	
<b>ELECTRICAL</b>		
120/12V converter	LP leak detector	Carbon Monoxide Detector

Generator	Battery	Smoke detector
GFCI receptacle		
<b>WATER &amp; DRAINAGE</b>		
Toilet	Water pump	Water faucets
<b>LP GAS</b>		
Regulator	Gas tank	Gas leak detector
<b>CHASSIS</b>		
Air conditioner	Back up monitor	Batteries
Cruise control	Leveling jacks	

## ***FIRST SHORT TRIPS***

After becoming familiar with the vehicle's systems and going through test runs on items such as use of Liquid Petroleum Gas (LPG), it is time to take one or two short trips, including spending the night at a campground not too distant from your home . . . you might want to go back and get something you forgot or didn't know you needed.

These short trips can be considered "shake down cruises" or "familiarization flights". The experience gained on these short trips will be worth the time and money to you . . . time and money spent either needlessly, taking something that takes up space or the time and money spent trying to obtain an item you hadn't counted on needing prior to leaving home base on an extended trip miles from home and in unfamiliar surroundings.

It is understandably upsetting having to purchase a needed item on the road knowing that one is sitting at home unused.

Not all RVers need the same equipment or supplies. For one thing, the United States presents a wide variety of climate and terrain. For another, personal needs and tastes come into play.

Our suggestion is to take a weekend trip to a camp location that is close to home. Be sure to have a note pad and pen available to write down items you feel will be needed in the future as well as equipment that you may need to learn more about.

Also, if most of your trips will be made in the summer and your shake down trip is made during some other season, there will be adjustments to take into consideration. Talk to other RVers and learn from their experiences.

If you are an experienced RVer it is still necessary to thoroughly read this manual. New and improved equipment is coming onto the market every day and, at the same time, not every motorhome manufacturer builds vehicles the same way.

This manual is packed with detail, however, after you have worked with the various systems during a couple of shake down trips, you will be capable of conducting a pre-trip check in less time than it takes to read this manual.

**BECAUSE OF DIFFERENT RV MODELS FOUR WINDS INTERNATIONAL MANUFACTURES AND THE NUMBERS OF OPTIONS AVAILABLE, YOUR RV MAY NOT INCLUDE ALL OF THE SYSTEMS DESCRIBED IN THIS MANUAL.**

## **TRAVEL PREPARATION**

Like any vacation trip, preplanning will pay big dividends. A checklist is often helpful.

In addition to routine trip preparations such as having newspaper delivery stopped and mail held at the post office, there are now more vehicle-related preparations than there were with the old family car.

### **CHASSIS CHECKS**

As with any vehicle, the RVer needs to check the automotive systems prior to a trip. They include:

#### **Under Hood;**

- Fluid Levels (oil, power steering, radiator, transmission, windshield washer, etc.)
- Belts (tension and condition)
- Battery (electrolyte level if applicable, connections, charge)
- Hoses (clamps tight, condition, leakage)
- Seals, Gaskets (leaks)

#### **Exterior;**

- Tire pressure/condition and lug nut torque
- Spare tire, rim condition, and tools-including jack
- Headlights, running and safety marker lights including brake and turn signal and also any trailer light connections
- Rear view mirror adjustment
- Security of any auxiliary equipment such as TV and CB antenna, awning, etc.
- Windshield wiper blade condition
- Generator compartment
- Fresh and waste water connections/drains and supplies such as high pressure hose
- Liquid Petroleum Gas compartment/tank **Under Vehicle;**
- Drive train condition, specifically leaks (U-joints, differential, transmission)
- Brakes including lines, pads/shoes, seals
- Engine area for pan gasket or other leaks
- Anything unusual hanging or tangled with road debris such as tree limbs
- Tank condition (gas, fresh water, waste water)

- Wheel cylinder seals (leakage)

### **Inside Driver's Compartment:**

- Check operation of all systems, including: Wipers; Windshield; Horn; Brakes; Emergency Brake; Steering; Transmission; Heater; Defroster; Air Conditioner and Seat Adjustment.
- Also idle engine long enough to check cooling system (temperature gauge/light) and Alternator (charging) operation. Be sure to turn on headlights and climate controls to see if alternator handles the additional drain on electrical system (should not show discharge).

### **RV System Check:**

As an RVer you now have the added responsibility to prepare the living quarters for a trip. Preparations include:

- Filling fresh water tank. In winter be sure that system is freeze protected.
- Check list of food, utensil and clothing needs and to save weight and space do not take more than two or three days food supply.
- Check storage of all items, making sure that everything is secured and that heavy items are stored low so they do not fall.
- Check operation of stove and refrigerator.
- Check paper work such as Owner Registration Card, vehicle registration, proof of insurance, driver's license and names/phone numbers of individuals you are to contact during the trip, such as Ranger Stations.



**DANGER**

**Pay careful attention to where and what type of flammable materials you store. Certain storage areas are clearly labeled DO NOT STORE COMBUSTIBLE MATERIALS. Examples of spark-producing areas, depending upon RV model, are: base kitchen cabinets, front dinette base, exterior refrigerator service compartment, as well as refrigerator cabinet. *Please use your discretion as to what potentially dangerous products your RV contains while traveling. Be sure all canister and bottle tops are secure and leak-free.***

# AUTOMOTIVE OPERATIONS & PROCEDURES

## **GENERAL INFORMATION**

**NOTE:** All issues regarding chassis warranty, parts and service should be directed to the Chassis Manufacturer.

The chassis is the foundation and heart of your motorhome. With proper care and maintenance, it will provide years of service, and many miles of enjoyable travel.

You as owner, are the key to keeping your vehicle in good operating condition, as well as being responsible for taking the proper precautions when attempting any maintenance or repair activities. If you are not sure what action to take, or uncomfortable with performing a maintenance or repair function, contact your dealer, or a designated chassis manufacturer servicing dealer (check information supplied by chassis manufacturer for a servicing dealer near you).

**NOTE:** Make sure to read all chassis information supplied by the chassis manufacturer, paying particular attention to precautionary notes and warnings, as well as all maintenance procedures and schedules.

**NOTE:** Your motorhome may have a Event Data Recorder. Refer to your chassis owners manual for further details.

## **NEW VEHICLE BREAK IN**

Special procedures or schedules for breaking in your new motorhome are minimal. Make sure to follow the recommendations as outlined in the chassis owner's manual to ensure proper future performance and economy.

## **FOOT SERVICE BRAKES**

Operation and maintenance of the brake system is covered in the chassis owner's manual. Always be sure to keep your brakes in proper working condition, following the service schedule in the chassis literature, and the recommendations of your chassis service representative.

## **WHEELS AND TIRES**

Your motorhome tires play an important role in the load carrying capacity of the vehicle. To ensure good tire life, check tires often. Inspect the general condition of the tires, as well as the air pressure.

Always check the air pressure when the tire is cold. Tires that are hot from traveling will show higher pressures. The maximum tire pressure and the load carrying capacity of the tire is imprinted on each tire sidewall, as well as on the vehicle serial number I.D. tag. Always inflate your tires to their correct pressure. Do not over- or under-inflate. Under-inflated tires will run hot, shorten the tire's life, and decrease the motorhome's safe load limit. Over-inflated tires will cause a rough and bouncing ride that can damage motorhome components or cargo. It is a good idea to always carry an accurate tire pressure gauge in the motorhome to make these checks. If



pressure checks indicate a tire is losing air, check for signs of valve leakage, penetration, or wheel and rim damage.

The way you drive can have a significant effect on the wear and life of tires also. High speeds, unusual use of the brakes, taking corners too quickly, quick starts, and surfaces in poor condition all can contribute to the early wear and failure of your tires. When you drive on surfaces with holes or rocks and other loose objects that can damage tires and cause misalignment, make sure to reduce speed and drive carefully.

If you notice damage to a tire such as a bulge, uneven wear, or damage by a foreign object or the road, have it inspected and repaired or replaced as needed. Remember that tires should be taken to an authorized tire repair facility.

On dual wheels, the outer tire receives additional wear while turning, due to the dragging and skidding effect that is produced by the difference in the turning radius between inner and outer tires.

**NOTE:** Cold tire inflation pressure is defined as a tire that has not been used for three or more hours, or has been driven less than one mile. Tire inflation pressure of a hot tire may show an increase of as much as 6 psi over a cold tire. Never bleed air out of a warm tire.

## **TIRE INFLATION INFORMATION**

### **WARNING**

**An inflated tire and rim can be very dangerous if improperly used, serviced or maintained. To avoid serious injury, never attempt to re-inflate a tire which has been run flat or seriously under-inflated without first removing the tire from the wheel assembly for inspection. Do not attempt to add air to tires or replace tires or wheels without first taking precautions to protect persons and property.**

The Ford F53 motorhome chassis are equipped with a tire that is an all-steel radial. All-steel radial tires utilize steel cords in the sidewalls, and also require increased inflation pressures of up to 95 psi. As such, they cannot be treated like normal light truck tires. Tire service, including adjusting tire pressure, must be performed by personnel trained, supervised and equipped according to Federal Occupational Safety and Health Administration (OSHA) regulations. For example, during any procedure involving tire inflation, the technician or individual must utilize a remote

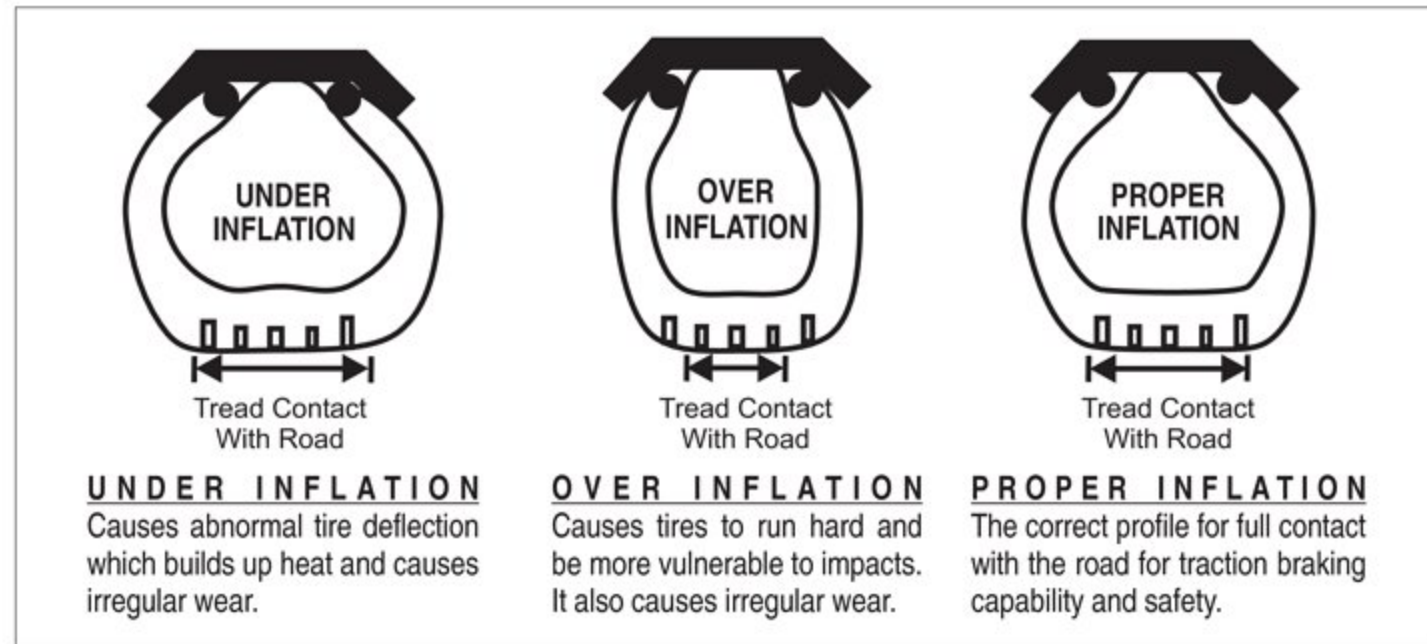
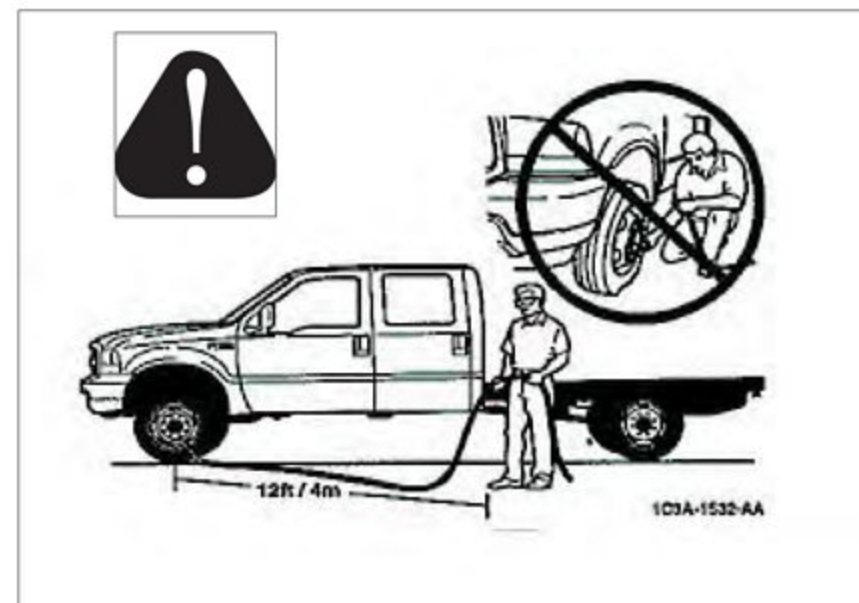

inflation device, and insure that all persons are clear of the trajectory area. Consult with an authorized chassis service center for additional information. See your chassis owner's manual.

## **CHANGING A TIRE**

### **CAUTION**

**When replacing a tire, make sure to replace it with a tire of the same size and specifications.**

If you experience a flat tire on your recreation vehicle, it is recommended that you have qualified personnel with the proper equipment handle the problem. Changing tires on large vehicles such as motorhomes requires special tools and knowledge that most people do not possess. Physical limitations are also a factor in the ability of an individual to change a flat tire. Because of the size and weight of recreation vehicle wheel and tire assemblies, as well as the amount of torque needed to tighten wheel nuts securely, it is best to call in a professional. It is for this reason a jack has not been included with the motorhome. Make sure that the wheel nuts have been tightened to the proper torque as outlined in the chassis manufacturer's owner's manual.

## **WHEEL NUT TORQUE**



### **WARNING**

**Failure to re-tighten wheel nuts as required could allow wheels to come off while the vehicle is in motion, causing loss of control and possible collision.**

It is also important to have the wheel nuts checked regularly to make sure they have not loosened during travel. Follow the schedule for regular wheel nut torque checks as outlined in the chassis manufacturer's owner's manual. If you suspect that wheel nuts have loosened at any time, have them checked and torque to proper limits immediately.

If you suspect or notice wheel stud bolts are cracked or broken, they must be replaced, along with adjacent bolts that have probably also been weakened due to additional stress placed on them.

You, as the owner of the motorhome need to make frequent inspections of wheels and tires, looking for signs of wear or damage. You also need to avoid abusive driving habits, such as hitting curbs or chuck holes at high speed which can damage tires and wheel components.

***NOTE:*** *The proper method of tightening wheel nuts is with a torque wrench, not with an impact wrench or by hand. Because of the importance of having proper torque on wheel nuts, you should have wheels mounted and properly torqued by authorized personnel with the proper tools.*

## **SPARE TIRE HOIST**

**NOTE:** This Hoist is designed for manual use with the driving tool only. An impact tool should never be used to drive a hoist, damage will result.

### **To lower spare tire:**

1. Remove travel nut on spare tire.
2. Locate access hole in rear bumper behind license plate of vehicle, or access the driving feature for hoist.
3. Insert driving tool into access hole until end of driver comes into contact with hoist drive feature. This may be a hex on the end of a drive extension tube, or an actuator feature on the end of hoist drive shaft.
4. Rotate drive tool and hoist drive shaft in a counter clockwise direction until the tire is lowered to the ground.
5. Take hold of wheel/tire and pull wheel/tire from under vehicle as far as possible.
6. Some looseness must be left in the cable so that the hoist lift plate (metal part of hoist assembly under wheel attached to hoist cable) can be disengaged from the wheel/tire assembly.

### **To attach hoist lift plate to the wheel/tire assembly:**

1. Place wheel/tire close enough to vehicle for hoist cable with lift plate attached to reach center of wheel/tire. (Wheel must be positioned so that the raised portion of the rim is up.)
2. Fold cable over on the lift plate if necessary and insert through the hole in wheel. Make sure lift plate is all the way through wheel.
3. Pull wheel/tire rearward, away from vehicle so that hoist cable is taunt/tight and lift plate has wheel opening resting on the steps of the lift plate.

### **To raise and stow the wheel/tire assembly:**

1. Insert driving tool into hole in rear of vehicle, or access to driving feature for hoist, and push in until engaged in the driving feature of hoist. This may be a hex on end of a drive extension tube, or an actuator feature on the end of the hoist drive shaft.
2. Rotate drive tool clockwise until wheel/tire assembly is pulled under vehicle, and is pulled up against bottom of vehicle.
3. Continue to rotate in the clockwise direction until at least two crisp breaks are felt, and or clicks are heard. This “stows” the wheel/tire, by forcing the hoist clutch through an “overload” condition.
4. This has now raised the wheel/tire up under the vehicle and “stowed” it with the proper force to hold the wheel/tire assembly in place during vehicle use. Always check wheel/tire assembly for looseness by pushing against or shaking from underneath. Hoist cannot be over tightened.
5. Replace travel nut on spare tire.

## **FLIP DOWN STYLE TIRE CARRIER**

### **WARNING**

**Do not lie under the carrier when retrieving the spare tire as the carrier will flip downward to remove the spare.**

To lower spare tire:

1. Locate the spare tire. It will be located under the frame just in front of the trailer hitch.
2. Using either a 9/16" or 3/4" wrench (depending on model), loosen the bolt/s that hold the spare tire carrier up. This will allow the rear of the carrier to pivot toward the ground. (Note: On some units it may be necessary to completely remove the nut/s in order to get the tire out.)
3. Once the carrier is lowered, slide/pull the spare tire off of the carrier.

**To raise spare tire:**

1. Slide the tire up and onto the tire carrier.
2. Using either a 9/16" or 3/4" wrench (depending on model), tighten the J-bolt nut/s on the tire carrier. Doing so will compress the tire in the carrier for a tight fit. (The tire needs to be compressed tightly, as failure to do so could result in the tire sliding off of the carrier.)
3. Get the flat tire repaired as soon as possible.

**NOTE:** *Replace the locking nut/s on the J-bolts with new ones of appropriate size and quality.*

## **WHEEL AND TIRE BALANCING**

Handling and tire wear can be enhanced by maintaining the proper balance of wheel and tire assemblies. It is important to have wheel and tire balancing checked on a regular basis. If you experience handling problems or abnormal tire wear, it may be easily corrected by proper balance. Specialized equipment is required to effect proper balancing, and the motorhome should be taken to a shop that is qualified to perform this service.

## **FRONT SUSPENSION AND ALIGNMENT**

Maintaining proper alignment will result in increased steering ease and stability of the motorhome. Because of this, tires and suspension will last longer and fuel economy will be increased. Many times, problems with tires can be traced back to poor maintenance which will cause mechanical failures in the motorhome. This is why it is important to follow a regular scheduled maintenance plan that can identify and correct mechanical problems before they cause greater and increasingly more expensive mechanical failures. Safety is also always enhanced by a properly maintained vehicle.

The term alignment refers to both the adjustment angles on the steering axle and suspension and the tracking of the rear axle. Many factors are considered when establishing proper alignment. Steering components, suspension, wheel bearings, and even proper loading all effect alignment.

Any time you notice unusual tire wear or experience poor handling of the motorhome, it would be wise to suspect improper alignment along with the various other possibilities that might be causing the problem (check the chassis owner's manual). Always have the alignment of the

motorhome checked and adjusted by a qualified shop with the proper equipment to handle heavy vehicles.

**NOTE:** *The front end alignment of your motorhome has been set by the motorhome chassis and body builder to the specification for front and rear GVW of your motorhome. However, since alignment is affected by not only how much weight you add to the motorhome in the way of cargo and how much water/LP, etc. that you carry and how you disperse the cargo, we advise you to have the motorhome alignment checked in the loaded condition (the way you would travel down the road). Not having the alignment set in the loaded condition could result in abnormal tire wear.*

## **POWER PLANT AND DRIVE TRAIN**

Full operating and service information may be obtained by consulting the engine and drive train operating and service manuals provided by the chassis manufacturer. For maximum engine efficiency and long service life, always follow recommendations, as outlined by the chassis manufacturer. Regular visual inspections can help detect minor adjustments and needed maintenance. All other components of chassis should be inspected regularly per schedules set by chassis manufacturer.

Procedures for normal fuel stop service functions such as checking engine oil, coolant level, and drive belt condition are covered in the chassis owner's manual. Make sure to follow all schedules and procedures for regular routine maintenance as outlined.

## **ENGINE ACCESS**

### **WARNING**

**If the engine cover is not seated correctly, exhaust gases may leak into the motorhome, creating a dangerous and potentially lethal situation.**

The motorhome engine can be accessed for service from inside the motorhome. The engine cover between the driver and passenger seats can be removed.

When reinstalling engine cover, make sure that it is seated correctly without obstruction from carpet, floor mats, etc.

## **ENGINE COOLING SYSTEM**

### **WARNING**

**Ethylene glycol is a petroleum derivative which can ignite if exposed to high temperature, such as occurs on an exhaust manifold. The possibility of ethylene glycol igniting is increased if it is not diluted with water. It is important to properly dilute antifreeze with the proper mixture of water. Make sure to discuss the coolant needs of your vehicle with your chassis engine service representative.**

The engine cooling system requires regular, periodic service to operate at maximum efficiency. The condition of the engine coolant, hoses, and clamps should be checked annually. Make sure to follow the cooling system recommendations as outlined in your chassis engine owner's manual. If you notice, or suspect cooling system problems, make sure it receives immediate

attention. Proper and safe operation of the chassis engine cooling system and other chassis functions depends on maintaining the vehicle per the instructions and schedules published by the chassis and engine manufacturers.

Most cooling system concerns are usually made apparent by an overheating symptom. Regular inspections to check the belt conditions and tension, damage to fan or fan shroud, and the condition of hoses and hose clamps should be a regular part of your motorhome maintenance program.

The mixture of the coolant used in the engine cooling system is a very important aspect of proper cooling system maintenance. A 50/50 solution (water/coolant) will protect the cooling system against outside temperatures down to -34 degrees F. Plain water in the cooling system could cause engine damage to the freezing or lack of corrosion protection. A 100% solution of antifreeze could cause engine overheating because of its low heat transfer property. Pure ethylene glycol coolant also freezes at only -8 degrees F. (Ethylene glycol is commonly used as an antifreeze in engine coolant.)

## **PROPER LOADING AND WEIGHT DISTRIBUTION**

Your recreation vehicle has been designed to carry loads within specified limits. Exceeding these limits will greatly affect the handling of the recreation vehicle. These limitations are defined in three ways:

1. **Gross Vehicle Weight Rating (GVWR)** — Maximum permissible weight of this motorhome. The GVWR is equal to or greater than the sum of the Unloaded Vehicle Weight plus the Net Carrying Capacity.
2. **Gross Axle Weight Rating (GAWR)** — Maximum load carried by an axle: sum of rating may be more than GVWR to allow for load variations.
3. **Gross Combined Weight Rating (GCWR)** — means the maximum allowable loaded weight of this motorhome with its towed trailer or towed vehicle.

Check weight ratings of your recreation vehicle on the serial number identification tag on the recreation vehicle.

### **Additional terms used when discussing weight and distribution include:**

1. **Gross Vehicle Weight (GVW)** — The total loaded weight of the recreation vehicle.
2. **Gross Axle Weight (GAW)** — The total loaded axle weight under any given load condition.
3. **Unloaded Vehicle Weight (UVW)** — Weight of this motorhome as built at the factory with full fuel, engine oil, and coolants. The UVW does not include cargo, fresh water, LP gas, occupants, or dealer installed accessories.
4. **Net Carrying Capacity (NCC)** — Maximum weight of all occupants including the driver, personal belongings, food, fresh water, LP gas, tools, tongue weight of towed vehicle, dealer installed accessories, etc., that can be carried by this motorhome. (NCC is equal to or less than GVWR minus UVW).

**NOTE:** When establishing the cargo capacity, weigh your motorhome with all water tanks as empty as possible. Do not allow anyone to be in the recreation vehicle when establishing this rating.

DO NOT assume that you can fill all tanks and all storage areas and be within the GVWR. Weights of stored items and passengers will vary greatly and will affect total weight of your recreation vehicle.

Fresh water weighs 8.33 pounds per gallon. L.P. Gas weighs 4.5 pounds per gallon.

Always give careful consideration when loading your recreation vehicle so that items will be evenly distributed. Not only will the recreation vehicle handle and ride better, but you will have reduced tire wear and increased fuel economy. This will ensure that you have not overloaded one side or the other, affecting recreation vehicle handling. DO NOT store heavy items near the front or rear ends of the recreation vehicle.

It is recommended to empty the holding tanks before leaving on a trip, and as often as possible when traveling, to help keep weight reduced. Try to carry only as much fresh water as you will use when traveling. Sometimes, the water tanks can be used to balance the weight in the recreation vehicle.

It is also important to keep in mind when traveling, that all items stored inside and outside the recreation vehicle are secure, and all doors and drawers are secure. DO NOT add any type of rack or frame to any recreation vehicle frame or chassis part. The alteration to length and/or weight distribution may result in unstable handling, be a safety hazard, or could damage the recreation vehicle components. In any case, the recreation vehicle warranty may be affected.

## **COMPUTING YOUR LOAD AND LOAD DISTRIBUTION — (Motorized RVs)**

In order to properly compute your load and load distribution, you must know both actual scale weights, and the GAWR and GVWR found on the Federal Certification Label on the motorhome. Weigh with all passengers, equipment, luggage, and fluids on board as you plan to travel with.

**To weigh your motorhome properly, use the following procedure:**



1. Front Axle Weight



2. Total Vehicle Weight



3. Rear Axle Weight

1. All passengers must be in their seats and the **vehicle level**. Place the front axle only on the scale. Check the weight against the front gross axle weight rating.
2. Pull forward so that both axles are on the scale. Check the weight against the gross vehicle weight rating.
3. Pull forward again so that only the rear axle is on the scale. Check the weight against the rear gross axle weight rating.

**NOTE:** The vehicle must be setting on level ground when weighing the front or rear axle separately. The weight distribution will be greatly affected if this is not done and the weights will be inaccurate.

**Compare scale weights with capacities as shown in the following example:**

There are various weight ratings depending on the model and chassis manufacturer. This example uses weight ratings based on a hypothetical chassis. Other models are figured in the same way with their appropriate weight ratings. Remember, these examples are assuming a fully loaded coach; passengers, equipment, luggage, and fluids, just as you will be traveling with. *This example is hypothetical only. Your weights will vary. It is the procedure for establishing reserve capacity and weight balance that we are showing here.*

If at this point, any overload or imbalance occurs, the load will have to be distributed to compensate, and weighed again.

Once you become familiar with loading your motorhome, and know how to distribute the weight and which items you normally carry, make a list and diagram you can use for future reference. Plan your loading and storage so that emergency items are easily accessed.

Keep in mind that if you make any major changes in the items you take along, or you install additional equipment, that it will be necessary to re-weigh your motorhome. **DO NOT ASSUME THAT YOU CAN TOW ADDITIONAL VEHICLES BEHIND YOUR MOTORIZED RECREATION VEHICLE,** as it may substantially affect your performance and structure of your vehicle.

Hypothetical example	
GVWR	14,500 lb.
GVW	12,570 lb. From scale
Carrying Capacity	1,930 lb.
Front GAWR	5,000 lb.
Front GAW	4,000 lb. From scale
Front Axle Carrying Capacity	1,000 lb.
Rear GAWR	10,000 lb.
Rear GAW	8,890 lb. From scale
Rear Axle Carrying Capacity	1,110 lb.



## WEIGHT INFORMATION LABEL

# CAUTION

### Do not overload your motorhome.

A WEIGHT INFORMATION LABEL, similar to the following diagram, has been placed inside a wardrobe in your motorhome. These weights are based on calculations involving similar vehicles as yours and will not be the exact weight of your vehicle. You will need to weigh your vehicle to determine the exact weights and carrying capacities of your vehicle.



701 CR 15  
PO Box 1486  
Elkhart IN 46516-0731

**MOTORHOME WEIGHT SPECIFICATIONS**  
**SPÉCIFICATIONS DE POIDS CONCERNANT LES MOTOR-HOMES**

<b>PRODUCT:</b> <small>Produit:</small>	<b>SERIAL #:</b> <small>N° de série</small>	
<b>MODEL:</b> <small>Modèle:</small>	<b>YEAR:</b> <small>Année:</small>	<b>CHASSIS VIN #:</b> <small>N° d'identification du véhicule sur le châssis</small>

---

<b>Gross Axle Weight Rating - GAWR</b>	<b>LBS - livres    KG / kilos</b>
<small>Maximum permissible load carried by an axle - (sum of rating may exceed GVWR). Estimation du poids brut de l'essieu</small>	<b>Front:</b>
<small>Poids maximum permis pouvant être supporté par un essieu (le total de l'estimation peut excéder l'estimation du poids brut du véhicule).</small>	<b>Avant:</b>
	<b>Rear:</b>
	<b>Arrière:</b>

---

<b>Gross Vehicle Weight Rating - GVWR</b>	
<small>Maximum permissible weight of this fully loaded motorhome. Estimation du poids brut du véhicule</small>	
<small>Poids maximum permis de cet motor-home chargé à fond.</small>	

---

<b>Gross Combined Weight Rating - GCWR</b>	
<small>Maximum allowable load weight of this motorhome and any towed trailer or towed vehicle. Estimation du poids brut combiné</small>	
<small>Poids maximum de charge alloué pour cette motorhome et toute remorque ou voiture remorquée.</small>	

---

<b>Unloaded Vehicle Weight - UVW</b>	
<small>Weight of this motorhome as manufactured at the factory with full fuel, engine oil and coolants. Poids du véhicule sans charge</small>	
<small>Poids de cet motor-home tel que fabriqué à l'usine avec un plein d'essence, d'huile de moteur et des fluides de refroidissements.</small>	

---

<b>Sleeping Capacity Weight Rating - SCWR</b>	
<small>Motorhome manufacturer's designated number of sleeping positions multiplied by 154 pounds (70 kilograms) Estimation du poids de capacité de couchage</small>	
<small>Le nombre de position de couchage tel qu'indiqué par le fabricant du motor-home multiplié par 154 livres (70 kilogrammes).</small>	

---

<b>Cargo Carrying Capacity - CCC</b>	
<small>Equal to GVWR minus each of the following: UVW, Full fresh (potable) water (including water heater), full L.P. gas weight and SCWR. (Note: dealer installed equipment and towed vehicle tongue weight will reduce CCC)</small>	
<b>Capacité de transportation de cargo</b>	
<small>Égal à l'estimation du poids brut du véhicule moins chacun des suivants: le poids du véhicule sans charge, le poids du plein d'eau potable (incluant chauffe-eau), le poids du plein d'essence et l'estimation du poids de capacité de couchage. (Note: les équipements installés par le concessionnaire et le poids du véhicule remorqué sur la boule de remorque vont réduire la capacité de transportation de cargo.)</small>	

Fresh water w/ water heater @ 8.33 lbs./gal.	Gals.
Eau potable avec chauffe-eau @ 1 kg/litre	litres
LPG capacity @ 4.2 lbs./gal	Gals.
Capacité d'essence @ 0.54 kg/litre	litres

---

**WARNING:** This information is intended as a guide only. Weights of individual vehicles may vary. Consult Owners Manual(s) for specific weighing instructions and towing guidelines including auxiliary brake requirements for any towed trailer or towed vehicle.  
**Caution:** Consulter le manuel du propriétaire pour les instructions spécifiques de pesage et les directions de remorquage incluant les exigences de freins auxiliaires pour toute remorque ou voiture remorquée.



## **DRIVING**

Now that you have determined your vehicle's weight and balance you are ready to pull out onto the open road.

Once you get acquainted with your vehicle, you should find that it drives and handles much like a large passenger car with a few notable exceptions that include: length, height, width and weight.

The vehicle is equipped with more than adequate brakes, however, its stopping distance may be much greater than your automobile. Get accustomed to it. Keep it in mind at all times and be alert to changing road conditions.

It would be helpful to take your new RV out to a stadium parking lot and spend some time getting the feel of the wider and longer vehicle.

Small fluorescent sports cones, available at sporting goods and toy stores, can be used to create turns and parking spaces. Dowels with small flags can be attached to make the cones more visible in the passenger's side view mirror. Practice parallel parking, backing and turns.

Afterwards, the cones can become an addition to your safety equipment.

Get your spouse to work with you, having them help guide you from both the passenger seat and from a position outside using hand signals.

The other vehicle characteristic that needs to be taken into consideration immediately is height. Read all "clearance" signs when approaching parking garages, drive-through windows and even underpasses on older highways. Also be careful of overhanging trees. Always use caution and when in doubt get out and look.

Don't forget any added equipment that may protrude higher than the standard factory height.

Passing and pulling out into traffic in your RV is going to be different than when driving your everyday vehicle. Generally speaking, it will take more time, thus, more distance to pass when it necessitates driving in an oncoming lane of traffic.

It will take more time to clear an intersection from a dead stop. Allow more distance between cars.

Because your RV is longer and wider than your other vehicles, a bit more attention must be paid to cornering. Practicing in a stadium lot is helpful, as indicated earlier.

The main idea is to pull several feet past the apex of the corner before initiating the turn. This is to give extra room for the rear inside wheels to clear the inside curb. Instead of cutting corners, learn to use the entire roadway by bringing the vehicle closer to the center stripe of the street or road you are entering. However, do not swing "out" or over the centerline of the road you are turning off.

Because of the extra room your vehicle needs to clear the inside curb, you must be fully aware of the traffic that you are turning into (what becomes the oncoming traffic after the turn). Note how close the vehicles are to the center line and especially if they are over the center line and into your lane.

## **HILLS, DALES AND MAKING THE GRADE**

Your RV adventures are going to take you to new and exciting areas of the country, including those areas with breathtaking views. In other words: hill country.

Driving in hilly or mountainous terrain isn't any more difficult than driving on the flat plains of Kansas if the driver uses the vehicle properly.

The main culprit of hilly or mountainous driving problems is overheating. And it's not just the cooling system that suffers this malady.

Preventing problems is as simple as following your chassis manufacturer's driving instructions for this type of terrain. The main thing to remember is to reduce speed and drive in the appropriate gear, usually something other than Drive.

On downgrades a lower gear helps to assist in braking, thus preventing overheating of the brakes and the possibility of poor brake performance.

The modern RV, unlike its forerunners, is equipped with front disc brakes that are more powerful and more fade resistant than the old drum and shoe combinations of the past. However, if abused, they can deliver less than satisfactory performance.

Upgrades are handled in the same manner: a lower gear and speed.

## **TRAILER TOWING**



### **WARNING**

**A separate functioning brake system is required for any towed vehicle or trailer weighing more than 1000 lbs. (450 kg.) when fully loaded. Failure to heed any part of this warning could result in loss of control of the motorhome and towed vehicle or trailer and may cause accident and serious injury. For specific towed vehicle braking requirements, consult the chassis owner's manual that comes with this vehicle.**

### **CAUTION**

**Do not exceed the vehicle's Gross Combined Weight Rating (GCWR) or the hitch rating. Towing Capacity may be less than Hitch Capacity. Consult with your selling dealer to determine the GCWR of your vehicle. Do not assume that you can tow a vehicle which happens to be within the capacity of the hitch. It may exceed the total GCWR of the motorhome.**

**Always use safety chains between the motorhome and the towed trailer or vehicle. Cross chains under the trailer tongue and allow slack for turning corners. Connect safety chains to the vehicle frame or hook retainers. Never attach chains to the bumper of a vehicle.**

**Tow bars or car dollies generally are made to travel in a forward direction only. Most towing equipment of this type is not designed for backing. Never attempt short back up distances with a tow bar or tow dolly. Damage to the motorhome, vehicle or towing device will result.**

***NOTE: Four Winds International accepts no responsibility for damage to the chassis and other components resulting from towing loads greater than its designated class specifications. You will***

*also need to consider the gross combined weight rating of your motorhome before towing a trailer or car.*

Trailer packages that include high quality tow hitches are available as an option on Four Winds International RVs. They are designed to meet class specifications for your particular vehicle.

Towing an object such as a boat and trailer or car behind an RV results in added driving considerations.

When purchasing a new or borrowing an unfamiliar trailer it would be best to take a drive around the area of your home prior to setting out on a longer trip.

Include a stint at highway speeds to confirm the trailering characteristics of your RV and the particular trailer you are using.

Weight distribution of the trailer cargo has a great influence on handling qualities. For instance, a fishing boat with a small engine tows well; however, buy a new, larger, heavier outboard motor for the boat and trailering becomes a nightmare.

Towing capacity may vary by motorhome make and model. We recommend you weigh your motorhome and trailer or towed vehicle fully loaded. The motorhome fully loaded and the trailer, or towed vehicle, must not exceed the motorhome chassis' Gross Combination Weight Rating (GCWR). Do not exceed the vehicle's Gross Combined Weight Rating (GCWR) or the hitch rating. The tongue weight, the weight pushing down on the hitch, must not exceed 10% of the hitch capacity. A separate functioning brake system is required for any towed vehicle or trailer weighing more than 1000 lbs (450 KG) when fully loaded.

## **EMERGENCY STOPPING AND TOWING**

**If an emergency ever requires you to be stopped, be sure to follow these guidelines:**

1. Pull off the road as far as possible.
2. Turn on your hazard warning flashers.
3. If traveling at night, use three red warning indicators such as flares, reflectors, or lanterns as required by the Uniform Vehicle Code and Model Traffic Ordinance as follows:
  - a. Place the first at traffic side of the vehicle, directed at the nearest approaching traffic.
  - b. Place the second 100 feet behind the recreation vehicle in the center of the lane and toward approaching traffic.
  - c. Place the third 100 feet in front of the recreation vehicle in the center of the lane and away from the traffic approaching from behind.
4. Always stand off the road.

***NOTE:*** *Curves and/or hills may affect the safe placement of warning indicators.*

## **TOWING PROCEDURES**

### **WARNING**

Due to multiple variables that exist in towing, operating/positioning the lifting and towing device is the sole responsibility of the tow vehicle operator. The operator must be familiar with standard towing industry safety measures. Improper procedures could result in severe personal injury or death.

### **CAUTION**

Never tow the motorhome at a speed greater than 50 mph. Never allow anyone to ride in the motorhome while it is being towed. Make sure to review the chassis owner's manual for any additional requirements or cautions concerning the towing of the motorhome.

### **CAUTION**

In case the motorhome requires towing, ensure all precautions are followed. The drive shaft must be disconnected and the mud flaps may need removed. The manufacturer **WILL NOT** cover damage to the motorhome caused by a towing company.

When attempting to tow a vehicle with air suspension, ensure that the air suspension system is properly aired. Attempting to tow a vehicle with an improperly aired suspension may result in damage to the chassis and body.

If the motorhome needs to be towed:

- Never allow anyone to go under a motorhome while it is being lifted by towing equipment unless the disabled motorhome is adequately supported by safety stands.
- The mud flaps may need to be removed to prevent damage due to limited ground clearance.
- It may be necessary for the tow vehicle operator to disengage the brakes prior to towing. Refer to your vehicles chassis owner's manual for any procedures necessary.

## **FUEL PUMP COLLISION SHUTOFF SWITCH (Ford)**

### **WARNING**

If you see or smell gasoline at any time other than during fueling, do not reset the switch. Make sure that there is no damage to fuel related components before resetting the inertia switch.

If your motorhome is involved in a collision, it is possible that an inertia switch in the fuel pump circuit will open, shutting down the flow of fuel to the engine. This is a safety feature designed to help keep raw fuel from spilling out and creating additional danger. When this inertia switch has been tripped, it is necessary to manually reset it before the motorhome can be restarted and moved. Review your chassis owner's manual for the location of the switch and instructions for resetting.

## **FUEL RECOMMENDATIONS**

Pay close attention to the fuel recommendations outlined in your chassis literature. Also, remember that the motorhome generator may be fueled by the same system as is used to fuel the motorhome chassis engine, and you should consider the gasoline requirements of the generator when making a decision on the type of fuel to use. Check both the chassis and generator owner's manuals to help you establish the type of fuel best suited for this dual application.

**NOTE:** *Using fuel with the proper octane rating can add to your driving economy. Make sure to check the chassis owner's manual for recommended octane levels for your motorhome.*

## **FUEL FILLING**



**DANGER**

**Be extremely careful when fueling your motorhome. Always shut off the engine, do not smoke, or use cellular phone and shut off all pilot lights before adding fuel. Fuel spills represent a serious fire hazard, and should be cleaned up immediately. Never restart the engine, or relight pilot lights while raw fuel is present.**

Always remove the fuel cap slowly, allowing pressure built up in the fuel tank to escape gradually before removing the cap. If you spill fuel on the motorhome, clean it up immediately, since fuel can dull or soften paint and damage other surfaces. If you should lose your fuel cap, it should be replaced as soon as possible, with a cap of the same type.



# DASH CONTROLS & INSTRUMENT PANEL

## ***DASH CONTROLS (Class C Mini-Motorhomes)***

The controls in your mini motorhome are all chassis factory installed. Refer to your chassis owner's manual for complete instructions.

## ***DASH CONTROLS (Class A Motorhomes)***

You should thoroughly familiarize yourself with the various controls, instruments, and indicators available to you in your motorhome. Performance and safety can be enhanced by the driver who fully understands each one, and how to use them.

**IMPORTANT:** The chassis owner's manual furnished with your motorhome has complete information for operating and maintaining chassis functions. Make sure to read and follow all instructions in the chassis owner's manual, paying particular attention to all precautions and warnings associated with its use.

## **TYPICAL CHASSIS INSTRUMENT PANEL (Class A Motorhomes)**

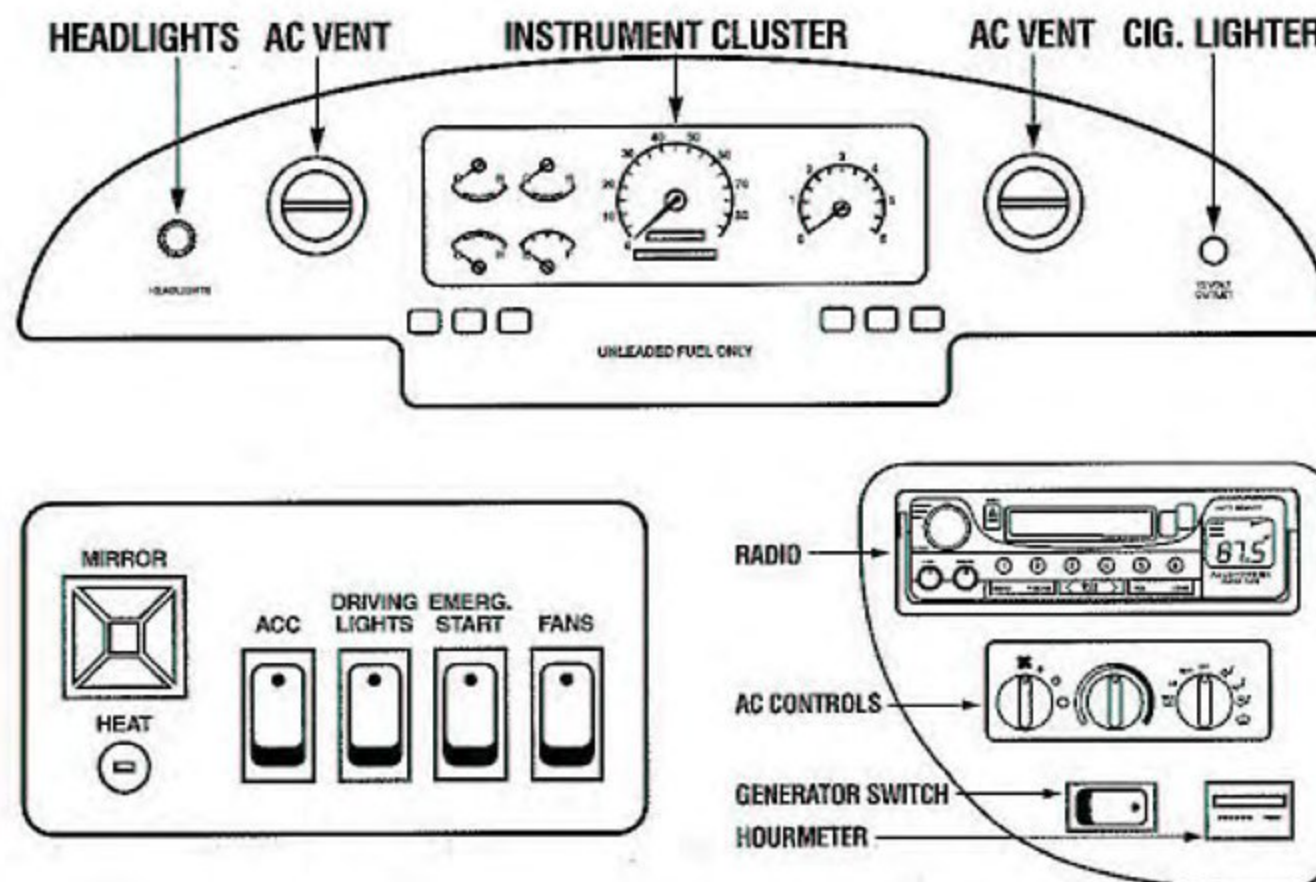

## ***CHASSIS INSTRUMENT PANEL***

Use of gauges, controls, and indicator lights are covered in your chassis owner's manual. Be sure to read all instructions in the chassis owner's manual. Always pay attention to and follow the precautions, warnings, and maintenance instructions outlined there.

If the appearance or placement of the gauges, instruments, and controls does not exactly match the illustration in your chassis owner's manual, the instructions for their use will still apply.

Steering column controls and functions are also covered in the chassis owner's manual.



## **HEADLIGHT SWITCHES**

The three position headlight switch controls the instrument, parking, marker, tail and headlights as illustrated. Rotating the Rheostat switch controls the brightness of the instrument lights.

## **WIPERS**

Left and right hand wipers are activated by a single control. This control has an intermittent wiper feature. Windshield washers for both sides are activated by pressing on the center of the wiper control. Some motorhomes may have the wiper controls as part of the turn signal lever.

**NOTE:** *You should check the level of the washer fluid regularly. Use a washer fluid that is intended for this purpose to clean better and offer protection from freezing. DO NOT use additives such as radiator antifreeze in the washer fluid that might cause damage to either the washer system or the motorhome finish.*

**NOTE:** *To prevent possible damage to your windshield or wiper blades, do not operate the wipers when the windshield is dry.*

## **GENERATOR REMOTE SWITCH AND HOUR METER**

Controls the remote ON/OFF operation of the generator. Make sure to read all information on generator operation elsewhere in the owner's manual.

## **CIGARETTE LIGHTER**

To use the lighter, press in all the way and let go. It will pop out by itself when it is ready.

**NOTE:** *Do not hold a cigarette lighter in with your hand while it is heating. If you do, it won't be able to back away from the heating element when it's ready. That can make it overheat, damaging the lighter and the heating element.*

## **HEATED MIRROR SWITCH**

This switch activates heaters in each of the outside mirrors that defrost them when required. Turn the heaters off when the mirrors are defrosted.

## **POWER MIRROR ADJUSTMENT**

The power mirror functions for both left and right hand mirrors are controlled by this single switch. A center switch is used to select either the left (L) or right (R) hand mirrors. The outer control is used to control the movement of the mirror selected. Pressing on one of the four sides moves the selected mirror in the direction indicated by the arrow on that side.

Always adjust mirrors for proper vision before starting and moving the motorhome. Each side is equipped with both normal and wide angle mirrors for more complete vision.

## **DASH HEATER/AIR CONDITIONER**

Your new motorhome has been equipped with the industry's highest performance integrated heating/air conditioning system. While this system is much more powerful than those used in passenger cars, it is, nonetheless, not capable of heating and cooling the entire motorhome. This system is designed to provide windshield defrost and heating and cooling for the front seat occupants only. By following the operating instructions and tips, this heater/air conditioner will provide many years of comfort and dependable service.

### **SYSTEM LAYOUT**

The heater/air conditioner unit is located beneath the dash on the passenger side of the vehicle with heating and cooling coils located on the outside of the firewall. In most modes of operation the unit takes fresh air from outside, and heats or cools it before discharging into the vehicle. Only when operated in the MAX A/C mode does the system take air from inside the vehicle.

The type and location of the air discharge outlets can be different in each model motorhome. Consult your dealer on the location and operation of the air outlets on your motorhome. Proper adjustment of air outlets will provide maximum comfort.

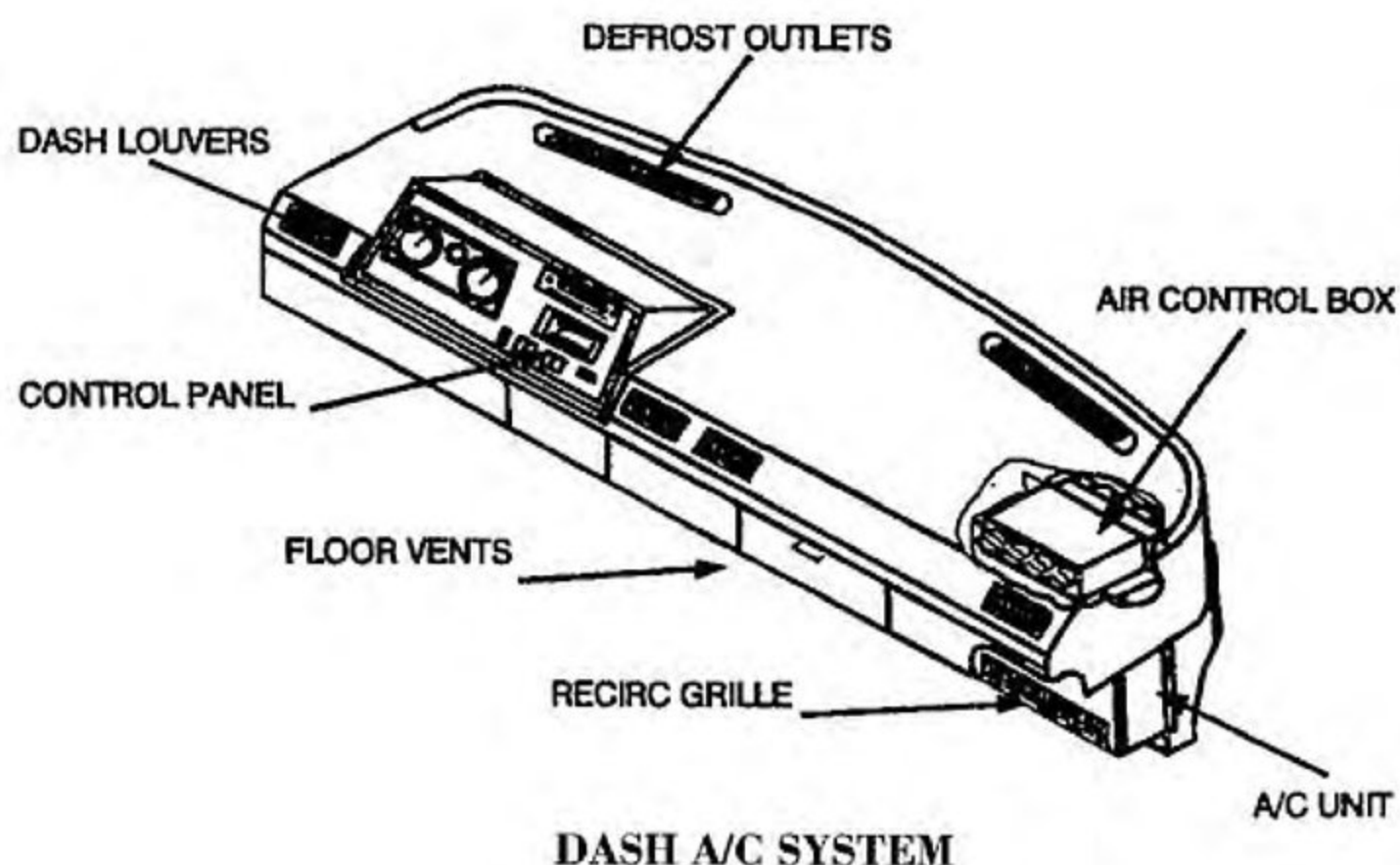

### **OPERATING INSTRUCTIONS**

#### **CONTROL PANEL OPERATION**

The control panel enables the driver to control the temperature, volume and direction of the air discharged from the heating/air conditioning system.

#### **BLOWER CONTROL**

One of the best ways of controlling temperature is by changing the speed of the blower. The blower knob (left of center) provides 4 speeds in any mode except OFF.

#### **TEMPERATURE CONTROL**

The center knob controls the temperature of the discharge air. Turn the knob to the right (red area) for warmer air, and to the left (blue area) for cooler air.

## OPERATING FEATURES

The air conditioning system is designed to operate in all modes except VENT, FLOOR, and OFF. This provides significant moisture, dust and pollen removal for enhanced passenger comfort.

The A/C will not function if the outside air temperature is below approximately 40 degrees F.

In the event control vacuum is lost, the system is designed to discharge through the defrost vents.

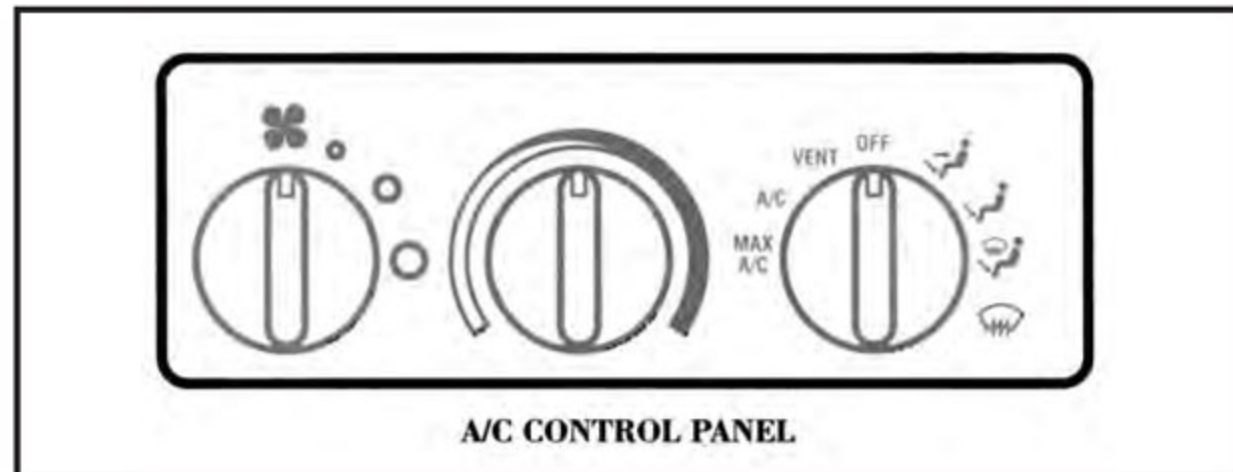

## AIR DISTRIBUTION - MODE CONTROL

To achieve the maximum comfort in your motorhome, the air must be directed where it is needed. The mode switch (right of center) gives the driver the ability to select where the air will flow.

**MAX A/C** Air is drawn from the passenger compartment (Recirculated Air) and discharged through the dash louvers. These louvers can be adjusted for maximum comfort.

**A/C** Outside air (Fresh Air) is drawn into the system and discharged through the dash louvers. These louvers can be adjusted for maximum comfort.

**VENT** Outside air is drawn into the system and discharged through the dash louvers. For enhanced passenger comfort, upper-level ventilation air is also discharged through the defrost opening.

**OFF** The blower motor does not operate in this mode. The fresh air inlet door closes, minimizing outside air infiltration into the vehicle.



Outside air is drawn into the system and discharged through the dash louvers, floor and defrost outlets. The A/C system operates in BI-LEVEL mode.



Outside air is drawn into the system and discharged through the floor outlets. In some models a small amount of air is directed to the windshield for defrost. The A/C system does not operate in FLOOR mode.



Outside air is drawn into the system and discharged through the floor and defrost outlets. The A/C system operates in MIX mode to provide windshield defogging.



Outside air is drawn into the system and discharged through the defrost outlets. The A/C system operates in DEFROST mode to provide windshield defogging.

## IMPORTANT OPERATING TIPS

### WINTER OPERATION

The discharge air will heat up faster if the blower is operated on lower speeds until the engine is hot.

For windshield de-icing use **DEFROST** mode.

### SUMMER OPERATION

#### MAXIMUM COOLING

- Use MAX A/C and **HI** blower for quick cool down.
- A lower blower speed produces cooler air.
- Close all windows and vents to hot, humid outside air.
- Close curtains which do not obstruct the driver's vision.

### CARE AND SERVICE

- Keep the condenser and radiator free of bugs and debris.
- During periods of little use, operate the A/C system monthly to keep the compressor lubricated.
- Periodically inspect belts and hoses for wear and proper tension.

## **WARNING**

**The air conditioning system contains refrigerant 134a under high pressure and should be serviced by qualified personnel only. *Improper service methods could cause serious personal injury.***

### WARRANTY/SERVICE

If repairs are required during the warranty period, contact your dealer.

If traveling, contact Four Winds International.

**NOTE:** *Unauthorized repairs may void the warranty.*

## CD PLAYER

Your motorhome includes a CD player with AM-FM radio. Consult the owner's manual for complete operation instructions.

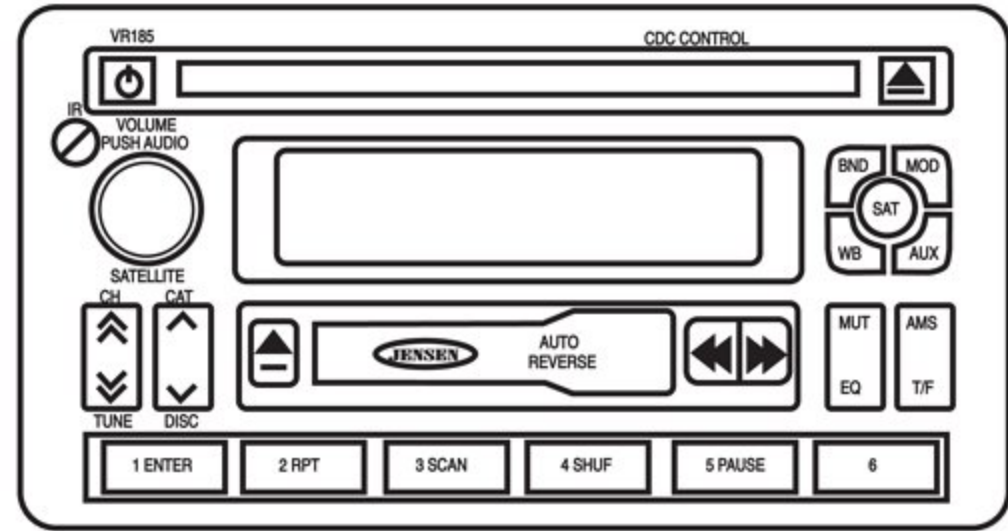

## DASH SWITCH PANEL

### FAN



## CAUTION

**Do not remove the protective cage from the fan. Do not allow anyone to place fingers or other objects into the protective cages.**

The fan switch turns the power on or off to the overhead defroster fans. Each fan can be operated separately with individual switches on each fan if this switch is in the ON position.

### DRIVING LIGHTS

The driving lights switch controls the on/off operation of the driving lights.

### ACCESSORY

This switch is placed in the dash as a convenience for the owner who wishes to install additional 12 volt functions to the vehicle. It is wired to the fuse block on the front firewall under the hood.

### EMERGENCY START

Holding this switch down while turning the ignition switch will allow the auxiliary "house" battery(s) to be used to start the engine in the event the automotive battery is low or dead.

This feature is designed to be used momentarily to start the engine. **DO NOT** hold the switch down for extended periods of time. Overheating will occur causing serious electrical failure and damage to electrical components.

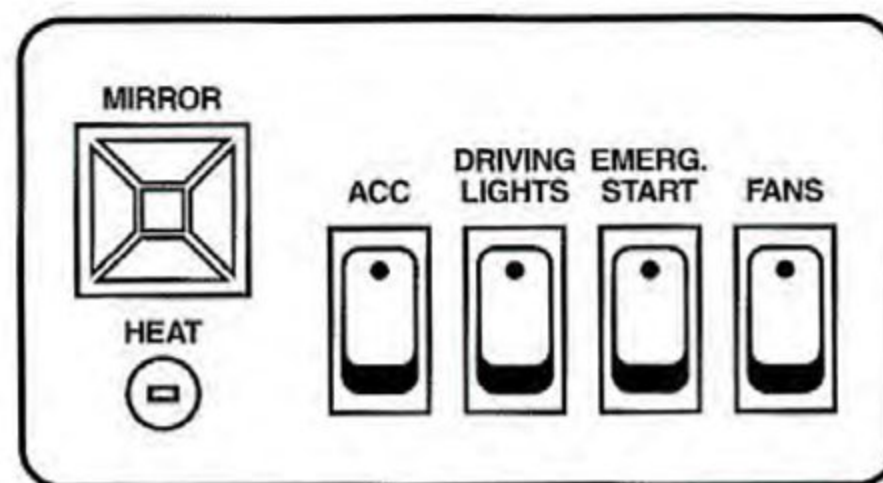

## ***HYDRAULIC POWER LEVELERS (EQUALIZER SYSTEMS)***

### **WARNING**

**Read the entire operators manual before operating.**

**Do not attempt to operate the system while the motorhome is in motion.**

**Block frame and tires securely before crawling under vehicle. Do not use leveling jacks or air suspension to support vehicle while under vehicle or changing tires. Vehicle may drop and/or move forward or backward without warning causing injury or death.**

**Keep all people and equipment clear of vehicle while leveling system is in use.**

**Never place hands or other parts of the body near hydraulic leaks. Oil may penetrate skin causing injury or death.**

**Wear safety glasses when inspecting or servicing the system to protect eyes from dirt, metal chips, or leaks, etc. follow all other applicable shop safety practices.**

**Do not over extend the rear jacks. If the weight of the vehicle is removed from one or both rear wheels, the vehicle may roll forward or backward, off the jacks.**

**Keep store levers in the store/travel position when jacks are not in use.**

**Make sure all slideout rooms are in the stored and locked position before leveling.**

### **CAUTION**

**Do not place the motorhome body in a twist while raising or lowering the motorhome. This could cause the windshields to crack or to become loose from the rubber gasket they are mounted in. Do not raise or lower one corner at a time. A complete side, front or rear end should be raised or lowered together to prevent the body from twisting.**

**The motorhome should be parked on a fairly level surface. Ensure that there are no obstructions in the extend or retract paths of the jacks. If the surface is soft due to saturation or heat, place boards under the jacks to distribute the weight over a larger area. Using a board which measures approximately 2' wide by 2' in length is recommended. Ensure the front tires are pointing forward and not to the left or right.**

The automatic hydraulic power leveling system allows quick and easy leveling of the motorhome from the driver's seat by utilizing the system touch panel. The following instructions are general operating instructions.

## AUTO LEVELING & RETRACTION PROCEDURES

### CAUTION

Do not manually overextend *individual* jacks singularly. This may cause unwanted stress on the coach or the jacklegs.

- 1. TURN ON POWER.** The power to the unit must be turned on before any function can be attempted. You need to have the ignition key in the OFF position and the parking brake must be set to turn the control panel on. Push the POWER touch pad to engage power. The power touch pad should be lit when power is on.
- 2. AUTO-LEVEL THE COACH.** Press the AUTO-LEVEL touch pad. The system will automatically level your vehicle. The control panel will send out a series of beeps to let you know that AUTO-LEVEL is operating. When completed, the panel will signal a successful AutoLevel. After ten minutes, the panel will enter sleep mode.
- 3. RETRACTING THE JACKS.** Your Equalizer System provides you with the ability to retract the jacks using the ALL RETRACT feature or the UP touch pads for each jack. Press and release ALL RETRACT touch pad. All jacks will automatically retract. The jacks are retracted when all of the LED'S have gone out. Depending on the vehicle, full retraction may take up to 90 seconds.

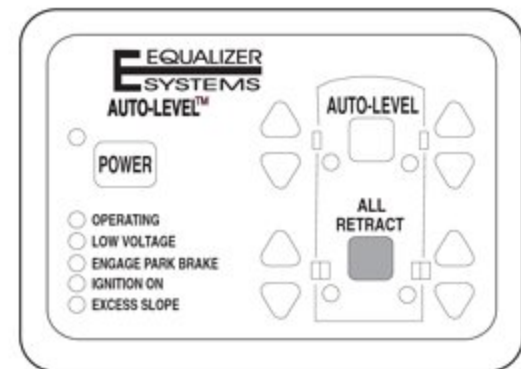
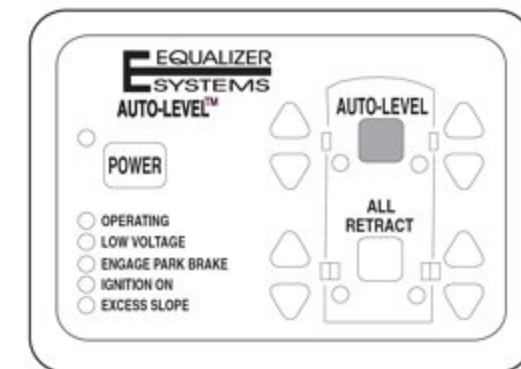
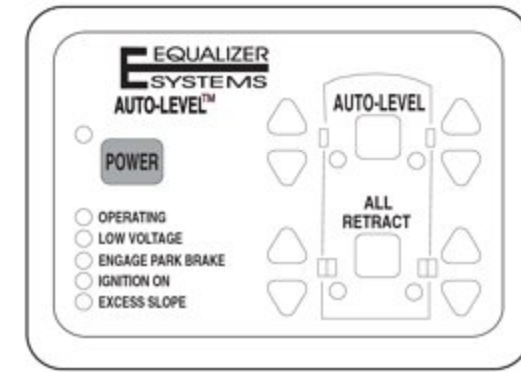

**NOTE:** The null, or level position has been preset at the factory. However, if you want to change the setting, or if the motorhome has been dormant for more than 60 days you may need to reset the null. Refer to the automatic hydraulic levelers owner's manual for detailed information regarding the proper procedures to do this.

## MANUAL LEVELING AND RETRACTION PROCEDURES

### WARNING

Do not manually overextend *individual* jacks singularly. This may cause unwanted stress on the coach or the jacklegs.

Do not attempt to lift the vehicle tires off of the ground. Do not over extend the rear jacks. If the weight of the motorhome is removed from the rear wheels, the motorhome may roll off the jacks.

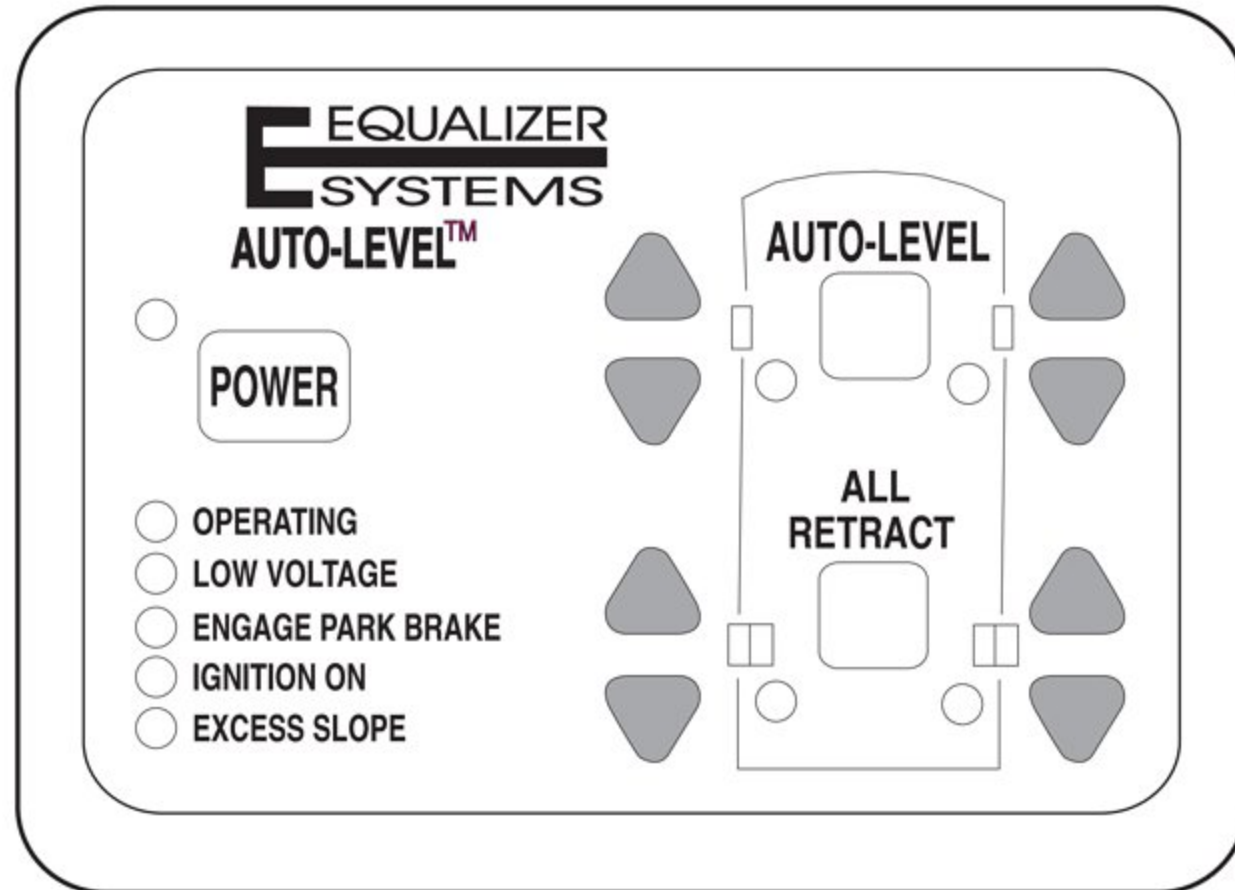

1. **TURN ON POWER.** The power to the unit must be turned on before any function can be attempted. You need to have the ignition key in the OFF position and the parking brake must be set to turn the control panel on. Push the POWER touch pad to engage power. The power touch pad should be lit when power is on.
2. **MANUAL LEVEL COACH.** Using the down arrow touch pad, extend each jack, an LED light positioned on the panel will illuminate indicating the jack to be out of the stowed position.

**NOTE:** Jacks may be operated individually or in pairs as long as they are operated in the same direction.

3. Use a bubble level on a flat surface in the center of the coach as a reference. Level the vehicle by using the DOWN ▽ or UP △ touch pad buttons until the vehicle is level. Jacks may be operated individually or in pairs as long as they are operated in the same direction. Do not attempt to lift the vehicle off of the tires. The panel may be turned off once level has been achieved.
4. **MANUAL LEVEL RETRACTION.** The Equalizer System provides the ability to retract the jacks using the ALL RETRACT touch pad button or the UP △ touch pad for each individual jack. All jacks will automatically retract and return to stowed position when the ALL RETRACT touch pad is pressed and released. The pump will run in retract mode for 60 seconds to ensure the jacks are fully stowed.



## **EMERGENCY RETRACTION PROCEDURE**

### **WARNING**

Following manual override operation, failure to return all valves to normal position may result in one or more jack legs drifting down from their retracted (stowed) position. For cartridge valves, rotate the center screw fully counter-clockwise. For directional valves, rotate the red knob until it 'snaps' back to the normal position.

In the event of electrical failure, the jack leg(s) may be retracted manually by following the procedure below.

1. The individual cartridge valves are clustered together on the side of the pump manifold. (They are labeled 1 thru 4 on the diagram on the next page). Locate the screws on the appropriate cartridge valve(s). Using a small flat blade screwdriver, turn the screw(s) clockwise until all the way in\*.

*\* **Note:** The normal operating position of the screw in the cartridge valve is the counter-clockwise 'out' position. The only time the valve should be shifted manually is when attempting to operate jack(s) via manual override.*

2. Locate the red knurled knob on the directional valve\*\* DV2. This valve will be on the opposite side of the manifold from the cluster of cartridge valves. Pull the red knob out and turn 1/4 turn. The knob will remain in the 'out' position.

*\*\* **Note:** The normal operating position of the red knob on the directional valve(s) is the 'in' position. The only time the valve should be shifted manually is when attempting to operate jack(s) via manual override.*

3. To retract, locate the red knurled knob on the directional valve\*\*DV1. This valve will be on the adjacent side of the manifold to the cluster of cartridge valves. Pull the red knob out and turn 1/4 turn. The knob will remain in the 'out' position.
4. Remove the black plastic cap from the top of the motor. Use a small flat head screwdriver. Place the drill with the 7/16" (11mm) hex bit on the manual override shaft located at the top of the motor. Run drill in a clockwise direction at 2000 r.p.m. (minimum). The jack leg(s) will retract.
5. When retraction is complete, return the cartridge valve(s) and the directional valves DV1 & DV2 to the normal positions. Reinstall black plastic cap on the motor.

#### ***HOSE COLOR IDENTIFICATION***

<b>LOCATION</b>	<b>EXTEND</b>	<b>RETRACT</b>
JACK # 1 (DRIVER FRONT)	GREEN	GREEN / BLACK
JACK # 2 (DRIVER REAR)	PURPLE	PURPLE / BLACK
JACK # 3 (PASSENGER REAR)	GRAY	GRAY / BLACK
JACK # 4 (PASSENGER FRONT)	RED	RED / BLACK

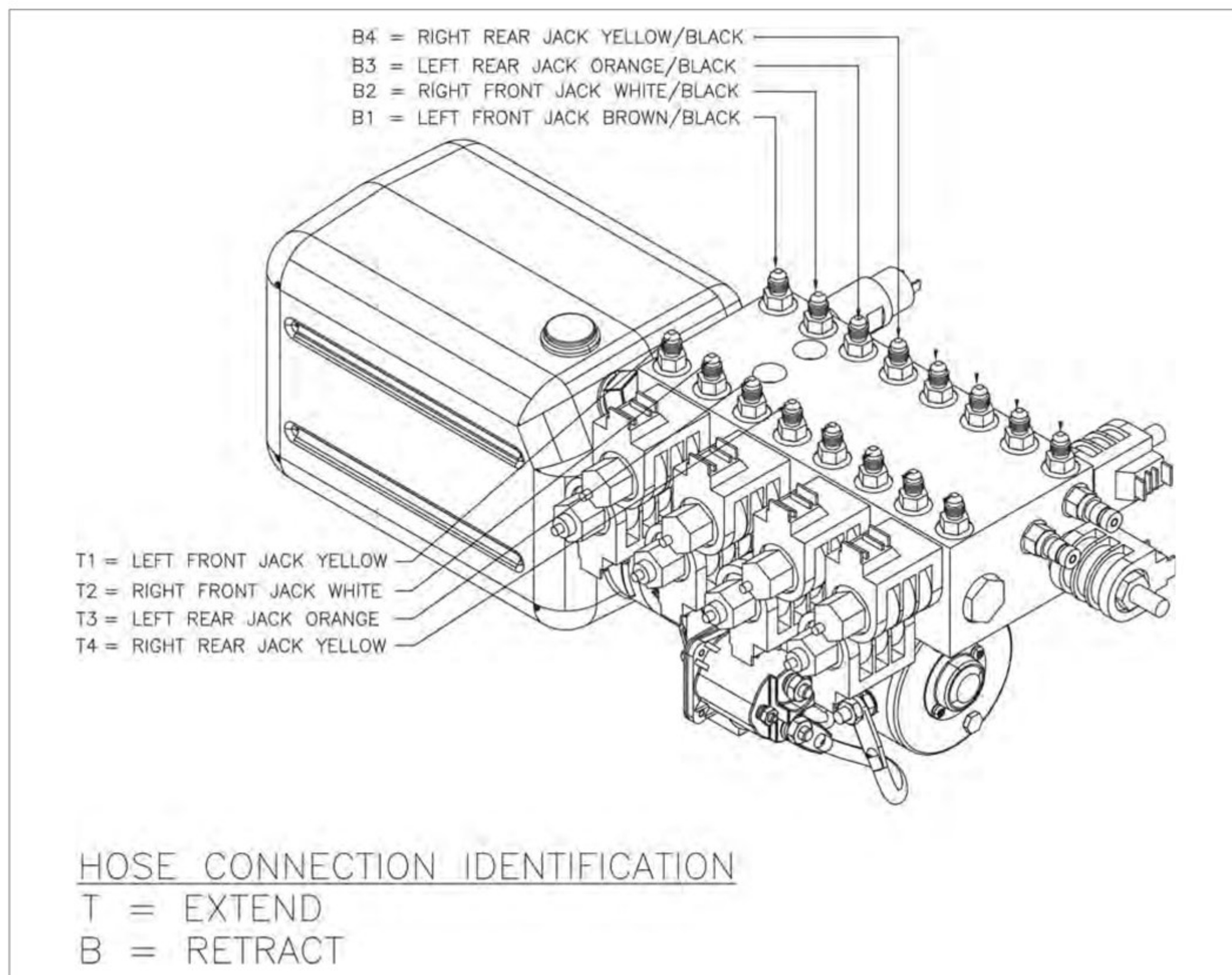

## **DRIVER AND PASSENGER SEATS**

### **! WARNING**

**Do not adjust the seat position while the motorhome is in motion. Never place the driver's seat into a position where visibility would be impaired while driving.**

Both the driver's and passenger's seats have various methods of controlling comfort.

1. **Reclining Back** — A control lever on either the left or right sides of each seat controls the reclining angle of the back rest. Lift up on the lever, lean back to position seat angle in the desired location, then release the lever to lock the back rest in place. To return the backrest to the original upright position, lift up on the control lever. It will automatically return to its normal upright position.

2. **Seat Swivel** — A control lever on the side of both seats controls the swivel function of the seats. Push the lever forward to release the detent on the swing mechanism. Once the lock is released, the seat may be rotated either left or right to any position.
3. **Forward & Back Adjustment** — The forward and back sliding action of the seat is controlled by a lever on the lower left side of the seat. To adjust, pull the lever outward to release the latch, and slide the seat to the desired position. Make sure the seat locks into the position you have selected.
4. **Arm Rests** — Arm rests are provided on both the left and right hand sides of the driver and passenger seats. They may be rotated up and out of the way when not required.

**NOTE:** Sometimes it may be necessary to adjust the sliding position of the seat and the tilt of the back, to enable the seat to be rotated without obstruction from sidewalls or items to the rear. Some models may not allow complete seat rotation.

## **REAR VISION TV MONITOR SYSTEM**

Your motorhome may be equipped with a rear vision TV monitor system. This system gives a televised view of what is behind the motorhome. It is used as an aid in backing the motorhome, and can also be used for greater field of vision when driving in heavy traffic.

The motorhome ignition must be on to power the system. The picture is automatically activated when the motorhome is shifted in reverse. Push the standby switch down to receive the picture at any time. Push the switch out to receive in reverse gear only. Picture brightness can be controlled by rotating the reception switch. A contrast control is also provided to adjust the picture further. Adjust by rotating the switch.

Contrast and bright controls are provided to compensate for changes between day and night use. Push the light/darkness switch in for day use, push again to release for night use. Never operate the monitor in the on position for extended periods of time, this may result in an “image burn” on the monitor.

Make sure to check the mirrors when driving and backing, for a more complete field of vision. The TV camera is equipped with a wide angle lens that can initially present an image that may be deceiving. Make sure to practice backing in a safe place, using the monitor to become accustomed to its operation.

# INTERIOR CONTROLS & OPERATIONS

Your new RV from **Four Winds International** offers virtually all the comforts of home while out on the road. These systems are of the most modern design available, just as the similar systems in your home, however, the RV's systems may be of different design, and construction than those found in your home.

The following instructions are for items inside the recreation vehicle which are general in nature. Instructions for the operation of appliances and conveniences not found here can be found in other sections dealing directly with appliances and systems. Check the index for the location of specific information.

## ***HYDRAULIC SLIDE-OUT ROOM (Equalizer)***



### **CAUTION**

Keep people and obstructions clear of room when operating.

Operating the room with any room-locking device in the locked position can cause personal injury and vehicle damage. It is the operator's responsibility to ensure that all room-locking devices are disengaged before operating the room.

### **CAUTION**

The motorhome must be level prior to operating the slideouts. Failure to do so may result in structural damage to the motorhome.

Extensive damage could occur to the slideout room and awning when extending the slideout room in snow, sleet, ice or freezing rain. In such conditions, if the slideout room is extended, clear the awning and ensure free movement prior to operating the slideout room.

The Pilot and Co-Pilot seats must be in their most forward position, with seat backs in the vertical setting. Also, ensure there is adequate clearance to fully extend the room.

**NOTE:** Erratic operation of the slideout may be caused by low voltage to the hydraulic pump. Be sure to keep house batteries fully charged to prevent erratic operation.

The ignition switch must be in the off position to operate the slide-out system.

#### **ROOM EXTENSION PROCEDURE:**

1. Level the motorhome.
2. Ensure there is proper clearance to fully extend the slideout.
3. Apply the parking brake and activate the coach battery disconnect switch.
4. Unlock the slideout locks by pressing and holding the the LOCK SWITCH in the "UNLOCK" position.

**NOTE:** Rooms with travel locks require both locks to be fully retracted (unlocked) before power to the slideout switch is restored.

5. To extend the slideout press and hold the ROOM CONTROL SWITCH in the "EXTEND" position. When the slideout is fully extended, release the ROOM CONTROL SWITCH.

**NOTE:** Releasing the ROOM CONTROL SWITCH at any time during the extension process will halt the operation of the slideout.

#### **ROOM RETRACTION PROCEDURE:**

1. Ensure proper clearance by clearing any obstruction in the slideout area.
2. Apply the parking brake and turn the ignition to the Accessory position.
3. To retract the slideout, press and hold the ROOM CONTROL SWITCH in the "RETRACT" position. When the slideout is fully retracted, release the ROOM CONTROL SWITCH.

**NOTE:** When retracting slideouts, a delay may be present until the hydraulic pump builds enough pressure to pull the room in. Just continue to press the switch until the room retracts.

4. Lock the slideout locks by pressing and holding the LOCK SWITCH in the "LOCK" position.

#### **MANUAL RETRACTION PROCEDURE:**

### **CAUTION**

Following manual override operation, failure to return all valves to normal position may result in slideout(s) creeping from their retracted (stowed) position. For cartridge valves, rotate the center screw fully counter-clockwise. For directional valves, rotate the red knob until it "snaps" back to the normal position.

In the event of electrical failure, the slideout(s) may be retracted manually by following the procedure below.

1. Locate the hydraulic pump in the front driver's side compartment bay.
2. The individual cartridge valves are clustered together on the side of the pump manifold. (They are labeled 5 thru 8 on the diagram on the next page). Refer to the "Hose Color Identification" to select the proper cartridge valve. Locate the screws on the appropriate cartridge valve(s). Using a small flat blade screwdriver, turn the screw(s) clockwise until all the way in.

**NOTE:** The normal operating position of the screw(s) in the cartridge valve is the counter-clockwise "OUT" position. The only time the valves should be shifted manually is when attempting to operate the slideout(s) via manual override.

3. Locate the red knurled knob on the directional valve DV2. This valve will be on the opposite side of the manifold from the cluster of cartridge valves. Pull the red knob out and turn ¼ turn. The knob will remain in the "OUT" position.

**NOTE:** The normal operating position of the red knob on the directional valve(s) is the “IN” position. The only time the valve should be shifted manually is when attempting to operate the slideout(s) via manual override.

4. Remove the black plastic cap from the top of the motor. Use a small fat head screwdriver. Place the drill with the 7/16” (11mm) hex bit on the manual override shaft located at the top of the motor. Run drill in a clockwise direction at 2000 r.p.m. (minimum). The corresponding slideout(s) will retract.

<b>HOSE COLOR IDENTIFICATION</b>		
<b>LOCATION</b>	<b>EXTEND</b>	<b>RETRACT</b>
SLIDE # 1 (DRIVER FRONT)	GREEN	GREEN / BLACK
SLIDE # 2 (DRIVER REAR)	PURPLE	PURPLE / BLACK
SLIDE # 3 (PASSENGER REAR)	GRAY	GRAY / BLACK
SLIDE # 4 (PASSENGER FRONT)	RED	RED / BLACK

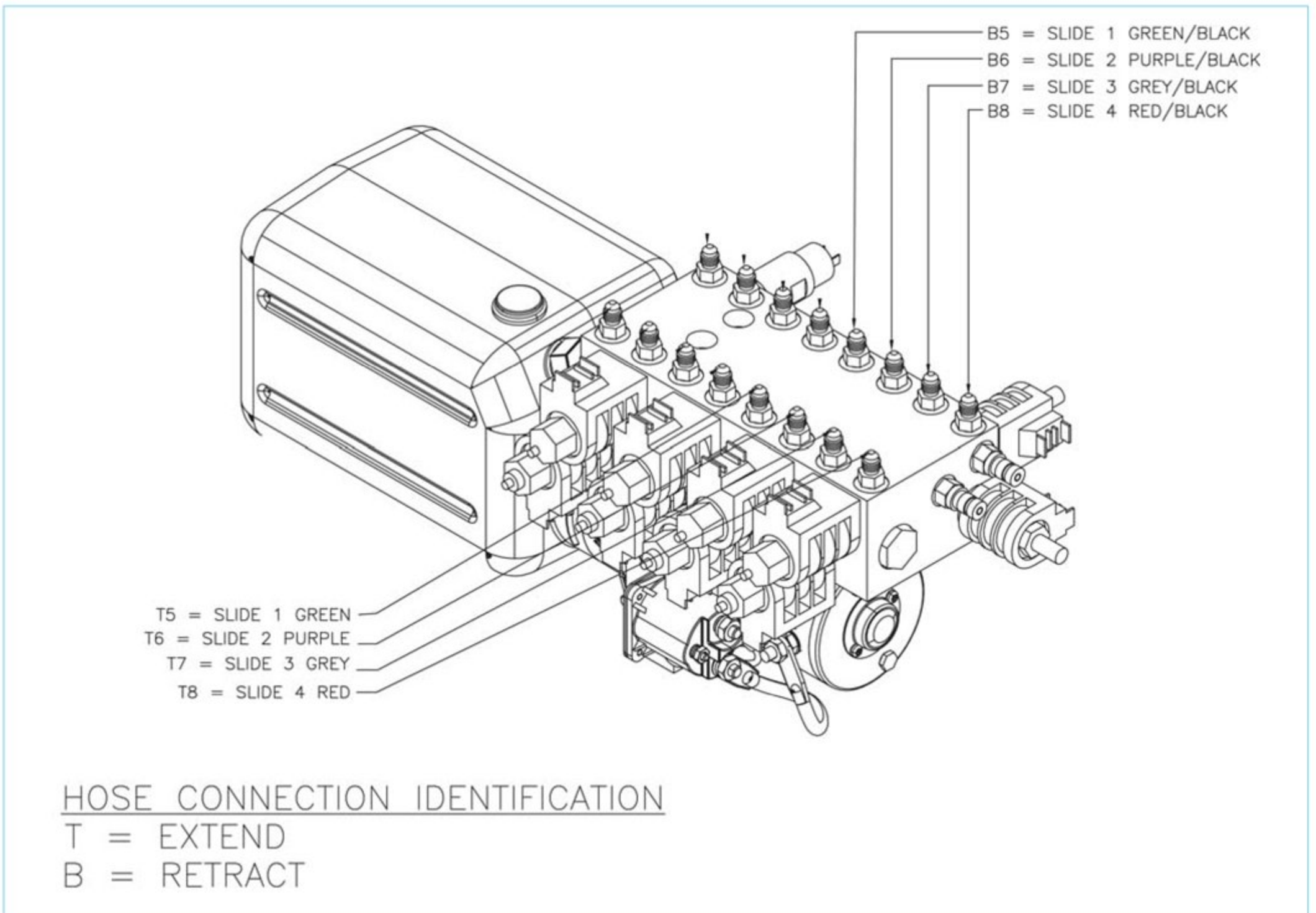

## **NON-HYDRAULIC SLIDE-OUT ROOM (Lippert Components)**

**NOTE:** Refer to the Lippert Components slide-out system operation manual.

### **ROOM EXTEND PROCEDURE**

#### **CAUTION**

Keep people and obstructions clear of room when operating.

Operating the room with any room locking devices in place can cause personal injury and vehicle damage. It is the operator's responsibility to ensure that all room locking devices (if equipped) are disengaged before operating the room.

#### **CAUTION**

Motorhome must be level before extending the slideout room. Failure to do so may result in structural damage to the motorhome.

**BEFORE EXTENDING OR RETRACTING SLIDE-OUT ROOM:** Be sure that the driver's seat is in the forward position and the seat-back is straight up. Slide-out room will contact chair if chair is improperly positioned.

1. Level the unit and unlock all room-locking devices. (If so equipped) **Note:** Make sure that there is adequate clearance to fully extend the room.
2. Apply the parking brake
3. To extend the room, press and hold the ROOM CONTROL SWITCH in the "OUT" position. When the room is fully extended, release the ROOM CONTROL SWITCH. **Note:** Releasing the ROOM CONTROL SWITCH will halt the operation of the room.

### **ROOM RETRACT PROCEDURE**

1. Make sure to clear any obstruction in the slide-out area, and set the parking brake.
2. To retract the room, press and hold the ROOM CONTROL SWITCH in the "IN" position. When the room is fully retracted, release the ROOM CONTROL SWITCH.
3. Install the room locking devices if equipped.
4. If the room will not retract, see the MANUAL RETRACT PROCEDURE (NON HYDRAULIC)

### **MANUAL ROOM RETRACTION PROCEDURE (Non-Hydraulic)**

**(Use only when the room will not retract with the room control switch)**

The room can be retracted manually if an electrical failure prevents the room from being retracted using the ROOM CONTROL SWITCH. For normal retract sequence see the ROOM RETRACT PROCEDURE.

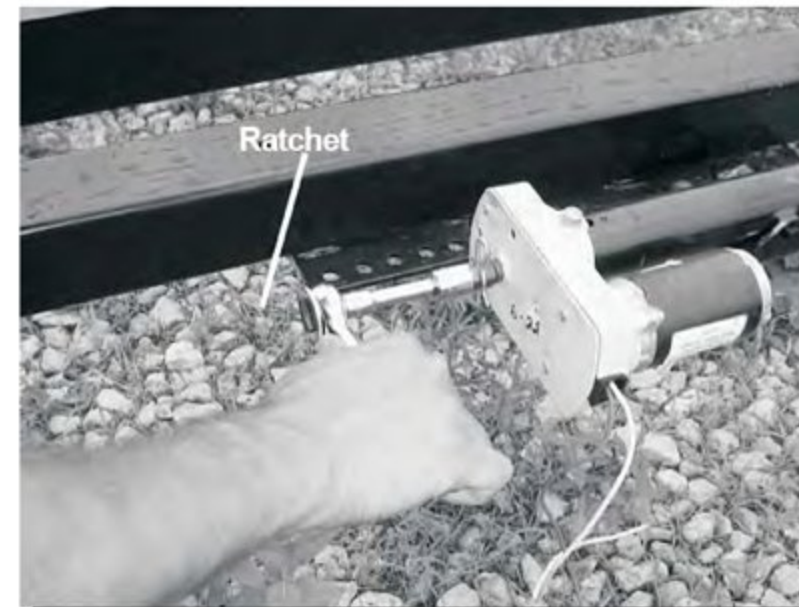
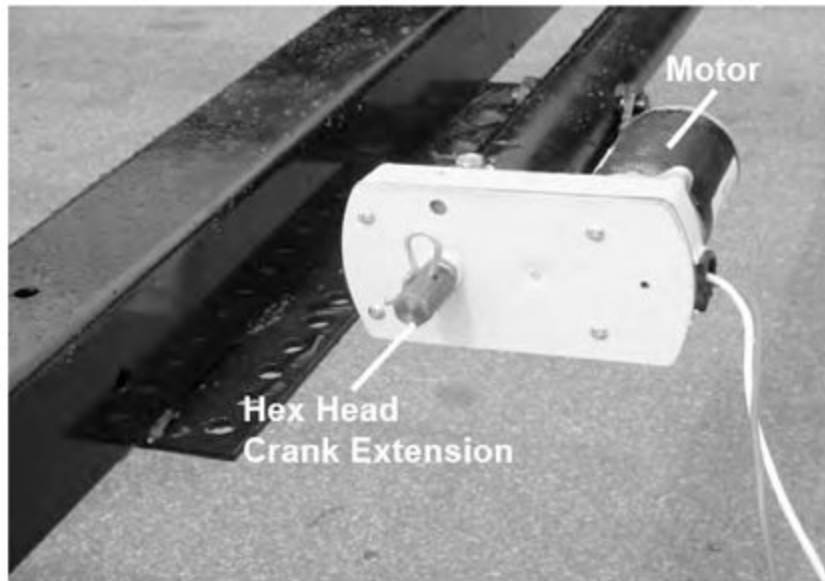

1. Make sure coach disconnect is off and clear any obstruction in the slide out area.
2. Locate the electric motor and gear drive assembly. This may be under a couch, bed, etc. You may also have to remove an access panel if applicable.
3. Depending on the slide mechanism, either a 9/16" or 5/8" wrench will be needed. Rotate the manual override shaft enough to see if it will need to be rotated clockwise or counterclockwise to retract the slide room.
4. Rotate the shaft until the room is retracted fully.
5. The system should be repaired before using again.

## **WINDOWS**

### **! WARNING**

**To avoid exhaust gas entry into the motorhome, keep windows closed when the chassis or generator engines are running.**

All the windows that open in the recreation vehicle are operated by sliding them back and forth. To operate, pivot the latch to release it from the locked position, and slide the window to open. When closing, slide the window fully closed, and pivot the latch back to the fully locked position. The screens will also slide open and closed if required for an emergency exit.

**NOTE:** Check window sealant during normal coach washing and per the Care & Maintenance section of this manual.

## **DOORS, DRAWERS AND STORAGE COMPARTMENTS**

### **! WARNING**

**Make sure before operating your recreation vehicle, that all cabinet doors and drawers are closed, and cabinet contents are secure. Retract and secure sliding doors in the bath area, as well as the bath door, to prevent noise and/or damage while traveling.**



## **WARNING**

**Use caution when lowering the bed to keep hands and fingers at the end ledge provided; and not on the side or further back than necessary, where you may encounter pinch points.**

Cabinet and closet doors in the recreation vehicle have door fasteners, or pneumatic stops, which prevent them from accidentally opening during travel. Drawers throughout the recreation vehicle have travel stops which keep them from sliding out when in motion (under normal driving conditions).

To open drawers, lift up first, then slideout. When closing drawers, make sure they drop slightly into the travel position.

**Under Sofa Storage (Some Models)** —Access the available storage under the sofa by lifting the front seat section and pulling towards you. Do not lay seat down completely.

**Under the Bed Storage** — There may be a large storage area located under the bed. It is accessed by grasping the end ledge at the foot of the bed and lifting. Make sure before lifting, that there is nothing on the bed that will restrict its movement, or add extra weight.

Pneumatic struts on both sides of the storage compartment aid both in lifting, and holding the bed in the upright position. When storing items under the bed, be sure to leave space in the storage compartment for the struts when the bed is closed.

When lowering the bed, there will be some resistance felt at first, because of the struts. Be sure to keep both hands on the end ledge all the way down to the closed position to avoid having the bed suddenly drop shut.

Store items in the areas designated for storage. DO NOT store anything in the area reserved for the converter and electrical panels or the water tank and pump.

## **SEATING, TABLES AND ADDITIONAL BEDS**

## **WARNING**

**The sleeping accommodations in this vehicle are designed for occupancy only while the vehicle is NOT in motion. All occupants in this vehicle must be seated at a designated seating position and must wear seat belts at all times while this vehicle is in motion. Failure to do so may result in serious injury.**

**NOTE:** *Seat belts have been provided at most seating locations within your vehicle to allow the user the flexibility and convenience to choose which seat location they would like to occupy. However, it is not intended for all seats to be simultaneously occupied while the vehicle is in motion without regard to the total loaded weight of the vehicle.*

**DO NOT EXCEED THE CARRYING CAPACITY OF THIS VEHICLE.**

Depending on which model and options you have in your recreation vehicle, seating will include some combination of the following:

1. **Sofa** — The sofa will comfortably seat three adults. It also converts to a bed by lifting the front section and pulling toward you. The sofa back follows and pivots down into a prone position. To reconvert back to a sofa, lift the front and push back and down into place. The sofa back will follow and pivot up into its upright position automatically. When reconverting to the sofa configuration, make sure to pull the seat belts out to their usable positions.
2. **Lounge Chair** — The lounge chair has controls on the bottom right and left sides under the chair skirt that controls the swivel and side to side action of the chair.
3. **Dinette** — The dinette will seat four people. Storage and/or various systems components can be accessed from above by removing the seat cushions and lifting the seat supports.

**Pedestal Type Dinette** — The dinette can also be converted into an additional bed if required. To convert, lift the table top off of the two support posts. Remove the support posts from the floor and lay them down between the seats. Insert the table top between the seats on the ledges provided. Loosen the seat cushion from the Velcro fasteners and slide each together to form the bed. Reverse this process when reconverting to the dinette configuration.

**Wall Mounted Type Dinette** — This dinette can also be converted into an additional bed. Lift the aisle side of the table and pinch in the pins on the table leg to collapse the leg. Unhook from side wall and swing into place. The table supports on the dinette base. Loosen the seat cushion from the Velcro fasteners and slide each together to form the bed. Reverse this process when reconverting to the dinette configuration.

4. **Fold-Down Lounge Table** — This table is stored in a folded position next to the lounge chair. To raise for use, pull out on the bottom to release it from its securing catch, and swing up. When raised, reach under the table and swing the supporting leg down until it locks into position. Adjust the length of the support leg, so that the table will be level when resting on it. To adjust the support leg length, pull back on the spring clip, releasing the detent from the adjustment hole it is presently in. While holding the spring clip back, slide the leg to the desired length, then release the spring, allowing the detent to lock into the new hole.

To fold back for storage, reverse the previous procedure; shortening the support leg, and folding the leg up against the bottom of the table top. Lower the table top, and push in on the bottom to secure it into the catch that keeps the table from moving while traveling.

5. **Free Standing Dinette Chairs** — Some models have free standing dinette chairs. Since these chairs are not permanently attached to the floor, and not equipped with seat belts, they should not be occupied while the recreation vehicle is in motion. These chairs should be stored securely while the vehicle is in motion.

## **WARNING**

**These chairs are not for occupancy while vehicle is in motion. These chairs are not permanently attached to the floor. All occupants in this vehicle must be seated at a designated seating position and must wear seat belts at all times while this vehicle is in motion. Failure to do so may result in serious injury.**

## **OVERHEAD VENTS**

Vents are provided in the recreation vehicle to circulate fresh air and exhaust odors.

**Bathroom Power Vent** — The power bath vent has dual controls to operate both opening and closing, as well as the exhaust fan. A hand crank controls opening and closing and adjustment of the vent cover, while a push button turns the exhaust fan on and off. Make sure to turn the fan off before closing the vent. Also be sure to remove any debris that falls into the vent that may restrict its operation.

## EXTERIOR OPERATIONS

The following instructions are for items on the outside of the recreation vehicle. Instructions for the operation of appliances and conveniences not found here may be found in other sections dealing directly with appliances and systems. Check the index for the location of specific information.

### **ENTRY DOOR**

The entry door consists of both an exterior door and a screen door used for ventilation when the recreation vehicle is parked.

DO NOT attempt to drive the recreation vehicle with the doors open. DO NOT drive the recreation vehicle with the outer door open and the screen door closed. The doors may be damaged, and it is a safety hazard.

When driving, it is a good idea to keep the door locked to prevent uninvited entrance from the outside when stopped. Two types of locks may be provided with the outer door. The handle lock for normal security, and a dead bolt lock for additional security.

The screen door can be attached to the outer door. A sliding panel on the screen door permits access to the handle on the outer door to prevent unnecessary handling of both doors.

Separate keys are provided for both types of door locks. It is a good idea to keep a record of the key numbers in a safe place, should it become necessary to have duplicate keys made.

### **STEP**

A manual operating step is provided as standard equipment on most recreation vehicles. To extend the step, lift up on the step and pull forward. The step is held in place by a detent on each side. To retract the step, lift the step out of the detent, and push back to the original stored position. Make sure that the step is secure in the retracted position before moving the recreation vehicle.

Make sure to keep your fingers away from the sliding mechanism when extending or retracting the step.

### **POWER STEP**

## CAUTION

**If the vehicle is driven with the step in the extended position, there is the possibility of causing major damage to both the step and the vehicle.**

### **OPERATION FOR STEPS WITH CONTROL UNIT:**

1. With the entrance door open, turn the override switch to the OFF position. Close the door. The step should retract and lock in the 'up' position.
2. Open the door. The step should extend and lock in the 'down' position with the understep light illuminated.

**NOTE: The understep light operation is as follows:**

- The light is ON when the step is extended.
  - The light is OFF when the step is retracted.
  - If the override switch is OFF and the step is extended by opening the door and the door is left open, the light will turn OFF after five minutes.
  - The understep light is not available on all step models.
3. Turn the override switch to the ON position. The step should remain in the extended position with the understep light OFF when the door is closed.
  4. With the override switch turned ON, the step extended, and the entrance door closed, turn the vehicle ignition ON. The ignition override system will go into effect and the step will automatically retract.

**NOTE:** If the yellow wire from the four-way connector is not connected to an ignition power source, the ignition safety system will be inoperative and the step will remain in the extended position. In this case, the override switch must be turned OFF for the step to retract.

5. Turn the vehicle ignition OFF and open the door. The step will extend and lock in the 'down' position. This is the 'Auto Extend' feature. When the vehicle ignition is turned ON, the step will always activate with the door movement, regardless of the override switch position.

## **STORAGE**



### **CAUTION**

**When closing the storage compartment doors, make sure that hands and fingers are clear of hinges and openings.**

Your recreation vehicle is equipped with numerous outside storage compartments. Each door can be locked for security.

Do not overload outside storage compartments with heavy densely packed items. Remember that any weight added to the recreation vehicle affects the overall vehicle weight. Also remember to check side to side weights, since putting an extremely heavy item on one side or the other will effect proper load distribution. Check the index for additional information regarding weighing and loading of the recreation vehicle.

Keep any emergency items stored in outside storage compartments easily available, where they can be reached without unloading the entire contents of the compartment.

**NOTE:** Make sure storage compartment doors are closed, latched, and contents secure before starting and moving the recreation vehicle.

## **LADDER / ROOF ACCESS**



### **WARNING**

**Do not climb on or walk on the roof while wet. The roof could be very slippery causing you to fall, which can result in serious injury or death. Do not use the roof as an observation platform or storage area, as it is not designed for these purposes.**

### **CAUTION**

**Do not step on the very rear portion of the roof where the fiberglass from the rear walls wraps to the roof.**

The exterior rear ladder provides access to the roof for maintenance of the roof and roof mounted items only. When ascending and descending the ladder, ensure the ladder is clear of debris, such as water, ice and other slippery substances. Always wear shoes that provide good traction, and do not wear sandals or other types of slip-on footwear when ascending or descending the ladder. Four Winds International recommends utilizing your local service center for all roof inspection and repairs.

**NOTE:** *The rear ladder maximum weight capacity is 250 lbs.*

### **SLIDE OUT AWNING:**

The Slideout Topper will automatically open and close as the slideout room opens and closes. Because the awning is level, water may puddle on top of the canopy. As the slideout room is closed and the awning rolls up, these puddles may spill over the sides of the awning.

**NOTE:** *For detailed information regarding the Slideout Topper Awning refer to the A&E Systems, Slide Topper Installation & Operating Instructions Manual.*

### **MANUAL PATIO AWNING:**

#### **To Extend:**

- Release both travel straps (one on each arm, about midway up) by squeezing the travel strap buckle to pull both pieces apart.
- Using the provided awning rod, rotate the Safe-T-Lock lever up to the UNLOCK/OPEN position.
- Hook the awning rod into the pull strap loop securely and pull the awning out. Once extended, slide the pull strap to the right and wrap the strap around the awning arm.

**NOTE:** *Prior to closing, remove tie downs and screen if used. Ensure that the travel strap and buckle are clear of the back channel.*

### To Retract:

- Unwrap the pull strap from the awning arm and slide it slightly to the left.
- With one hand, firmly grip the awning pull strap and gently pull down, while at the same time, using the awning rod to rotate the Safe-T-Lock to the UNLOCK/CLOSE position.
- While holding the pull strap firmly, hook the awning rod into the pull strap loop and slowly allow the awning to retract, controlling the speed with the awning rod in hand.
- Once the awning has fully retracted, reconnect the travel straps and tighten by pulling on the loose end of the strap.

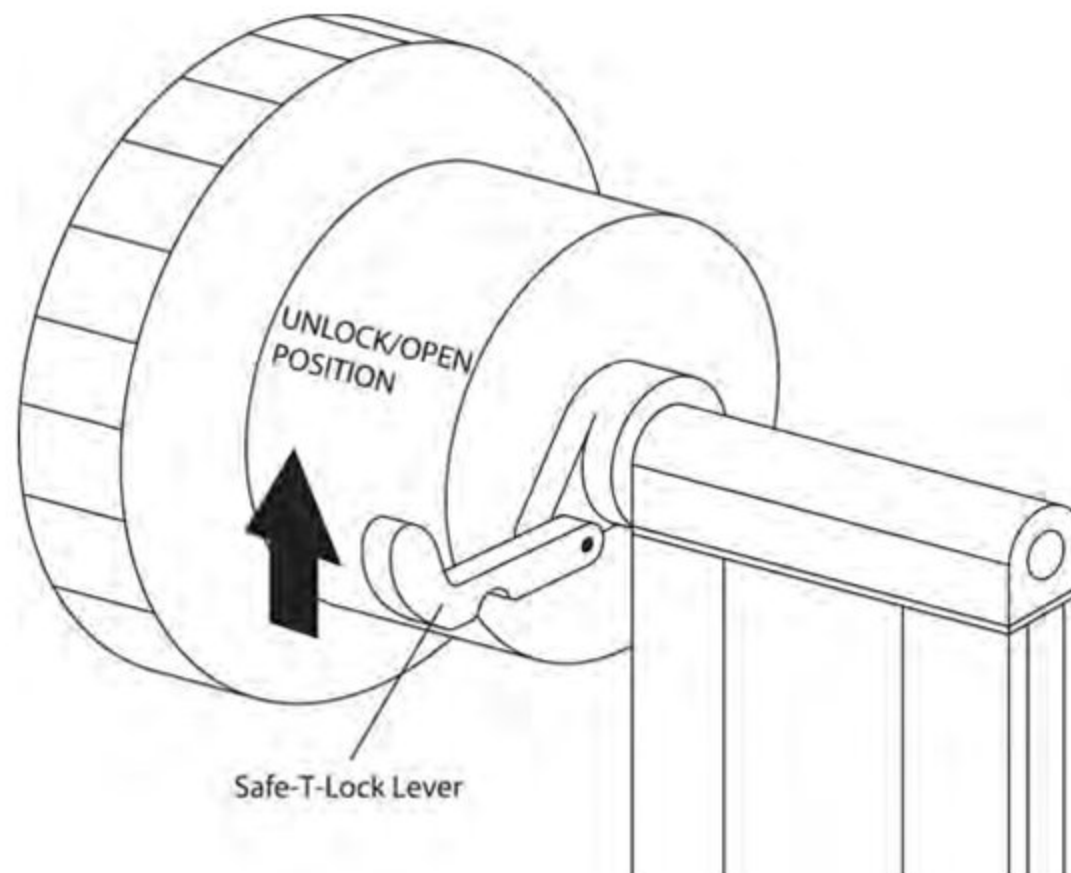

### AUTOMATIC PATIO AWNING:

#### To Extend:

- Press and hold the remote switch (located on the front of the passenger arm rest) in the extend position until the awning is fully open or utilize the remote control.

NOTE: Do not press more than one "EXTEND" button at the same time. Awning will not work and/or may cause control box fuse to blow.

#### To Retract:

- Press and hold the remote switch in the retract position. When awning is fully closed release the switch.

**NOTE:** Do not press more than one "RETRACT" button at the same time. Awning will not work and/or may cause control box fuse to blow.

**NOTE:** In the event of power loss or awning motor failure the Automatic Patio Awning can be retracted as explained below. If you do not feel comfortable performing this procedure, contact the nearest authorized service center for assistance. Do not drive the motorhome with the awning in the extended position.

#### Manually Closing the Automatic Awning:

- Two people will be needed to perform this procedure.
- Slide the provided pull strap into the utility slot of the Fabric Roller Tube Assembly.
- Make sure that one person is securely holding onto the pull strap, while the other

- person removes the bolt in the top of the right top casting. Once the bolt is removed the FRTA will want to roll in on its own. This is why it is very important to hold the strap securely.

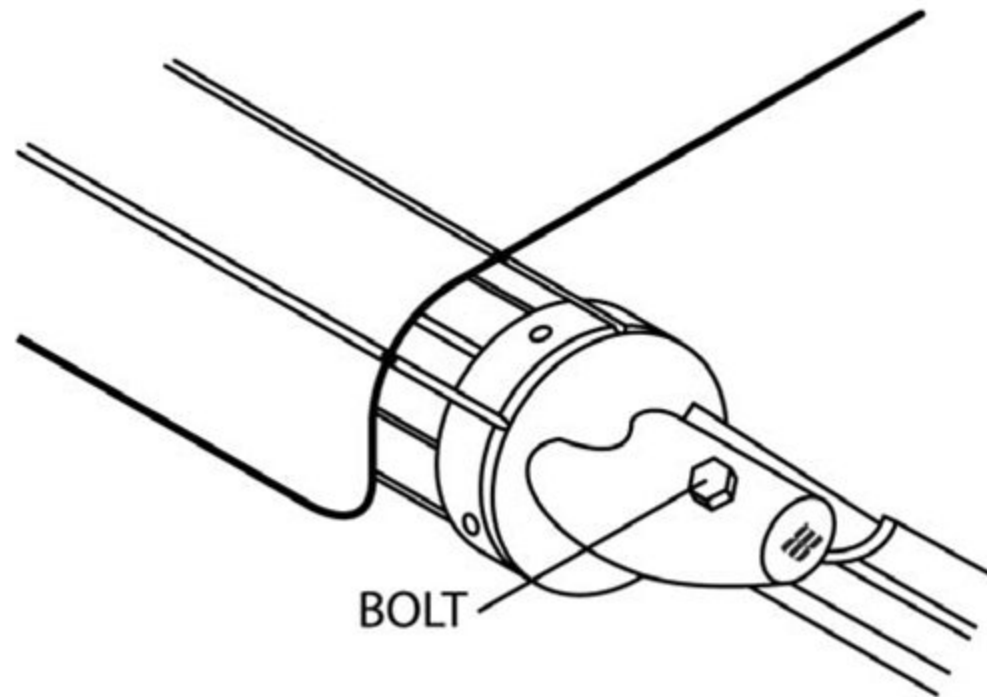

- While holding the strap, let the FRTA slowly retract until it is in the closed position.
- Once the awning is in the closed position, align the hole where the bolt was removed and reinstall to secure the awning. The bolt must be reinstalled to prevent the awning from opening during travel.

**NOTE:** *The awning must be serviced by a Dometic Service Center or a qualified service technician before attempting to open the awning after this procedure has been performed.*

**NOTE:** *If threatening weather approaches, you need to retract all awnings. If the awnings are rolled up wet, open them back up as soon as possible to allow them to dry. Also, do not drive during periods of high winds.*





# LP GAS SYSTEM

## GENERAL INFORMATION

### **WARNING**

LP Gas is highly volatile and extremely explosive. Do not use matches or a flame to test for leaks. Use only approved LP Gas leak testing solution for leak detection. Unapproved solutions can damage copper tubing and brass fittings. Never attempt to adjust LP Gas regulators. Only qualified personnel should perform any maintenance or repair to the LP Gas system.

The liquid petroleum (LP) gas system in your recreation vehicle furnishes the fuel for cooking, heating, and hot water. LP gas can also be used as an alternate energy source for refrigeration. LP gas is a clean, efficient, safe form of energy when proper handling and safety precautions are observed. It enables you to enjoy a comfortable lifestyle where other forms of energy are not easily utilized.

The gas is stored under extreme pressure in the tank, with space in the tank to allow for expansion into vapor. This vapor is reduced in pressure by passing through a regulator. This reduction in pressure is a two step process which assures consistent pressure for use, regardless of outside temperatures, weather, or altitude.

Your LP system is designed to accept either LP Gas or butane. However, since butane vaporizes at about 32°F, it can only be used in areas where you can be sure of higher temperatures. LP Gas vaporizes at approximately -40°F. There are blends of LP Gas and butane available, which will vary in the temperature at which it vaporizes. When filling your tank, select an LP gas that has a boiling point about 40° lower than temperatures you expect to travel in. Talk to your dealer, or your local LP gas supplier about what you should be using.

**NOTE:** Even though the tank is equipped with an automatic 80% shut-off which prevents overfilling beyond 80% tank capacity, it is a good idea to have the supplier monitor the 20% liquid level gauge, and stop the filling process if liquid does appear.

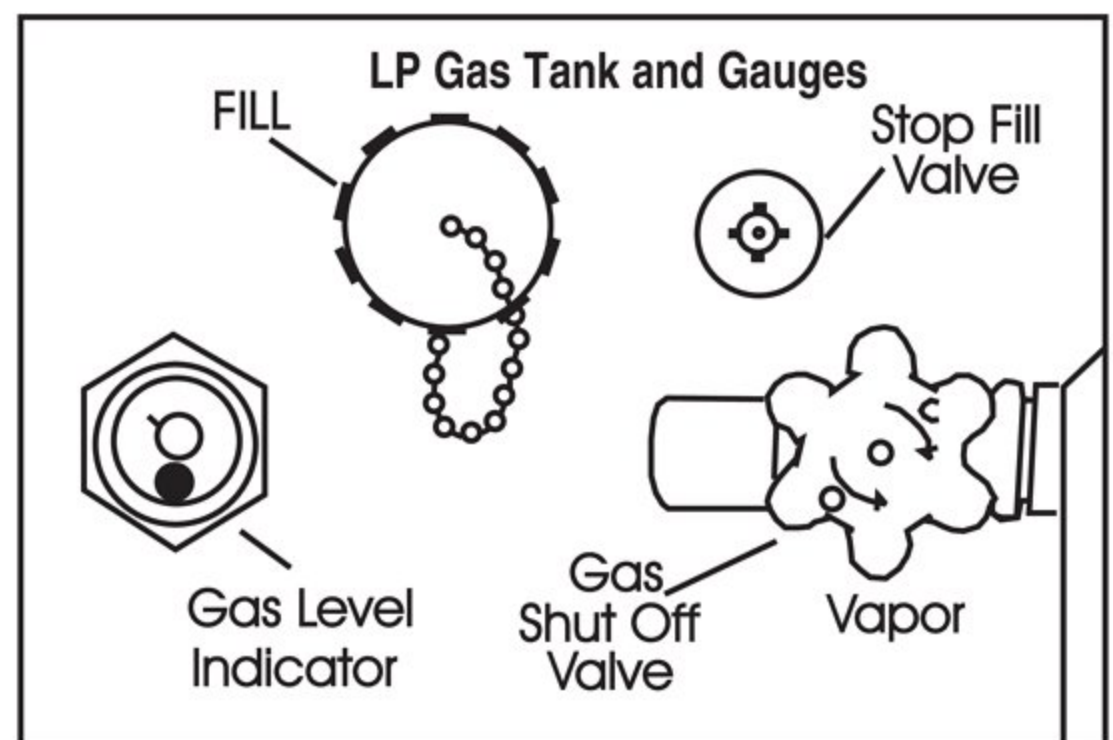

## **FILLING THE LP GAS TANK**



### **WARNING**

**Make sure that the tank is not filled beyond the 80% liquid level. If the tank has been overfilled, make sure the LP supplier bleeds out the excess. Overfilling the LP gas container does not allow for the necessary 20% vapor expansion space that can result in uncontrolled gas flow which can cause fire or explosion.**

**Make sure the tank service valve is accessible at all times. In an emergency, it may be necessary to shut off the valve quickly.**

1. Before entering the LP gas bulk plant or service station, make sure all pilot lights are extinguished. Shut off gas to all appliances by closing the LP gas main shut off valve.
2. Extinguish open flames and smoking materials.
3. Never remove the LP gas tank from the motorhome. Always drive the motorhome to the gas supplier to fill.
4. Have the supplier connect the fill nozzle to your tank fill connection.
5. Always remember to close the supply valve, and open the 20% liquid level valve.
6. Never use a wrench to close the service valve or 20% gauge. If when closing by hand, leaking occurs, have the valve repaired or replaced.
7. Drive at least one mile from the LP supplier before relighting pilot lights or appliances. This will allow any minimal leakage which occurred while filling the tank to dissipate. DO NOT light pilot lights if you continue to smell LP gas. Allow the recreation vehicle to ventilate for 30 minutes. If you still detect LP gas odor, have the source of the leak located and repaired.

Never use any other tank than the one furnished with your recreation vehicle. If the tank must be replaced, check with your dealer for correct tank specifications and replacement procedure.

## **LP GAS REGULATOR**



### **WARNING**

**Never alter the positioning of the regulator. LP gas regulators must always be installed with the diaphragm vent facing downward. Also make sure to keep the regulator cover in place to minimize vent blockage which could result in excessive gas pressure causing fire or explosion. Do not rely upon being able to smell LP gas leaks, as the odor may not be sufficiently strong to detect.**

The regulator reduces the pressure of the LP gas vapor from the pressure in the tank, to the pressure required for use at the appliances. This reduction in pressure is performed by a two-stage regulator. Two regulators are used in the same body to reduce the pressure of the LP gas in the tank for use by the appliances in the recreation vehicle. The regulator seldom requires service, but it should always be protected from the elements and extremes of hot and cold.

The high pressure regulator (first stage) is used to reduce the pressure to approximately 10 to 13 PSI before sending it along to the low pressure regulator (second stage). This second stage regulator reduces the pressure further to 11 inches water column, or 6.35 ounces per square inch.

The two stage regulator does not have to work as hard since the second stage receives consistent pressure rather than inlet pressure which varies. The result is an efficient safer system that helps to eliminate problems such as freeze up and pilot outages.

The regulator has been preset by the manufacturer of the regulator, and adjustment should not be necessary. If adjustment should be required however, DO NOT attempt to adjust it yourself. Adjustment must be made with special equipment by a qualified LP gas service technician.

Have the regulator checked annually, or whenever you suspect a problem. The correct line pressure should be 6-1/4 oz., or 11 inches of water column.

Because air is required for proper operation of the regulator, it is very important that the regulator vent is kept clean and free of dirt and debris. This is why it is necessary to keep the vent facing downward and the regulator covered to protect it from contamination. A toothbrush can be used to clean the vent if it becomes clogged by foreign matter.

During cold weather, it is important to keep ice from forming in the regulator, which will shut off the flow of LP gas to your appliances. Have the supplier add hydrous Methanol when filling your tank for use during cold weather.

Regulator freeze up can occur in any weather if there is moisture in the tank, or if the tank has been overfilled. Always use moisture-free LP gas, and make sure the tank has not been filled beyond 80% of capacity. If moisture has entered the tank, have the tank purged, or have hydrous methanol added by an authorized LP supplier.

If you believe a regulator has been damaged or otherwise is not functioning, have it replaced by a competent serviceman.

## **REGULATOR FREEZE-UP**

The term regulator freeze-up is a misleading one. Regulators and LP gas do not freeze. However, the moisture that can be contained in the gas will freeze as the gas expands and cools passing through the regulator. This freezing of the moisture in the gas can build up and partially or totally block the passage of the gas through the regulator. Freezing can also occur when outside temperatures are low enough to contribute to the freezing of the moisture in the gas.

The source of the moisture is varied. It can occur at the refinery or gas bulk plant, in the cars used to transport the gas, or even within your own LP tanks. Moisture in an LP tank can occur when a tank service valve is left open, allowing moist air to enter and become trapped.

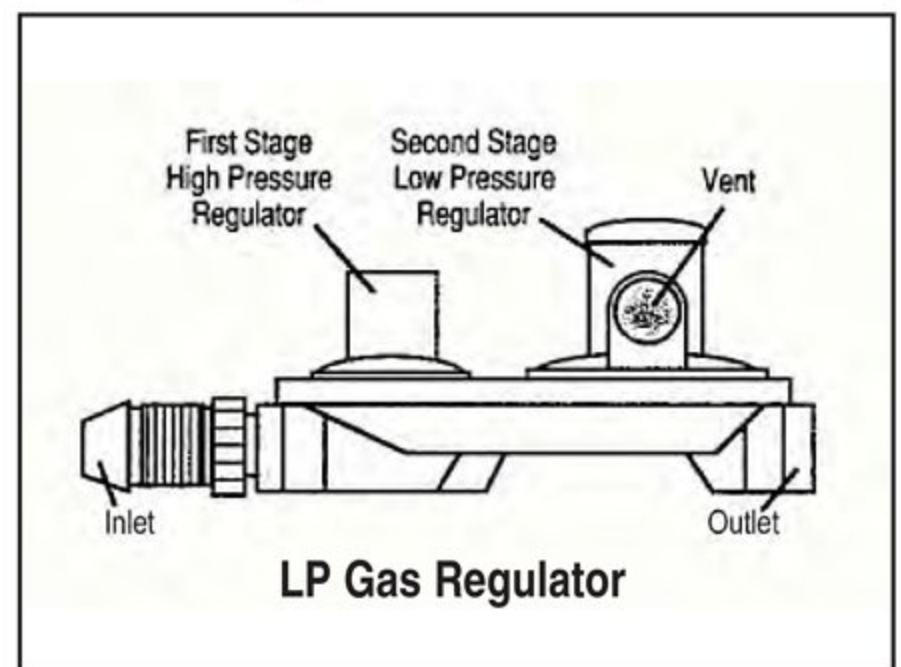

A two-stage regulator helps to reduce the possibility of freeze-up because of its larger orifice size, and the fact that heat is transferred through the walls of two regulators instead of just one.

There are several steps that can be taken to inhibit or prevent this from happening:

1. Make sure that your LP tank is free of moisture before refilling.
2. DO NOT overfill the LP tank.
3. Make sure to keep the service valve on an empty tank closed.
4. If freezing has occurred, have your LP dealer purge the LP tank before refilling.
5. Add hydrous methanol or other approved LP antifreeze or deicing agent to the LP tank.
6. Keep the regulator covered at all times.

**NOTE:** *If freeze-up does occur, shut off the LP gas at the tank. A frozen regulator may permit LP gas to flow at high pressure, resulting in leaks at appliances or in the lines. If freeze-up does occur, NEVER attempt to thaw with an open flame. A small light bulb can sometimes be useful to provide heat and aid the thawing process. Once thawed, be sure to take the proper steps to prevent a reoccurrence. Have the system checked by your LP supplier if freeze-up continues.*

## **OTHER COLD WEATHER FACTORS**

Remember that as outside temperatures drop, the BTU value of the LP gas is lessened, since the colder liquid LP in the tanks requires the heat from the surrounding air to vaporize. This lowering of BTU value can significantly affect the performance of the system. You can help insure proper performance by keeping your LP tanks as full as possible in cold weather, and reviewing the BTU/hr rating plates on LP appliances for proper LP management.

## **HOSES, PIPES, TUBES AND FITTINGS**

The hoses, pipes, tubes, and fittings used in your LP system are designed to withstand pressures far exceeding those of the LP system. However, because environment and time can both contribute to the deterioration of these components, they must be inspected for wear at regular intervals. Be sure to inspect the hose before each season, and when having the tank refilled. Look for signs of deterioration such as cracks or loss of flexibility. When replacing the hose or other LP components, make sure to always replace them with components of the same type and rating (check with your dealer).

Fittings are used to connect the various system components to each other. The P.O.L. fitting at the end of the LP supply hose is made of brass so that pipe sealants are not necessary to prevent leaking. It also has a left-handed thread, which means that it is turned clockwise to remove, and counterclockwise to tighten. The P.O.L. Fitting has been designed to help restrict the flow of LP gas in the event of a regulator failure, or hose malfunction.

## CHECKING THE LP GAS SYSTEM FOR LEAKS

### WARNING

Never check for leaks with an open flame. The scent of LP gas (a garlic-like odor) is actually ethyl mercaptan, an additive that allows you to detect the presence of a leak, since LP gas is naturally odorless. Do not rely upon being able to detect the smell of the gas, as the odor may fade.

Road vibration can loosen LP gas fittings. It is important to check your LP system for leaks at least every 5,000 miles, and whenever the tank is filled. It is also a good idea to have your entire LP gas system checked annually by a qualified LP gas service representative.

Use the following steps when checking the system for leaks:

- Open all the windows and vents.
- Open the gas tank service valve.
- Use non-ammoniated, non-chlorinated soap solution, or an approved leak detection solution on all line connections (ammoniated soap solutions can cause cracking on copper or brass lines and fittings).
- If a leak is detected, tighten the connection with two open end wrenches until the bubbling stops. DO NOT over tighten, or use excessive force. If the leak continues, contact your recreation vehicle dealer, or a qualified LP gas service representative.

## LP GAS LEAK DETECTION SYSTEM (C.C.I. Model 40-442A)

### WARNING

Test the operation of this detector after the vehicle has been in storage, before each trip and at least once per week during use.

The following instructions are for the C.C.I. Model Pre-Tell 1 LP Gas Leak Detector. If your vehicle is equipped with a different brand, refer to the owner's manual for that specific information.

### HOW TO OPERATE

Your Pre-Tell 1 is powered at all times when the battery is connected. If your coach is equipped with a master cutoff switch, the detector will be turned off when this switch is turned OFF. When the detector is powered by connecting the battery or turning ON the master cutoff switch, the green indicator will light. After 60 seconds, the detector will begin monitoring the air in your coach for

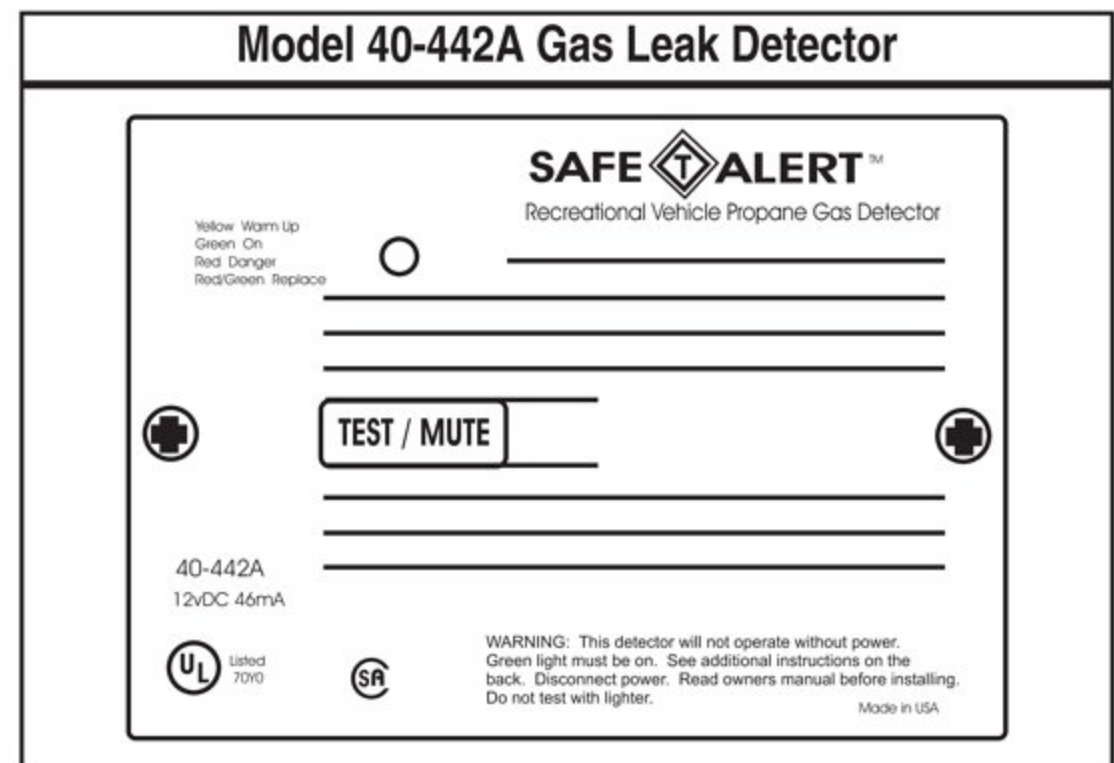

combustible vapors. The LP Gas you use to cook, refrigerate, and heat is combustible. Should a leak occur, your Pre-Tell 1 will produce a pulsating alert sound when the gas reaches the detector. This alert will continue to sound until the gas has dissipated or until the reset button is pressed. **When the alert sounds, open all doors and major windows to air out the coach and turn the gas off at the tank. Do not reenter the coach until the alert stops sounding. If the alert sounds a second time after the gas is turned back on, leave the gas off and have a qualified LP Gas Dealer or RV Service Center make the necessary repairs.** The reset button only stops the alert from sounding for 60 seconds. **This device is intended for detection of LP Gas ONLY.**

## **HOW TO TEST**

Simply press the Test switch any time during the warm up cycle or while in normal operation. The LED should flash red and the alarm should sound. Release the switch. **THIS IS THE ONLY WAY YOU SHOULD TEST YOUR DETECTOR.** The test feature checks the full operation of the detector. If this detector does not test properly contact your RV Dealer or a qualified LP Gas Service Center. If service is not available in your area, call CCI.

**CALL (800) 521-5228**

**if you have any questions about your C.C.I. LP Gas Detector.**

## **ABOUT YOUR LP GAS DETECTOR**

Liquid Petroleum (LP) Gas is heavier than air and will settle to the lowest point which is generally the floor of your coach. The detector is also sensitive to other fumes such as hair spray of which most contain butane as the propellant. Butane, like LP Gas, is heavier than air and will settle to the floor level where it will be detected. When this occurs, press the reset button to stop the alert sound for 60 seconds.

Other combustibles which will be detected include alcohol, liquor, deodorants, colognes, perfumes, wine, adhesives, lacquer, kerosene, gasoline, glues, most of all cleaning agents and the propellants of aerosol cans. Most are lighter than air in their vapor state and will only be detected when the coach is closed up. Glues and adhesives may exhaust hydrocarbon vapors for months after they are applied. They are easily activated by high temperatures. Close your coach up on a hot day and the chemicals used in its construction may be detected for months after the coach was manufactured.

Your gas detector is powered by your RV battery and/or your converter, it draws less current than drawn by one instrument panel lamp. Your detector will operate to detect gas until your battery is drained down to 10 volts. (Your low battery condition is 10.4 volts.) If the power source (battery and/or converter) is disconnected, or if the power is otherwise interrupted, the detector will not operate.

Your Pre-Tell 1 Gas Detector has a self check circuit which runs at all times when the detector is powered. In the event that the circuitry fails, a failure alarm will sound. It is a continuous series of short beep tones between long intervals and is distinctively different from the alert sound.

## **MOST COMMON CAUSES OF APPARENT MALFUNCTION**

- 1. New Coach Odor:** The glues and other materials used in manufacturing the coach produce vapors which may be detected when the coach is closed up on a warm day. *Air out the coach thoroughly.*

- Keeps Beeping:** The gas detector beeps about once every minute,— even when it is turned off. The problem is a weak battery in the smoke detector which causes the smoke detector to produce short beeps which sound similar to the alert sound of the LP Gas Detector. This is a high pitch tone and bounces off the walls, making its location very hard to pinpoint. *Replace the battery in the smoke detector.*

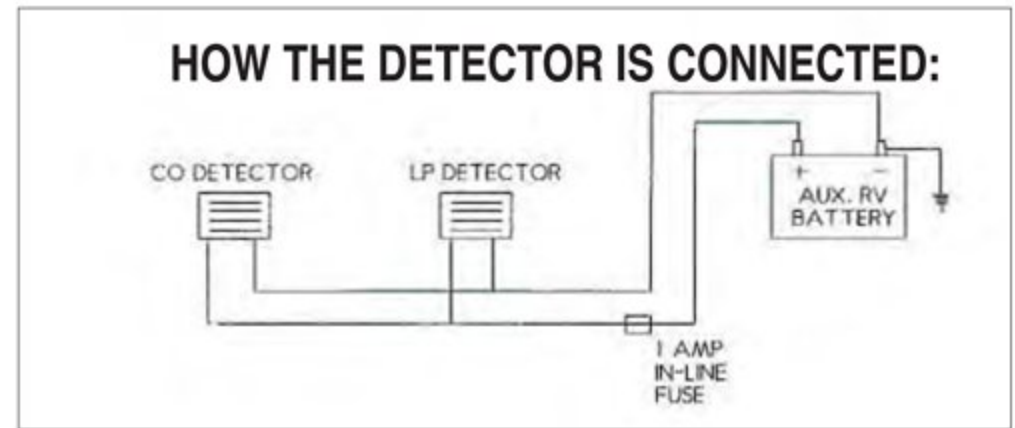

- Hair spray triggers the detector:** Most aerosol hair sprays use butane gas as the propellant. Butane, like LP Gas, is heavier than air and will settle to the floor level where it will be detected. The detector is doing its job as butane is combustible.
- Other Gases:** Other gases which can cause the detector to respond with an alert include the vapors from any fuel, liquor, alcohol, deodorants, colognes, perfumes, wine, adhesives, lacquer, and most cleaning agents.
- Slow beep rate:** This could be the failure alarm and will occur if the battery is low or in the event that the circuitry fails. It is a continuous series of short beep tones between long intervals and is distinctively different from the alert sound.

After reviewing the above, if the problem still exists, call CCI for assistance.

**NOTE:** The Pre-Tell 1 enters a cleaning and initializing mode every time it is powered. If turned off for less than 15 minutes, the Pre-Tell 1 may produce several short “chirps” within the first 80 seconds of operation. This is normal.

## SERVICE

See your RV Dealer or a qualified LP Gas Service Center should service be required. If they are not familiar with this product, have them call CCI for assistance. If service is not available in your area, call CCI.

## LP GAS SAFETY PRECAUTIONS

### **WARNING**

**DO NOT** store LP gas containers inside the recreation vehicle. LP gas containers are equipped with safety devices which relieve excessive pressure by discharging gas to the atmosphere.

#### **IF YOU SMELL GAS:**

- Extinguish any open flames, pilot lights and all smoking materials.
- DO NOT touch any electrical switches.
- Shut off the gas supply at the tank valve(s) or gas supply connection.
- Open all doors and other ventilating openings. (DO NOT USE THE RANGE HOOD).



5. Leave the area until the odor clears.
6. Have the system checked and leakage source corrected before using again.

Be careful when doing any work or maintenance in the recreation vehicle, that you do not puncture a gas line with a nail, screw, or drill bit.

A complete listing of the LP gas warning labels and decals used throughout the recreation vehicle can be found in the Introduction section of this manual. They are located in the recreation vehicle in locations where the potential for a dangerous situation is present. They have been installed not only because of the requirement to do so, but also as a constant reminder to occupants of the recreation vehicle to exercise proper caution when using or being around LP gas appliances and equipment. Make sure that you and your family understand and follow all of them. Never remove these warning labels and decals. If one should be lost, it should be replaced as soon as possible.

# ELECTRICAL SYSTEM

## **GENERAL INFORMATION**

The electrical power supply provided for the recreation vehicle is a dual system, operating with 120 volt AC and/or 12 volt DC.

The 120 volt power may be provided by either connecting the recreation vehicle to an outside power source when parked, or by use of a recreation vehicle generator. When the 120 volt system is operational, power also passes through a system converter, allowing the full use of all 12 volt functions in the recreation vehicle.

120 volt functions in the recreation vehicle include the refrigerator, ice maker, roof mounted air conditioner(s), TV and VCR, microwave oven, converter, outlets for 120 volt operated conveniences, and possibly some lights. The refrigerator also has the option of running on LP gas when 120 volt power is not available. All other electrical functions in the motorhome are supplied with 12 volt power. When it is not possible to access 120 volt power, the 12 volt system functions can be supplied by the auxiliary batteries. The chassis battery is protected by a battery isolator controller to prevent discharge from excessive electrical consumption when the motorhome is not running.

The auxiliary batteries are recharged by the power converter when the recreation vehicle is attached to an outside 120 volt power source, or by the generator when it is running, and by the chassis alternator when the chassis engine is running.

## **CONNECTING TO AN OUTSIDE POWER SOURCE**

### **30 AMP SHORE POWER**

#### **DANGER**

Connecting the shore cord to a non-grounded or improperly grounded power source can result in dangerous and possibly fatal electric shock. Due to the potential danger in failing to heed this warning, the motorhome manufacturer cannot be responsible should damage, injury, or death result from failure to connect the power cord to a properly grounded power source.

#### **WARNING**

If shore power service is limited to 15 or 10 amps, use of light duty extension cords and electrical adapters will create a Voltage loss through the cord and at each electrical connection. Line Voltage loss and the resistance at each electrical connection can be a hazardous combination. Damage to sensitive electronic equipment may result.

The motorhome is designed to be connected to a 30 amp service, which provides 120 volts. The motorhome should never be connected to any power source that will provide more than 60 volts on either line coming in. Failure to follow this will result in serious damage to internal items that are plugged in.

A 30 amp shoreline power cord is provided to attach the recreation vehicle to a grounded power source. The electric utility service connection is located on the driver's side of the recreation vehicle near the rear, in various locations depending on the model that you have. The power cord is stored inside the electric utility service compartment. The electric utility service door has a slot with a cover that can be moved to the side, allowing the power cord to be used and the door to be closed and locked for security.

If 30 amp service is not available, connect the proper electrical adapters to the shore cord. Only UL approved adapters are to be used. The most common adapter is a 50-30 amp adapter.

Always connect the adapter to the shore cord prior to making the connection to the outlet. Never use a two-wire extension cord, a cheater adapter with the ground pin removed, or install a lower amperage plug on the power cord in place of the molded plug.

When connecting or disconnecting from a grounded external power source, always turn off the shore power breaker to the power supply outlet. This will prevent accidental shock and flashing of electrical contacts. After connecting the motorhome to the grounded external power source, wait a few minutes for the inverter/charger to stabilize charging of the batteries before starting large AC loads such as the air conditioners.

## **WARNING**

**Connection to inadequate power source or improper use of adapter cords may result in fire or property damage. Always consult a qualified electrician prior to use or operation of adapter cords.**

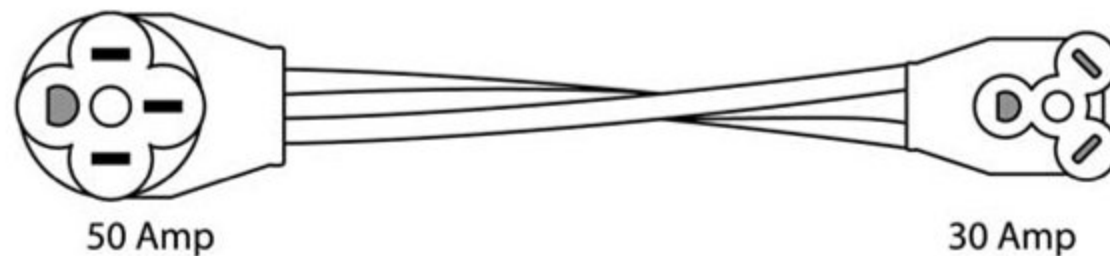

## **50 AMP SHORE POWER**

## **WARNING**

**The motorhome is designed to be connected to a 50 amp service which provides a combined total of 240 Volts. The 240 Volts comes from two separate 120 Volt lines that are in the shore power cord. The motorhome should never be connected to any power source that will provide anything more than 120 Volts on either line coming in. Failure to follow this will result in serious damage to internal items that are plugged in.**

A 50 amp shoreline power cord is provided to connect the motorhome to a grounded external power source.

If 50 amp service is not available, connect the proper electrical adapters to the shore cord.

Only UL approved adapters are to be used. The most common adapter is a 50-30 amp adapter. Another common adapter is a 30-15 Amp adapter. This type of connector adapts the 30 Amp shore cord to a 20 Amp shore power outlet.

**NOTE:** Shown below are the three types of shore power outlets which are most commonly used throughout the United States.

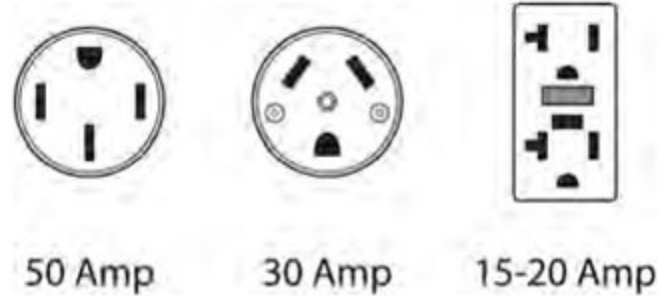

## **BATTERIES**

The chassis and/or auxiliary batteries of a motorhome may be located behind the front hood of the motorhome or in an exterior compartment. This battery is mounted in a battery box with removable lid. To access the battery, remove the screws and lift the top case off. When reinstalling the cover make sure all connections are tight and the lid seals completely when secured to prevent battery fumes into interior of the coach.

It is important to make sure that batteries are kept charged. Take time to turn off all lights or other 12 volt conveniences when not in use. Connect the recreation vehicle to a 120 volt power supply when possible, instead of draining the batteries. The charge condition of the batteries can be checked with the monitor panel. To check, press and hold monitor test switch while reading the charge level on the battery gauge. Charge levels indicated are divided into sections from weak through fully charged.

## **BATTERY SAFETY**

### **DANGER**

**BATTERIES CAN EXPLODE!** Always wear splash proof safety glasses when working near batteries. Do not smoke or expose any battery to electric sparks or flame. Batteries, when charging or discharging, generate hydrogen. Hydrogen and air is a very explosive mixture.

### **WARNING**

**Do not short across the battery terminals. The spark could ignite the gases. Do not wear metal jewelry or a watch when working on a battery.**

**Before doing ANY work on electrical system, disconnect battery cable and the 120 volt power cord. Do not reconnect the cables until all work has been completed. This will avoid the possibility of shorting or causing damage to electrical components or shock to the servicing person.**

**Battery electrolyte is a corrosive, poisonous, sulfuric acid. Avoid contact with skin, eyes, clothing, or any painted surface.**

## **BATTERY MAINTENANCE**



### **DANGER**

**WARNING:** Sulfuric acid in the batteries can cause severe injury or death. Sulfuric acid can cause permanent damage to eyes, burn skin and eat holes in clothing. Always wear splash-proof safety goggles and gloves when working around the battery. If battery electrolyte solution is splashed in the eyes, or on the skin, immediately flush with clean water for 15 minutes. In case of eye contact, seek immediate medical treatment. Never add acid to a battery once the battery has been placed in service. Doing so may result in hazardous splattering of electrolyte solution. Battery maintenance is important. Checking the condition of a battery at regular intervals will help insure its proper operation. Here are some recommendations for checking and servicing batteries,

1. Keep the battery mounted securely. Vibration causes early failure of many batteries.
2. Check the electrolyte level of the auxiliary batteries at regular intervals. Keep each cell filled to just above the plates with distilled water. Once the plates have dried out, they cannot be reactivated, and the capacity of the battery is reduced in direct proportion to the area of plate surface that has become dry. This kind of damage can occur quickly; usually it can happen overnight. If the fluid level is low, simply add distilled water. **NOTE: These instructions only apply to batteries other than maintenance-free batteries. Do not open or break seals on maintenance-free batteries.**
  - While holding a clean hydrometer vertically and wearing splash-proof safety glasses, squeeze the rubber bulb, insert the nozzle into the electrolyte in the cell, and release the bulb. The electrolyte will be sucked up into the barrel or container allowing the float to ride freely. Start with the cell that is closest to the POSITIVE (+) terminal.
  - Squeeze the rubber bulb to release the electrolyte back into the battery's cell.
  - To increase the accuracy of the measurement, in the same cell, repeat this process several times so the float will reach the same temperature as the electrolyte. If you are measuring a large battery, stratification can occur when the more concentrated electrolyte settles to the bottom. If you notice a difference in the readings between the top and bottom of the cell, average the two readings.
  - At eye level and with the float steady, read the specific gravity at the point the surface of the electrolyte crosses the float markings. The specific gravity reading should be between 1.100 and 1.300.
  - Release the electrolyte back into the cell from which it was taken and record the reading. Be sure to avoid spillage.
  - The hydrometer is calibrated at 80° F. Temperature affects the hydrometer reading. The higher the electrolyte temperature, the higher the specific gravity reading. The lower the temperature, the lower the specific gravity reading. Add or subtract four (4) points for each 10° variance from the 80° F chart. Readings between cells should not vary more than 50 "points" (0.50).

- Repeat the process for each individual cell. The specific gravity reading should not have a difference of more than 30 “points” (.030) between the lowest and highest reading or 10 “points” (.010) below the battery manufacturer’s recommended temperature value with the battery fully charged. If so, try and equalize the battery by following the battery manufacturer’s procedures. If equalizing does not help, replace the battery. You can determine the battery’s state-of-charge by taking the average of the temperature compensated cell readings.
  - Thoroughly rinse the hydrometer with water after using it.
3. Keep the battery clean. Corroded terminals make poor contact and do not allow the chassis alternator or the converter to bring the battery up to full charge. Battery sulfation occurs when the battery has been standing in a discharged condition over a long period of time, or when the battery has been operated continually in a state of partial discharge. Use a baking soda solution to neutralize the acid accumulations on the battery top. Do not allow the soda solution to enter the battery. Make sure the vent caps are secure. Flush with water. Thoroughly dry all cables and terminals, reinstall, and use a plastic ignition spray to protect the terminals.
  4. Check the outside condition of the battery. Look for cracks in the case or vent plugs. If the case is cracked, the battery must be replaced. If the vent plugs are cracked, they must be replaced.
  5. Watch for overcharging. Three ways to spot overcharging are:
    - Active material on the vent cap (heavy deposit of black lead-like material on the underside of the vent cap).
    - Excessive use of water.
    - By testing voltage regulator output.
  6. Make sure the battery hold downs and carrier are kept clean and free of corrosion.

When removing a battery, disconnect the ground battery clamp first. When installing a battery, always connect the grounded battery clamp last.

When a battery needs to be replaced, make sure to replace it with a battery of the same characteristics as the original equipment. Consult your dealer for advice on battery replacement.

### ***AUTOMOTIVE 12 VOLT SYSTEM***

Your motorhome chassis is equipped with an automotive 12 volt fuse panel located below the dash near the steering column. You should refer to the chassis owner’s manual for details on these fuses.

The Class A motorhome also has a 12 volt fuse panel, electrical distribution box, located on the firewall under the hood. These fuses protect the automotive features which are installed by **Four Winds International**. There is a complete breakdown on the various fuses printed on the backside of this fuse panel cover.

## **BATTERY ISOLATOR CONTROLLER**

### **(Class A Motorhomes, Some Models)**

When the motorhome engine is not running, the chassis and auxiliary batteries are kept separated from each other within the electrical system through the use of a battery isolating controller. The controller prevents the auxiliary batteries from discharging the chassis battery when the motorhome is parked.

### **Some additional characteristics of the isolator system include:**

1. Delays connecting the auxiliary batteries to the charging system for approximately 15 seconds, to allow the alternator time to reach full charging ability.
2. After this initial time delay, if the alternator has come up to full charging ability, the isolator will electrically connect the auxiliary and chassis batteries together for charging.
3. If the charging voltage drops below 12 volts for a period of 4 seconds due to low idle speed and/or excessive load, the isolator will disconnect the auxiliary batteries until the voltage returns to a level of 13.3 volts for about 10 seconds.
4. If the auxiliary batteries are above 11.5 volts and the chassis battery is below 9 volts, the isolator will automatically provide an emergency start from the auxiliary batteries.
5. In the event the automotive battery is fully discharged, the automatic emergency start feature will not function, it will be necessary to press and hold the start button located on the control box inside the 12 volt electrical distribution box under the hood or on the dash on some models.

## **BATTERY ISOLATOR**

### **(Class C Mini Motorhomes)**

When the motorhome engine is not running, the chassis and auxiliary batteries are kept separated from each other within the electrical system through the use of a battery isolator solenoid. The isolator solenoid prevents the auxiliary from discharging the chassis battery when the motorhome is parked.

If power is lost to the interior from the auxiliary battery, check the breaker mounted on the side of the isolator solenoid under the hood.

**NOTE:** When operating 12V equipment from battery, reduce equipment in use to conserve battery. Gradual dimming of lights, and slowing of motors indicates low battery voltage.

## **RS400 INVERTER**

The RS400 inverter in the coach has been installed to provide 120 volts to your TV and entertainment system and power garage door options if equipped. The inverter will take 12 volts from your coach battery and convert it into 120 volts. The inverter is controlled by a remote switch that is located near your coach disconnect switch near the entry door. In order for the switch to work properly, the ON/STANDBY switch on the inverter must be in the On position. STANDBY is used when the unit will not be needed for any length of time. This will ensure that the unit will not draw any unnecessary voltage from the battery. ON is therefore used when you need to have 120 volts and you are not connected to shore power and you are not able to use the generator.



The front panel on the inverter has a few features that you should be aware of in case troubleshooting is needed.

1. **ON/STANDBY** switch is used to turn the inverter ON or to STANDBY. This is the switch that needs to be ON for the remote switch to work.
2. **AC Input light** illuminates when you are connected to shore power. (This could be from a utility grid, generator, or other external AC source.)
3. **Inverter ON light** illuminates only when the RS400 is operating in invert mode.
4. **Low Battery light** illuminates when your battery voltage is lower than 10.7 volts.
5. **Fault light illuminates** for fault conditions such as over temperature, output overload, or battery over voltage.
6. **Supplemental Circuit Protection button** trips if there is an overcurrent (over 7.5 amps) or a short circuit.
7. **GFCI** opening enables Reset and Test monthly capability.
8. **Ventilation openings** provide air circulation for peak performance.

For additional information on these items, please refer to your RS400 owners manual.

## **POWER CONVERTER**

The converter is used to switch 120V electricity from an external supply, or from the generator, to 12V electricity to power interior lights and 12V accessories. The converter requires no maintenance under normal circumstances.

If the converter does not have a 120V supply to convert to 12V, it automatically switches the batteries into the electrical circuit to power 12V functions. When reconnected to a 120V supply, it will again operate from this power source.

The converter will run warm and this is normal. If, however, it gets too hot, it will turn itself off. After it cools down, it will come back on. In most cases, when this happens it is because something has



been put around or too near the converter preventing it from receiving adequate ventilation. Make sure not to put anything near the converter that could obstruct ventilation.

A slight hum during operation is also normal for the converter, if you do not have 12 volt power and no hum, check to see if 120 volt power to the converter has been interrupted.

## **BATTERY CHARGING**

### **WARNING**

**Always wear splash proof safety glasses when working with batteries.**

The converter also operates as a battery charger when it is connected to a 120V power source. If the battery is below its full charge, the converter charger will begin operation at a rate that reflects the level of discharge. When the battery is again fully charged, the converter charger drops its charging level back to a maintenance level to keep the battery fully charged.

If for any reason you charge a battery with a source outside the recreation vehicle, make sure to follow the rules of battery maintenance and safety outlined in this section. Also observe these additional safety precautions related to battery charging;

1. Disconnect the battery from the recreation vehicle.
2. Check electrolyte before charging. Be sure each cell is properly filled with distilled water.
3. Make sure to use care when connecting and disconnecting the cables from chargers. A poor connection can cause an electrical arc, which can result in an explosion.
4. Remove the battery vent caps before charging, and make sure that the electrolyte does not splash out as a result of charging too quickly.
5. Check literature supplied by battery manufacturer, and follow warnings or cautions outlined.

## **BATTERY DISCONNECT SWITCH**

The battery disconnect switch allows you to easily disconnect the auxiliary batteries from electrical circuits, preventing unwanted discharge during extended nonuse. The switch(s) is/are mounted on a panel near the entrance door.

**There are three main uses of the battery disconnect:**

1. Prevent unwanted discharging of batteries during extended periods of storage.
2. Prevent shorts or fire hazard while working on the 12 volt electrical system.
3. Prevent overcharging of batteries if the motorhome is attached to shoreline power for extended periods.

When activating, place the switch for the desired battery system in the ON position. This battery system will now be operational. The disconnect switch must be in the ON position while plugged into shoreline power to charge the battery(s). Place the switch in the OFF position to disconnect 12 volt circuits.

**NOTE:** *It is not necessary or advisable to use battery disconnect switches as a substitute for turning off the various 12 volt applications available in the motorhome.*

**NOTE:** *If 12 volt functions are not working, be sure to check that the battery disconnect switch has been placed in the ON position.*

## **GROUND FAULT CIRCUIT INTERRUPTER**

### **WARNING**

**WARNING:** Even with GFCI protection, persons with severe heart or other health problems may still be seriously affected by an electrical shock. The GFCI outlet is not a substitute for good electrical safety. It DOES NOT protect against contact of the hot and neutral wire at the same time.

The 120 volt outlet in the kitchen and/or bath is equipped with a protective circuit interrupter. The ground fault circuit interrupter (GFCI), is designed to break the flow of current to the protected outlet when an imbalance of current is detected. Imbalances include electrical leakage in an appliance such as a shaver or hair dryer that have developed a weak spot in electrical insulation. The possibility of electrocution exists when using a faulty appliance, while at the same time being in contact with an electrical ground such as water, plumbing, or the earth.

If an imbalance is detected, the GFCI will trip and shut off power to the outlet. Even with GFCI protection, the electrical shock will still be felt, but to a lesser degree.

It also does not protect against short circuits or system overloads. Circuit breakers in the main panel which supply power to the circuit, will trip if either of these conditions exist.

The GFCI receptacle should be tested initially when the recreation vehicle is purchased, and at least monthly thereafter.

#### **To test the circuit, use the following procedure:**

1. Make sure power is on to the circuit. A test light or 120-volt lamp will work.
2. Push the test button.
3. The red reset button should pop out.
4. All power should be interrupted to outlets protected by the GFCI.
5. Verify by plugging in a light at these outlets, and pushing in the reset button.

If the red reset button does not pop out after pushing the test button, or GFCI circuit continues to trip, or if the power is not interrupted to the test light, immediately turn off power at the circuit breaker panel and have a qualified electrician check it out.

**NOTE:** *The GFCI does not protect any circuit other than the one to which it is connected.*

## **CIRCUIT BREAKERS**

The 120 volt system is protected by circuit breakers which automatically shut the circuit off if the circuit load is too heavy, or a short circuit occurs. If a circuit breaker has been tripped, do not reset the breaker until the cause of the problem is identified and corrected.

The generator also has one or two AC circuit breakers, and a DC fuse on the generator control panel. If an interruption in generator operations occurs, check to see if any of these have been tripped. Consult the manuals provided with the generator before attempting maintenance on the generator.

**NOTE:** *Some electrical appliances may have their own circuit breakers. If there is an interruption in electrical service of an appliance, consult the manual for that appliance to determine what action to take.*

## **12 VOLT FUSES**

### **INTERIOR 12 VOLT SYSTEM**

A 12V DC distribution panel is located next to the 120V circuit breakers. The panel contains circuits with replaceable fuses for protection of recreation vehicle 12V lines. If any line is loaded beyond the capacity of its fuse, the fuse will "blow". A portion of the 12V load on the line must be turned off to reduce the total load on the line to a level below the capacity of the fuse. Replace the fuse with the same size fuse. DO NOT replace with a larger fuse than indicated.

If this reduction of load on the line does not stop the "blowing" of the replaceable fuses, there may be a "short" somewhere along the 12V line, or at a non-fused 12V component on the line. Check the 12V line and any components along the line. Locate the "short" and take necessary steps to repair it. If you cannot locate the problem, have a qualified electrician check it out.

It is a good idea to keep additional fuses on hand in the recreation vehicle. Replacement fuses are available at filling stations, hardware stores, or automotive supply stores. Remember that the replacement fuse must be the same amperage rating as the original.

### **AUTOMOTIVE 12 VOLT SYSTEM**

The primary point to keep in mind about the unit's 12-volt system is that the automotive chassis alternator supplies power to both the automotive systems as well as any auxiliary battery and directly to the RV living quarters while the vehicle's motor is running.

Thus, of primary concern to you is the condition of the vehicle's electrical system and especially the alternator.

The alternator compensates for electrical usage in the vehicle ... the power drawn by the appliances, lights, fans and other 12-volt powered items as well as the charging of the automotive and auxiliary batteries.

If the alternator isn't keeping pace with the draw on the unit's electrical system, while driving down the road, it means you're working in a negative mode: more power is being used than the unit is putting out.

This means that you are taking power out of the batteries. If you draw too much power from the batteries there may not be enough power left in the battery to start the RV or run any of the appliances when you stop for a break or for the night.

So, always keep an eagle eye on the alternator's output. Also check the monitor panel frequently to see that the auxiliary battery is up to full charge.

The alternator will charge at a higher rate right after the vehicle's been started, replacing the power used to start the vehicle, but the charging should quickly go back to "normal" and hold its own even when you turn on lights or appliances.

When stopped at a campsite that allows you use of the shoreline, the 120-volt electrical system will recharge your auxiliary battery.

Some monitor panels will show a battery as being fully charged unless there is a draw on its system.

When checking auxiliary battery condition, turn on several interior lights to place a load on the battery. Under heavy usage in warm weather, check the fluid level of those batteries that require attention to fluids quite often. Low battery fluid level is very harmful to the battery's longevity.

If the alternator shows a discharge while the motor is running, turn off appliances and lights to see if a charge comes on or if the alternator indicates "neutral". Then apply a drain on the system to see if a discharge returns. If a discharge persists, contact your dealer.

Sometimes, especially in hot weather, the alternator may show a marginal condition while idling with the air conditioner in use. Note if the system goes more to normal while the vehicle is at speed. If the marginal condition continues and you are in a constant stop-and-go traffic situation, such as in a populated area, it may be a benefit to turn off the air conditioner.

## **GENERATOR**

***NOTE: MAKE SURE TO READ AND UNDERSTAND THE GENERATOR OWNER'S MANUAL BEFORE OPERATING THE GENERATOR. Observe all warnings and cautions, as well as all recommended maintenance schedules and procedures.***

To utilize the generator, it is necessary on some models to plug the shoreline 30 amp plug into the outlet provided in the shoreline storage compartment. When outside 120 volt service is available, simply unplug the shoreline from this outlet and plug it into the exterior outlet as outlined earlier. On some models when the generator is accessed, electrical connection is automatically switched over to the generator through a transfer switch.

**For Gasoline Engines:** The generator is fueled from the same tank which supplies fuel for the chassis engine. The tube which supplies the fuel for the generator is placed higher in the tank than the chassis engine fuel supply tube. This prevents the generator from draining all fuel from the tank. On diesel powered motorhomes, the generator may be fueled by LP gas from the LP gas tank.

There may be three locations from which to start the generator. One is at the control panel on the generator itself, while the other is located on the kitchen sink base inside the recreation vehicle. Some models also have a remote switch on the dash.

## **GENERATOR SAFETY**

There are several warnings and precautions that should be observed when using the generator. **MAKE SURE** to read all warnings and cautions in the generator operator's manual before operating or attempting repairs on the generator.

1. Never store anything in generator compartment. Always keep compartment clean and dry.
2. Review the safety precautions for fuel and exhaust fumes elsewhere in this manual.
3. **DO NOT** operate the generator while sleeping. You would not be aware of exhaust entering the recreation vehicle, or alert to symptoms of carbon monoxide poisoning.
4. **DO NOT** operate the generator when the recreation vehicle is parked in high grass or brush. Heat from the exhaust could cause a fire in dry conditions.
5. Never operate your chassis or generator engine, or the engine of any vehicle, longer than necessary when the vehicle is parked.
6. **DO NOT** simultaneously operate generator and a ventilator which could result in the entry of exhaust gas. When exhaust ventilators are used, we recommend that a window on the opposite side of the unit "upwind" of exhaust gases be opened to provide cross ventilation.
7. When parked, orient the vehicle so that the wind will carry the exhaust away from the vehicle. **DO NOT** open nearby windows, ventilators, or doors into the passenger compartment, particularly those which can be "down wind", even part of the time.
8. **DO NOT** operate the generator when parked, so that vegetation, snow, buildings, vehicles, or any other object could deflect the exhaust under or into the vehicle.
9. **DO NOT** touch the generator when running, or immediately after shutting off. Heat from the generator can cause burns. Allow the generator to cool before attempting maintenance or service.

# WATER & DRAINAGE

## **GENERAL INFORMATION**

Your new recreation vehicle plumbing system has the dual ability to be self-contained with onboard storage, or use facilities provided by an external pressurized source. In either case, the components of the system operate like those in your home. Components of the plumbing system consist of strong, lightweight, corrosion-resistant materials that provide long life, and easy cleaning. By following the instructions outlined here, you can expect efficient operation with a minimum of maintenance.

Recreation vehicle plumbing can be divided into two separate systems. The fresh water system consists of those items which are used to deliver water for your use, while the waste water system is made up of the drains and tanks which store and remove water that has been used.

## **FRESH WATER SYSTEM**

Fresh water is provided from an external pressurized source, or from the fresh water storage tank.

### **EXTERNAL HOOKUP**

Water provided from outside the recreation vehicle is pressurized by the system from which it is delivered. When you connect your recreation vehicle to an outside source, the fresh water tank and the water pump are kept separate from the remainder of the system by in-line check valves.

#### **To attach the recreation vehicle to an outside source of water:**

1. Remove the cap from the fresh water inlet on the side of the recreation vehicle.
2. Attach one end of the fresh water hose to the outside source of water.
3. Connect the other end of the hose to the recreation vehicle city water inlet.
4. Turn the outside source of water on. Open the various faucets in the recreation vehicle gradually to clear the air from the lines. Close the faucets when the water flows freely.

**NOTE:** *Do not turn the water pump on when using water from an external supply.*

#### **To disconnect from the outside source of supply:**

1. Shut off the outside source of supply.
2. Disconnect the hose from the supply valve and the recreation vehicle inlet.
3. Re-reel the hose and store.
4. Reinstall the cap on the recreation vehicle inlet.

#### **FRESH WATER TANK WITH GRAVITY FILL (If so equipped)**

When an outside source of water is unavailable, water can be drawn from the fresh water storage tank for use in the recreation vehicle. The tank is filled through a gravity controlled water fill spout on the side of the recreation vehicle.

**To fill the fresh water tank, proceed as follows:**

1. Remove the water fill spout cap.
2. Water can now be added directly to the tank through the fill spout by use of a known clean hose or bucket, used only for this purpose.
3. When the tank is filled, replace the water fill spout cap.

**NOTE:** Always fill the tank with clean drinkable water from a known safe source. Make sure to close the fill spout when the tank is filled. Also, always fill the system with a hose that you know is clean, and is used only for this purpose.

When traveling, you may want to drain the tank, or keep the quantity of water in it to a minimum. This reduces the total weight of the recreation vehicle for travel. Make sure when draining the tank, that the water pump has been turned off. The fresh water tank drain valve is located below and near the fresh water fill spout. Water in the tank can be drained by turning the drain cock perpendicular to the recreation vehicle body. To close the valve, turn the lever parallel to the recreation vehicle body.

**NOTE:** When trying to drain entire onboard fresh water system, make sure to open faucets, water heater drain, and system low point drains to remove all fresh water from the system.

**FRESH WATER TANK WITHOUT GRAVITY FILL**

When an outside source of water is unavailable, water can be drawn from the fresh water storage tank for use in the RV. To fill fresh water tank proceed as follows.

1. Attach a potable water hose to the inlet inside the rally kit area, and an outside water supply.
2. Turn the lever on the bypass valve to the fresh tank position.
3. Begin filling the fresh water tank.
4. When the tank is full, turn off the water supply. View reading on monitor panel.

**CAUTION**

**Never leave the hose unattended while you are filling the fresh water tank.**

**WATER PUMP**

When using water from the fresh water tank, the system must be pressurized. A self-priming 12V DC pump is provided to handle this function. A pump on-off switch is located on the monitor panel. The water pump is located next to the fresh water tank.

To access the water pump on Class A models, which have the water tank located between the rear wall and an above/below floor rear storage compartment, it will be necessary to remove the round access plate inside the rear compartment box on the driver's side of the motorhome. Insert a large flat tipped screw driver in the recessed area of the round cover and with a twisting motion the cover should snap open.

**When initially starting up the self contained water system, follow this procedure:**

1. Make sure the tank is filled with water.

2. Open all the faucets in the recreation vehicle, both hot and cold.
3. Place the pump control switch in the ON position.
4. Allow time for the hot water tank to fill. Shut off each faucet as the flow becomes steady and free of air. When the last faucet is shut off, the pump should also shut off.
5. The system is now ready for use.

**NOTE:** When filling the system, you may want to add additional water to the tank to replace the water used when filling the hot water tank and water lines.

The self contained water system is a demand system. This means that the water pump will run whenever there is a need for water. If the pump runs while all faucets are closed, there may be a leak in the system. Ask your dealer for assistance.

**NOTE:** The low point drains are located in the water lines on the floor of the motorhome except the Windsport and Magellen brand motorhomes. Specific locations along the water lines will vary depending on the model of your motorhome. The low point drains for the Magellen and Windsport models is the outside shower which is located in an exterior compartment, below the floor.

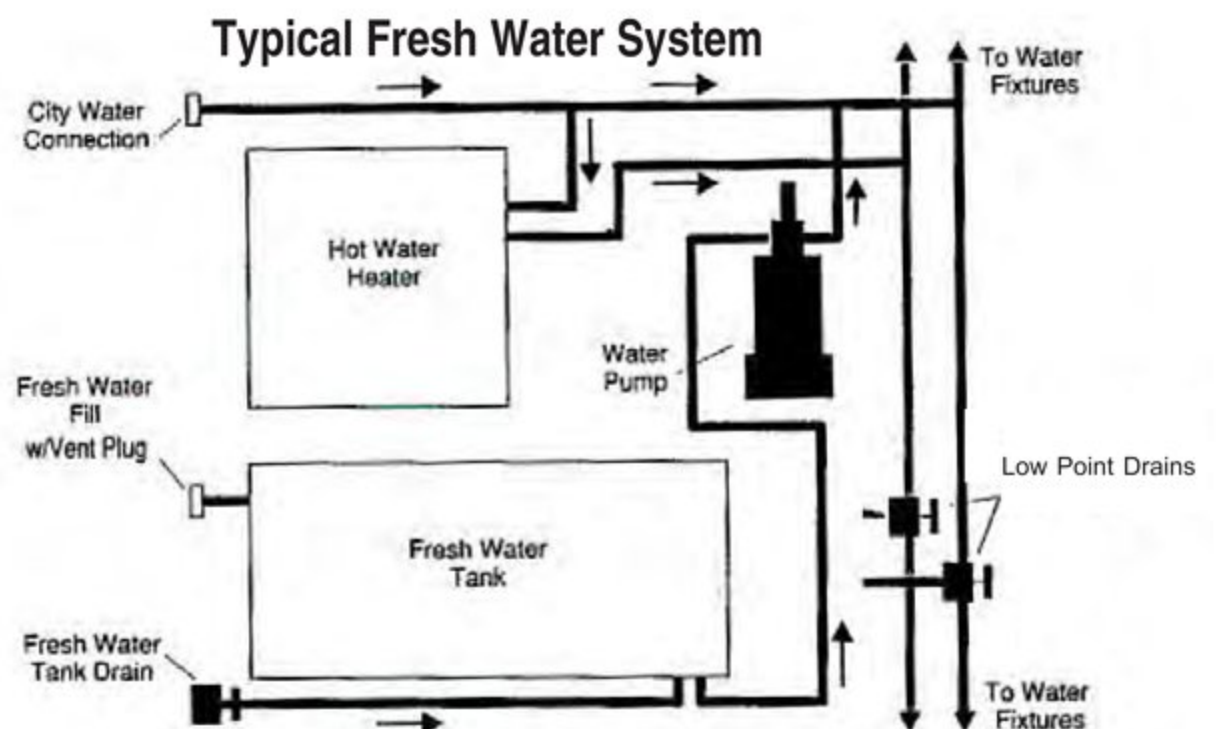

## **SANITIZING THE FRESH WATER SYSTEM**

Sanitize the system before initial use, after extended periods of nonuse, at least once a year during continuous use, and whenever there is suspicion that the system has been contaminated.

**To sanitize the system with a gravity fill, use the following procedure:**

1. Prepare a chlorine solution using a gallon of water and  $\frac{1}{4}$  cup of liquid household bleach (5% sodium hypochlorinate solution). Use one gallon of solution for each 15 gallons of tank capacity.
2. With tank empty, and all faucets and drains closed, pour the solution into fresh water tank.
3. Complete filling the tank with fresh water.
4. Switch on the water pump. Open all faucets one at a time until all air is purged, and the water flows freely.
5. Again add fresh water to the tank until the water level reaches the fill spout.
6. Allow the system to stand undisturbed for a few hours (at least three).



7. Drain the system by opening all faucets, and the fresh water tank drain valve, while flushing the system with water of drinking quality.
8. Continue flushing the system, allowing the water to flow for several minutes.
9. Close the tank drain valve and faucets. Refill the system with water of known drinking quality.

**NOTE:** *A slight chlorine taste may linger. If this is objectionable, mix a solution of 1 quart Vinegar to 5 gallons of water and add to the tank. Let stand for 3 hours and flush.*

**To sanitize the system without a gravity fill, use the following procedure:**

Items needed:

- 1 - Battery powered drill (**do not use an electric drill**)
  - 1 - Drill powered water pump
  - 1 - 5 gallon bucket to prepare solution
  - 2 - 4 foot sections of ½ inch inside diameter hose
  - 2 - Female hose ends for ½ inch hose with ¾ inch threaded end (compression style)
  - 1 - Male hose end for ½ inch hose with ¾ inch threaded end (compression style)
  - 1 - 1 cup of household bleach
1. Install one male and one female hose end to one of the 4 foot sections of hose. When completed, the section of hose will have a male hose end on one side and a female hose end on the other side.
  2. Connect this hose to the outlet side (usually marked with an arrow) of the pump. The other end of the hose will get connected to the city water fill on the coach. Prior to attaching the hose to the city water fill, remove the pressure regulator first, otherwise the pump will not be able to push the water past the regulator. The hose will attach to where the regulator use to be.
  3. Install one female hose end to the other 4 foot section of hose.
  4. Connect this hose to the inlet side of the pump. The end of the hose that does not have hose end will go into the five gallon bucket to pump out the sanitizing solution.
  5. Fill the bucket half full with water and add one cup of household bleach. Attach **battery drill** to the pump making sure that the drill rotation matches the rotation needed to work the pump.
  6. Using the drill, pump the solution from the bucket into the fresh water tank until solution is gone. Remove the pump/drill apparatus and complete filling the tank with water.
  7. Switch on the water pump. Open all faucets one at a time until all air is purged, and the water flows freely. Once the tank is half empty turn off the water pump.
  8. Again, add water to the tank until it is full. Allow the system to stand undisturbed for at least 15 minutes.

9. Turn the water pump on to drain the system by opening all faucets, and the fresh water tank drain valve, while flushing the system with potable water.
10. Continue flushing the system, allowing the water to flow for several minutes, and then turn off the water pump. Close the tank valve and faucets. Refill the system with potable water.

**Note:** *If you would rather not do the above, having your dealer perform this operation would be another option you could choose.*

## **MONITOR PANEL**

The monitor panel allows you to quickly check the levels in the fresh water and waste water tanks. Electrical sensors at various points on the tanks send signals to the monitor panel. To check fluid levels, press and hold the test switch designated for the tanks, and read the level indicators on the panel. The indicator is proportioned in quarters with each light being lit up to the level that the tank contains.

Sometimes, residue on the sides of a tank, or water with a low mineral content will give a false reading. Check the levels occasionally when you are sure of a tank's contents to double check the accuracy of the monitor panel.

**NOTE:** *Other monitor panel functions such as checking the battery charge level are discussed elsewhere in this manual (see Index).*

### **Troubleshooting — Monitor Panel**

When troubleshooting a problem with a Ventline conventional monitor system, always remember that there are three basic system components to consider.

1. The monitor panel assembly, which includes the circuit board, lights, and switching.
2. The wiring harness, which includes the wires and connectors which connect the monitor panel to 12 volt DC power, ground, tank sensors, LP sensors and switching.
3. The holding tank sensors, level sensors, and fresh water tank sensors.

In many cases a malfunction of one of the above components will be reflected in another, which can result in misdiagnosis of the actual problem. Ventline recommends a consistent, methodical approach to troubleshooting in order to diagnose and correct the problem with the minimum investment in time and resources.

### **Prior to troubleshooting any monitor panel problem, verify the following:**

1. You are in possession of the correct wiring diagram for the specific system requiring diagnostics.
2. The 12 volt power source is present and originates from the battery or the filtered side of the power converter.
3. The chassis ground is present and has a good connection through the negative side of the battery.
4. The monitor panel assembly has been inspected and is free from damage. Check for broken wires, loose components and connectors.
5. The wiring harness is connected properly and is free from damage.
6. The tank sensor and level sensor wires are connected properly and are free from damage.

7. The tank level sensors are properly located and are free from damage.
8. All wiring is done in accordance with the wiring diagram.
9. All of the above components are accessible during troubleshooting.

After the above is verified, proceed with troubleshooting the system. Refer to the monitor panel troubleshooting guide supplied separately from this owners manual.

### **Common Field Problems**

1. Inaccurate Holding Tank Level Readings
2. Some or All Holding Tank Level Lights Not Coming On
3. Some or All Holding Tank Level Lights Continuously On
4. LP Gas Levels Not Reading Properly

### **Inaccurate Holding Tank Level Readings**

The accuracy of two wire holding tank monitoring systems can be adversely affected by dirty tanks, unusual mineral content in the water, or improper holding tank probe location. These conditions can cause the monitoring system to have oversensitive (reads higher than actual level) or under sensitive (reads lower than actual level) readings.

**Oversensitive readings:** Oversensitive readings can occur as a result of scum buildup on the tank walls, abnormally high mineral content in the water, or incorrectly located holding tank probes. In these situations, the monitoring system indicates higher levels than are actually present in the holding tank. Certain cleaning products and food byproducts can build up on the inside walls of the holding tanks, producing a layer of scum that can cause the monitoring system to read higher than the actual level. To correct this problem, the holding tanks should be cleaned periodically (consult dealer for cleaning instructions). If the problem persists after cleaning the holding tank, the ground probe can be moved farther away from the other tank probes. The increased distance between the ground probe and the other probes will decrease the sensitivity of the monitoring systems.

**Under sensitive readings:** Under sensitive readings can occur if the mineral content of the water is abnormally low or if the holding tank probes are located incorrectly. In this case, the monitoring system indicates lower levels than are actually present in the holding tank. This problem can be corrected by moving the ground probe closer to the other probes. Moving the ground probe closer increases the sensitivity of the monitoring system.

**The Ventline Adjustaboard™:** In response to requests from the field for a means to adjust monitor sensitivity without relocating holding tank probes, Ventline has developed the Ventline Adjustaboard™ (patent pending). This adjustable circuit board allows for field adjustments to monitor sensitivity. As tank conditions or water mineral content changes, the monitor circuitry may be made more or less sensitive as required. Please refer to the Monitor Panel Troubleshooting Guide supplied separately from this Owners Manual.

### **Ventline Technical Support**

If the above information is inadequate to solve your specific troubleshooting requirement on any Ventline Conventional monitor panel system, please contact Ventline for technical support. Ventline technical support staff will require the specific model number of the monitor panel in question (marked on the rear of the monitor panel), as well as the make and model of the recreation vehicle in which the monitor is installed. Please be prepared with this information in advance. Failure to furnish this information will result in unavoidable delays and may prevent us from assisting altogether.

Ventline, Division of Philips Products  
902 South Division PO Box 629  
Bristol, IN 46507

Tel # 574-848-4491 Fax # 574-848-4825

## **WASTE WATER SYSTEM**

The waste water system in your recreation vehicle can be described as two separate systems. A gray water system that consists of the drain lines and holding tank for waste water from the sinks and tub, and a black water system which includes the holding tank and drain for toilet wastes. In some cases the bathroom lavatory may drain into the black tank. Each system is self-contained, and allows disposal of waste water at designated dump stations at your convenience.

Components of the gray water system have drain traps, and both tanks are vented to equalize air pressure and disperse odors caused by drain water and wastes outside. Sometimes, the rocking movement of the recreation vehicle while driving may empty the drain traps of their water, and allow the odors of the gray water tank to come into the coach. Residue in the drain water lines can also produce odors. To combat gray water holding tank odors, an approved deodorizing agent should be used. An agent that dissolves grease and fats and contains a detergent will help keep tank and drain lines clean and free-flowing.

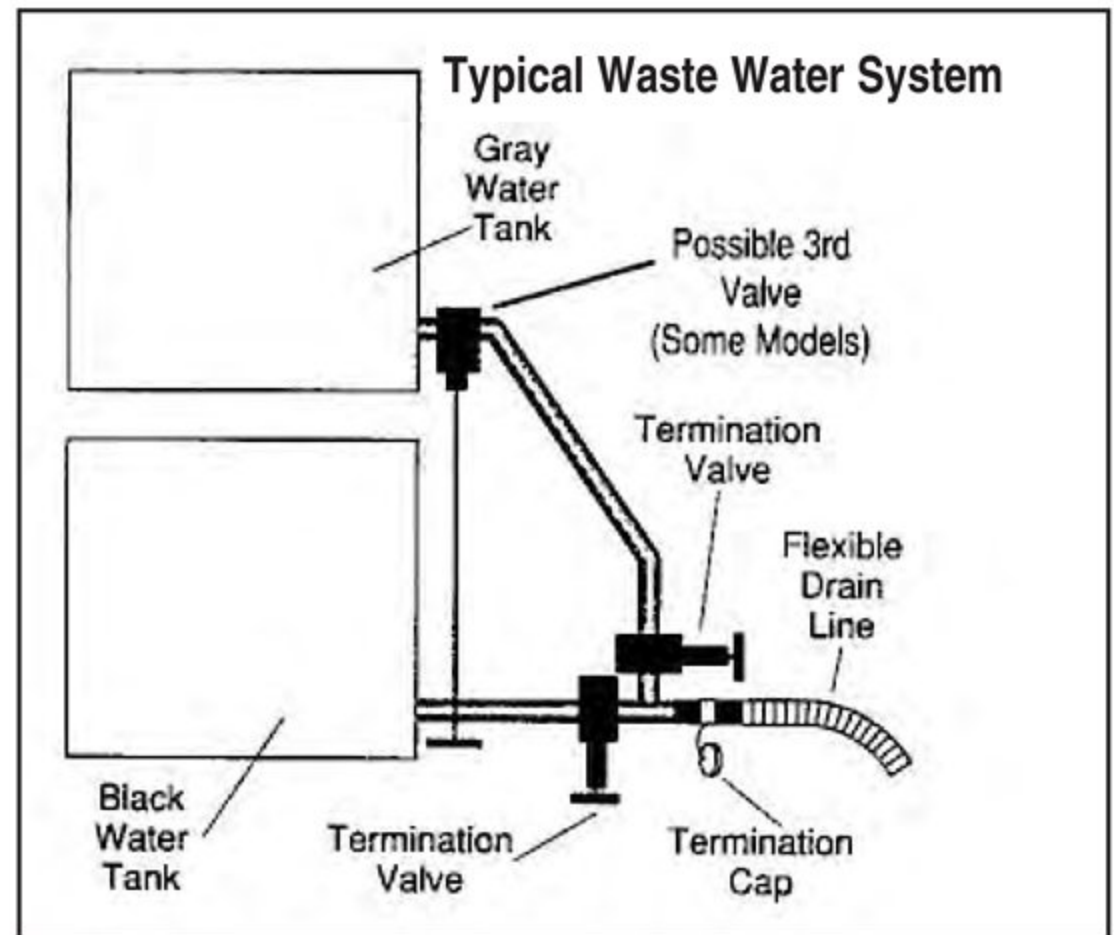

## **HOLDING TANKS**

Both holding tanks are approximately located beneath the bathroom area. Drain valves and drain hose storage are located on the driver's side.

Each tank has a separate drain line and dump valve, which permits dumping tanks individually or together. Each tank should be emptied often at a dump station designated for this purpose. Most national, state, and private campgrounds have dumping facilities. Many have hookups on the campsite, while some have portable dump collectors. Many service stations, particularly along interstate highways, also have these facilities. Many campground directories list dumping station locations across the nation.

If possible, dump holding tanks before a trip, to reduce the gross vehicle weight. Enough water should be kept in the black water tank to cover the bottom, to prevent hardening of any residue that may remain.

Do not dump black water tank until it is 3/4 full. This practice makes sure that enough water is in tank to flush all wastes into sewer lines. If necessary, fill tank to the 3/4 mark with additional water before draining.

Never put anything in the holding tanks other than normal drain water, wastes, and biodegradable products. Paper wrappers, gum, cigarettes, etc., no matter how small they may be, should never be placed into either the gray or black tanks.

**NOTE:** *It is important to note that harmful and toxic materials can accumulate if the holding tanks are not regularly drained and thoroughly rinsed. It is also important to use holding tank deodorizing and cleaning agents in the waste water tanks to reduce odors and keep the lines open and free-flowing.*

### **To Empty the Holding Tanks:**

1. Remove the sewer drain hose from its storage compartment on the side of the coach.
2. Remove the cap from the recreation vehicle sewage drain, and connect the drain hose to it.
3. Attach the other end of the flexible drain line to the dump station inlet. Make sure both ends of the flexible drain line are securely attached.
4. Drain the black water tank first, by pulling the termination valve handle toward you. Make sure to allow sufficient time for the tank to completely drain, then rinse the tank with several gallons of water by depressing the stool pedal. Close the valve on the stool and let it fill before releasing the tank. This creates additional force to flush the tank more completely.
5. Drain the gray water tank by pulling the termination valve handle toward you. Draining the gray water tank last, with its soapy water helps to further rinse the drain and flexible hose,
6. When tanks are emptied, close termination valves by pushing handles back to closed positions.
7. Remove flexible drain hose and wash it thoroughly with clean water. Remove the other end from the dump station inlet, and replace it in its storage compartment. Secure the sewer hose storage cover, and replace the caps on both the recreation vehicle outlet and dump station inlet.

### **The following guidelines will help to ensure trouble free operation:**

1. Never put anything in black water tank other than toilet paper especially for RV systems.
2. Do not put automotive antifreeze, household toilet cleaners or drain cleaners, or any solid material into the waste water system.
3. Always use chemicals in the black water system that are made especially for this purpose.
4. When cleaning components of waste water system, use cleaners made for RV systems.
5. Always keep the drain cap in place, and termination valves closed.
6. After every third time the holding tanks are emptied, fill and flush both tanks with clean fresh water a couple of times to keep them clear and clean.

**NOTE:** *If connecting to a campsite sewer inlet, DO NOT open termination valves until tanks are 3/4 full. DO NOT keep black water valve open while parked. Wastes are NOT flushed directly into sewer system. Only liquid waste is drained, therefore, water must accumulate, and chemicals in tank need time to break down solids before they can be released. If draining gray water tank directly into sewer inlet while parked, make sure to close termination valve for a period of time before leaving, allowing some water to accumulate in tank to use for flushing drain line and flexible hose.*

**NOTE:** Always remember to clean up the dumpsite before leaving. NEVER empty your holding tanks directly on the ground, a roadway, river or stream. DO NOT POLLUTE.

## **FAUCETS**

The faucets in your recreation vehicle have been designed to be economically practical faucets that can be both beautiful and durable. The one-piece plated faucet shield is put through extensive treatments to produce a surface finish which will maintain its lustrous beauty throughout many years of use.

The patented design eliminates washer wear — the common cause of leaking. Should your faucet develop a leak it is most likely caused by debris in the water line causing improper seating of the stem tip; or as a result of the handle stop being misaligned.

Refer to the faucet owner's manual supplied with your recreation vehicle for specific maintenance and service instructions and an 800 phone number for service.

## **TOILET**

The marine style toilet installed in your recreation vehicle is connected to the pressurized fresh water system. The toilet is equipped with two operating levers located on the back right side of the toilet when facing it. To flush, pull the black lever forward (clockwise) until rinse clears the bowl. Be sure to release the lever slowly. Movement of the flush lever opens the waste valve and allows the water to pass into the holding tank. Water fill is activated simultaneously with the black flush lever. The lever should be held open for several seconds to allow adequate flush water coverage of the bowl. The water fill lever (white), can be operated independently of the flush lever if more than the normal 2" automatic bowl refill water is desired.

### **PEDAL FLUSH MODEL**



**Add Water**

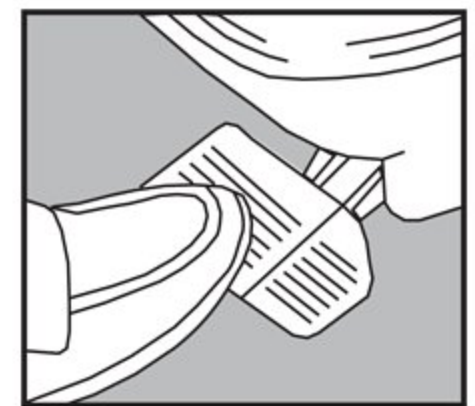

**Flush**

### **HAND FLUSH MODEL**



**Add Water**

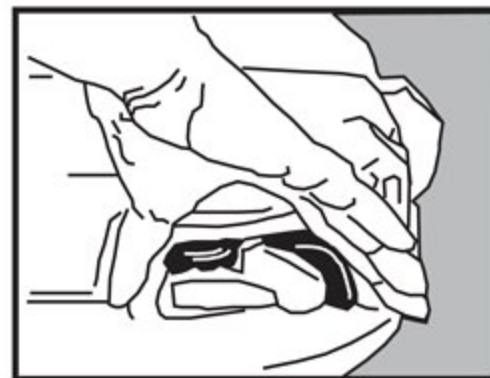

**Flush**

Unnecessary frequent flushing of the stool will quickly deplete your fresh water supply and fill your holding tank. If the black water tank becomes full, you will no longer be able to flush the stool until the tank can be drained.

Follow the toilet manufacturer's recommendations supplied with the toilet for cleaning and maintenance. If you have a toilet that differs from the description given here, make sure to follow the manufacturer's advice for operation.

## **WATER SYSTEM WINTERIZATION**

If you intend to store your recreation vehicle through periods of subfreezing weather in an unheated environment, it will be necessary to winterize the water system. Damage to water system components will result if proper winterization steps are not taken.

### **Water System Winterization (Class A, Kodiak & 750 Fun Mover)**

1. Level the unit for good system drainage.
2. Drain the waste water tanks (black then grey following drainage guidelines).
3. Turn the water pump switch off.
4. Open all faucets, and water heater drain.
5. Open low point drains on the water lines, including the outside shower.
6. Drain the fresh water tank.
7. When all lines are drained, close water tank valve, all faucets, water heater drain, and low point drains on water lines.
8. Turn water heater bypass valve on to prevent tank from filling with antifreeze.
9. Remove water filter (if installed) and replace with bypass cap to protect filter.
10. If unit is equipped with an ice maker, turn off the water valve.
11. Position antifreeze so siphon hose can be connected to the winterizing connection.
12. Turn valve to position which will allow the water pump to pump from antifreeze container.
13. Turn on the water pump and let each faucet run until antifreeze flows freely from both hot and cold lines. Also run the shower and toilet until antifreeze is visible.
14. If unit is equipped with a washer/dryer turn on and let run until antifreeze is visible and continue to run for 15-20 seconds. Turn cycle selector to rinse cycle to ensure the antifreeze gets into the pump to protect it.
15. Turn off water pump.
16. Pour one cup of antifreeze in every drain to protect the P-traps.

### **Class C Water System Winterization**

1. Level the unit for good system drainage.
2. Drain the waste water tanks (black then grey following drainage guidelines).
3. Turn the water pump switch off.

4. Open all faucets, and water heater drain.
5. Open low point drains on the water lines (pull up and twist valve) and the outside shower to let water drain.
6. Drain the fresh water tank using outside spigot type drains.
7. When all lines are drained, close water tank valve, all faucets, water heater drain, and low point drains on water lines.
8. Turn water heater bypass valve on to prevent tank from filling with antifreeze.
9. Remove water filter (if installed) and replace with bypass cap to protect filter.
10. If unit is equipped with an ice maker, turn off the water valve.
11. Remove water pump line at fresh water tank location and attach siphon hose to fitting.
12. Turn on water pump and let each faucet run until antifreeze flows freely from both hot and cold lines. Also run the shower and toilet until antifreeze is visible.
13. Turn off water pump.
14. Pour one cup of antifreeze in every drain to protect the P-traps.

Before using the system again in warmer weather, completely flush the system with water, flush the toilet, and sanitize the entire fresh water system. When using the recreation vehicle during cold weather and water in a tank or drain line should happen to freeze, you should take immediate steps to thaw it before damage to the system occurs. DO NOT continue to use water system components if such a condition exists. If damage has occurred, make sure to have it repaired before using again.

## **WATER SYSTEM MAINTENANCE AND TROUBLESHOOTING**

As with any mechanical system, your plumbing is subject to the development of problems. Most of these problems can be greatly reduced if not altogether eliminated by following a schedule of planned inspections and maintenance. Neglect of proper maintenance procedures is the usual cause of most water system problems.

Road vibrations and shocks, as well as excessive pressure from some city water sources are the main physical causes of water system damage. It is important to inspect all plumbing joints and fittings often for cracks and leaks. Water leaking from a plumbing joint can cause considerable damage if left unchecked.

A leak somewhere in the fresh water system should be suspected whenever the pump is running and all faucets and valves are closed. When the leaking fitting has been identified, attempt to stop the leak by tightening. DO NOT over tighten. Plastic fittings rarely need to be tightened with a wrench. If these fittings leak after tightening by hand, disconnect the fitting and check for dirt, scale, or other foreign substances which may be causing the leak. Clean the fitting thoroughly and reinstall. If leaking persists, shut off the water supply until the fitting can be properly replaced. Check with your dealer for correct method of replacement, and replacement parts.



Proper winterization procedures of plumbing systems will normally be all that is necessary to prevent the damage caused by freezing. Freezing damage can harm any component of the system, including the water tanks, toilet, pump, and all piping. Be sure to follow the winterization procedures outlined in this manual. Also be sure to discuss any additional precautions that should be taken to winterize your motorhome's plumbing system with your dealer. Local climates vary; and winter maintenance needs may be effected.

Be sure to read the literature supplied with plumbing components, such as the pump, for troubleshooting tips. Also remember that it is possible for an electrical problem to cause water system problems. Lack of power to the pump can be caused by a variety of reasons. If you are unsure of how to locate and/or repair a plumbing problem, it is best to have your dealer or a qualified plumber handle the job.

# APPLIANCES

## **GENERAL INFORMATION**

The following instructions are general in nature and may vary from the appliances in your recreation vehicle. Each appliance should have an individual owner's manual and operating instructions supplied with the recreation vehicle. Please refer to these manuals for more detailed instructions and information on the operation of your particular appliance.

The various appliances in your recreation vehicle will provide homelike convenience while traveling. They have been designed and tested by their manufacturers for maximum service in a recreation vehicle application.

Each appliance in your recreation vehicle is warranted by their respective manufacturer. Be aware that constant improvement in design of the recreation vehicle may mean that an appliance in your recreation vehicle may not yet be covered in this manual. It is extremely important that you review all the literature provided in the manufacturer's information package provided with your recreation vehicle. Fill out and mail any warranty registration cards required by the appliance manufacturer at this time. Be sure to have your dealer go over the operation of the appliances with you, and report any shortages of literature you may have at that time.

It is important that you carefully read all the manufacturer's information provided regarding both operation and maintenance of the appliances. Pay close attention to all safety precautions given, and make sure to follow them. If the instructions for operation of any appliance differ from the instructions outlined in this manual, make sure to use the information provided with the appliance.

Be sure to keep all literature, including this manual with the recreation vehicle for easy reference. If service on any appliance is required, contact your dealer, or an authorized service representative of the appliance manufacturer. Most appliance manufacturers have toll free service telephone numbers for your convenience.

## **REFRIGERATOR**

**MAKE SURE** to read the owner's manual furnished with the refrigerator for complete instructions regarding the operation and maintenance of your refrigerator.

The refrigerator may be powered by either 120 volt electric, or LP gas. A 12 volt supply is also needed for the electronic control functions. Controls for operation are located below the refrigerator door. Controls include a mode selector switch to choose gas or electric operation, or shut the unit off, and a thermostat to set the temperature from a cold to coldest setting. Indicators on the control panel confirm the mode in which the refrigerator is operating, as well as letting you know if the flame has been lost during LP gas operation.

The thermostat should be set on the coldest setting during start up and initial operation. After the unit has run for a while allowing the refrigerator to cool, the thermostat should be lowered to the desired temperature range, which is usually approximately mid-setting.

The freezer compartment is not designed for the quick freezing of food, but to retain frozen food in that state. Foods purchased for storage in the freezer compartment should be frozen when purchased to reduce the load on the refrigerator system. Ice will be made more rapidly if the thermostat is set at its highest position.

**NOTE:** It is important to make sure that refrigerator is level before attempting to start. Once started, the movement encountered during driving should not affect operation. However, when the recreation vehicle is parked, the sensitivity of the refrigerator to be level should be remembered.

**NOTE:** Never fill your refrigerator with large amounts of warm food or liquid. This will lower the temperature and will take a long period of time for the refrigerator to recover.

## **WATER HEATER**

The water heater is automatically filled from the fresh water system, or when the recreation vehicle is connected to an outside water system. Make sure the water heater has been filled before attempting to light it or heat it by electricity.

The water heater is equipped with three inline shut-off valves to aid in winterizing. These valves must be in the proper position to allow water to flow in and out of the water heater.

Read all the literature provided with your water heater before using it. Pay particular attention to any cautions or warnings associated with its use.

When operating, it will provide hot water to the kitchen and bath. There are various styles of water heaters available, including electronic ignition models. Refer to the water heater manufacturer's owner's manual for specific operating instructions.

## **RANGE**



### **WARNING**

**DO NOT** light range if you detect the odor of LP gas before attempting to light it. Follow all safety procedures associated with use of an LP gas appliance and system. **DO NOT** use the range to heat your recreation vehicle. The open flames of the burners can consume the oxygen available in unit.

**MAKE SURE** to read the owner's manual provided by the range manufacturer carefully **BEFORE** using the range, and follow all precautions outlined. Never leave the range unattended when lit.

### **LIGHTING THE RANGE BURNERS**

The range in your recreation vehicle may be a four burner style or three burner style. There may be a pilot light under the range top that must be lit before the top burners can be operated. It is necessary however to make sure that the main LP gas valve on the LP tank is turned on.

## **RANGE HOOD**

### **WARNING**

**WARNING:** Never turn exhaust fan on with filter screen removed. The exposed fan blades pose an injury threat, and dirt and grease deposits which are normally trapped by filter are free to build up in range hood exhaust duct, creating a fire hazard.

The range hood exhausts the air and cooking odors from the kitchen area, as well as provides light for cooking and countertop activities. The exhaust vent on the outside of the recreation vehicle opens automatically when exhaust fan control is activated.

The exhaust filter screen and fan should be cleaned occasionally to remove accumulated dirt and grease. Clean the filter screen in a hot detergent solution.

Some models may not be equipped with an exterior venting range hood, in this case the exhaust is filtered through the filter screen and vented into the interior.

## **MICROWAVE OVEN**

The microwave oven is an appliance that can be used for the convenient and fast defrosting, cooking, or simmering of foods. The oven is controlled by an auto-touch panel which allows it to be programmed for all of its various functions. Make sure to read the literature provided with the microwave oven for detailed information regarding its operation. Be especially sure to follow all precautions outlined in the manufacturer's literature.

Make sure that the oven turntable (when applicable) is in place before operating, and that the movement of the turntable is not restricted. It is important that you select the proper power level for the various foods and operations you will be using. Refer to the operating instructions and the cookbook provided with the microwave for the settings best suited for the food category you are cooking.

The oven should not be adjusted or repaired by anyone except properly qualified service personnel. DO NOT operate the oven if it has been damaged.

## **ROOF AIR CONDITIONER**

The recreation vehicle may be equipped with a roof mounted air conditioner. It operates on **120** volt power, and is located in the living/dining area of the recreation vehicle and also in the bedroom area of some models. The recreation vehicle may come factory equipped with the wiring and necessary bracing for the insertion of an air conditioner, even if it is purchased without the air conditioner installed at the factory.

Refer to the manufacturer's owner's manual for complete operating and service instructions.

Efficiency when using the air conditioning can be increased by closing all windows and curtains, and parking the recreation vehicle in the shade. Air conditioning consumes a large portion of the electric power available in the recreation vehicle, so efficient operation can be an important

consideration. Even though your recreation vehicle is equipped with 30 amp capabilities, be aware that some campgrounds may offer less than 30 amp service. Check what amperage is available before utilizing excessive power that may create a fire hazard or trip breakers in either the recreation vehicle, or the outside power source.

**NOTE:** Always turn off air conditioner (and all electrical appliances) before disconnecting the motorhome from its 120V power source.

**NOTE:** If you cover the outside portion of your air conditioner during periods of storage, make sure to remove protective cover before reusing.

### **AIR CONDITIONER SELECTION SWITCHES (30 Amp Service Only)**

## **WARNING**

**To prevent any chance of asphyxiation, the generator should not be operated while sleeping.**

Some motorhomes may be equipped with two roof mounted air conditioners. One for the front portion of the unit, and one for the rear. This allows you to cool a specific area of the motorhome as needed. However, 30 amp service from the shoreline connection will not support the current draw required to utilize two roof air conditioners at the same time. When using 120V power from the shoreline connection, it is necessary to select one or the other of the two units. It is possible however, to utilize both air conditioning units simultaneously with the 120V power supplied by the generator.

**Some models are not equipped with this switch.**



To make the proper selection of air conditioning units, based on the source of 120V power, a selection switch panel is mounted in the bedroom. The switch panel consists of one 3-position switch that controls both the power to the units as well as proper selection of the source of power.

**Positioning of the switch for various air conditioning combinations when plugged into a shore power source are as follows:**

Switch Centered      No power to either A/C

Switch Down          Rear A/C only, on Shore Power

Switch Up              Front A/C only on shore line power and Rear A/C on generator power

**NOTE:** No power can reach either air conditioning unit if the switch is in the OFF position.

Make sure that when using both air conditioners at the same time from generator power, that you turn on one air conditioner, and allow it to run for a few minutes before turning on the second unit. This prevents overloading the circuits with a dual power surge when the units are started.

Remember that when running both the air conditioners from the generator; utilizing additional 120 volt appliances may cause the generator circuit breaker to trip. Turn both units off before resetting the breaker. If necessary, choose the unit that will be most effective for cooling the area of the motorhome you will be using.

## **FURNACE**

### **WARNING**

**Never operate the furnace if you smell gas.**

Your recreation vehicle is equipped with a central heating system that is made up of a furnace, thermostat, and ducting to carry the heat throughout the recreation vehicle. The furnace may be a self-igniting (electronic ignition) model that does not require the manual lighting of a pilot light for operation.

The furnace is vented to the outside for both intake and exhaust functions. Never store anything in the furnace compartment of the recreation vehicle, or block the exhaust vents on the outside of the recreation vehicle. Take care to keep heat duct registers open and free of obstruction.

Have the entire heating system inspected annually by a qualified service agency to ensure safe and efficient operation. If you suspect a problem at any time with the system, have it taken care of immediately.

Refer to the furnace manufacturer's owner's manual for specific operating instruction.

**NOTE:** Make sure to read all information supplied by the furnace manufacturer, paying particular attention to any warnings or cautions associated with its use.

## **AUDIO AND VIDEO**

There are various audio and video features available for use in the recreation vehicle. These features include a stereo, television(s), VCR, DVD and/or a VCP. Because of the complexity of instruction for these different features, you should refer to the instruction manuals provided with each of them for complete operating information.

## **TV ANTENNA**

### **WARNING**

**Prior to raising the antenna, visually inspect for any obstructions or overhead electrical wires. Damage to the antenna, severe shock, personal injury or death can occur from inadequate clearance.**

### **CAUTION**

**Do not connect any high current devices to antenna power boost circuit. The maximum current rating of circuit is 8 amps at 12V DC.**

## CAUTION

**Always lower the antenna before moving the recreation vehicle. Wind and low obstacles can severely damage or destroy the antenna if it is raised while traveling.**

The roof mounted antenna control is located in the ceiling of the lounge/kitchen area. The antenna can only be used when the recreation vehicle is parked.

To raise the antenna, crank the handle in the up direction as indicated by the arrow on the large control knob. Continue to rotate the handle until you feel resistance (about 13 turns). DO NOT force the handle beyond the point that resistance is felt. Make sure to check your parking location for obstructions before raising the antenna. Also make sure the power boost switch is in the ON position.

When the antenna is up, fine tune the signal by grasping the large rotating knob, pulling it slightly down, and turning it until the clearest picture and sound are available.

To lower the antenna, rotate it with the large control knob until the pointer on the control knob lines up with the pointer on the ceiling plate. The antenna can now be lowered by cranking the handle in the down direction. Continue to rotate the handle until you feel resistance (about 13 turns).

To make sure the antenna is working properly, tune the TV receiver to the nearest station and rotate the antenna for the best picture and sound. Next turn off the switch on the power booster.

Make sure to turn off the power booster when not in use. The booster can drain the battery if allowed to remain continuously activated. There is a red indicator light on the power booster that is illuminated when it is on.

**NOTE:** It is a good idea to visually check the position of the antenna after raising or lowering. Make sure when lowered, that the antenna lines up parallel to the side of the recreation vehicle.



Raising the Antenna



Fine Tuning the Signal

# CARE & MAINTENANCE

## **GENERAL INFORMATION**

Periodic maintenance and cleaning of your recreation vehicle is necessary to retain the dependability, safety, and appearance that will provide you with many miles of trouble free operation, as well as protecting your investment.

Make sure to read and follow all the maintenance tips and schedules that appear not only in this manual, but also in the manuals provided by the chassis manufacturer and various component manufacturers. Keep good records of maintenance functions performed, and make sure to perform all owner obligations as may be required by the chassis manufacturer to keep your warranty in force.

It is also important to note that operating conditions will effect service timetables. Driving in extreme conditions such as heavy dust, continuous short trips, or start and stop heavy traffic means that service durations will be shortened. Discuss service timetables with both your dealer and chassis service representative. Preventative maintenance will pay for itself many times over by catching or preventing problems before they occur. Many repairs costs are greatly increased due to the fact a small problem can begin to effect other parts and systems of the motorhome if left unattended.

If a situation arises involving a maintenance or cleaning activity for which you are not sure of the proper procedure, do not hesitate to contact your dealer, or chassis service representative for information.

## **FIBERGLASS SIDING**

The care of fiberglass siding is essentially the same as any automotive finish. Wash your recreation vehicle at least once a month. Use warm water and a mild detergent to clean the finish. Take care to avoid spraying water directly into refrigerator and furnace vents when washing the recreation vehicle. Remove bird and tree sap droppings, insects, and tar as soon as possible to avoid staining of the finish.

It is important to note that any finish will deteriorate with time. Dulling and fading can be increased by exposure to extreme sunlight, air pollutants, and excessive moisture. Surface weathering of fiberglass does not change the strength of the fiberglass. Regular washing and waxing of exterior surfaces is the best insurance against surface deterioration such as fading, yellowing, or chalking.

If surface deterioration has occurred, check with your dealer for the steps required to restore the finish. Buffing may be necessary in extreme cases. Small cracks appearing in the fiberglass can be repaired by using a fiberglass filler. Allow the filler to harden, sand, and then repaint with gelcoat (check with your dealer for further instructions and product information).

Wax fiberglass surfaces at least once a year with a standard liquid or paste wax. Make sure to follow the directions for use as outlined by the product manufacturer. Make sure to wash and wax your unit out of the hot sun when exterior surfaces are cool.



Storage of the recreation vehicle out of direct sun is also a primary way to help preserve fiberglass finishes.

Physical damage to fiberglass should be taken care of immediately to avoid moisture from entering through breaks and causing problems with interior walls and components. Cover breaks in the fiberglass with plastic, sealing the edges with tape until proper repairs can be made.

**NOTE:** *DO NOT use rubbing compound or any abrasive cleaner or cloth on the recreation vehicle. If using a tar and insect remover, make sure it is safe for use on painted surfaces and striping decals.*

### **EXTERIOR PAINT (Optional)**

The exterior painted finish on the motorhome is of the finest quality. Proper maintenance will assure a long lasting durable finish.

**NOTE:** *Do not wax or polish the exterior for the first 60 days.*

#### **Pressure Washing:**

Extreme caution should be used when using a pressure washer to wash the motorhome, as severe damage to the paint could result. The tip of the pressure washer should never be adjusted to a "pin point" type spray. A fan type spray which disburse the water over a larger area should be used. Also, if the pressure is adjustable, set it to the lowest setting. The spray tip should remain a minimum of 30" away from the surface of the motorhome to ensure safe cleaning.

**NOTE:** *Do not use rubbing compound or other abrasive cleaners on the motorhome exterior. If using a tar and/or insect remover, insure it is safe for painted surfaces and decals.*

#### **Precautionary Measures:**

- Avoid parking under trees or near ocean salt spray.
- Ice or snow should not be scraped from the painted surface. Brush off.
- If the motorhome sets more than 24 hours, remove any front protective covering (bra) while not being driven.
- Commercial washes should be avoided. Wash with cold water using a mild liquid soap. Dry wiping with a dry cloth is not recommended.

#### **When driving -**

- Avoid gravel roads.
- Anti-freeze, gasoline, or window solvent spilled on painted surfaces should be rinsed off with water immediately.
- Rinse off bugs and bird droppings daily with water.

Any exterior finish will deteriorate with time. Dulling and fading can be increased by prolonged exposure to extreme sunlight, air pollutants, and excessive moisture. Surface weathering of fiberglass will not diminish structural integrity. Regular monthly washing and polishing of exterior surfaces is the best insurance against surface deterioration such as fading, yellowing, or chalking.

## CAUTION

**Take care to avoid spraying water directly into refrigerator and furnace vents when washing the motorhome.**

If surface deterioration is apparent, contact a Four Winds International dealer for assistance with finish restoration. Physical damage to the fiberglass, such as cracks, holes, and chips, must be attended to immediately to avoid moisture from entering and causing problems with interior walls and components. Cover these areas with plastic, sealing the edges with tape until proper repairs can be made.

### **SEALS AND ADHESIVES**

## CAUTION

**Failure to maintain seals through regular maintenance can lead to damage of motorhome components, and may be considered abusive treatment under terms of your recreation vehicle warranty.**

It is important to maintain the seals and adhesives of your recreation vehicle to prevent moisture from entering and destroying recreation vehicle components. When washing your recreation vehicle, inspect the seals for signs of drying out and wear. Be aware that weather, sun, and road vibration will have an effect on seals, causing them to dry, crack, or separate. If you are unsure what to look for, have your dealer instruct you, and also show you the correct method for renewing the seals. All exterior seals should be checked and resealed as needed at least every six months.

**NOTE:** *It is especially important to check the seals before and after periods of extended storage or non-use. fall and spring inspections are recommended.*

**NOTE:** *Be aware that moisture can accumulate in locks and hinges of windows and doors, causing damage or faulty operation. Do not force the operation of these components in sub-freezing weather.*

### **FRAME**

Check the condition of the frame regularly. Keep it clean, and repaint as necessary to help avoid rust. It is especially important to keep under-body components clean, when driving the recreation vehicle in the winter in areas where road salts are used.

### **TIRES & RIMS**

Using soap, water, and a medium bristle brush will keep the sidewall clean and the whitewall looking bright.

To keep the rims of the motorhome looking their best, follow these simple steps:

1. Rinse the wheel with high-pressure water to remove any debris, grit or dirt particles.
2. Use a 100% cotton cloth dipped in a mild soap solution to help remove stuck on dirt and grease.
3. Rinse the remaining soap residue from the wheel.
4. Dry the wheel thoroughly with a 100% cotton cloth.

**NOTE:** In areas where hot sun constantly beats down on the recreation vehicle, shading the tires by covering can reduce tire sidewall cracks from forming.

## **ROOF**

Inspection of roof components at least twice a year is very important to make sure seals are not cracked or worn. Proper maintenance of seals is necessary to keep moisture from entering and causing severe damage such as rot, mold, or mildew. If you encounter drying, cracked, or weathered seals, make sure to reseal as necessary. Check with your dealer for the type of caulking required for roofs and correct methods of resealing. Special sealers are also required for the skylights.

It is especially important to check the seals before and after periods of extended storage or nonuse. Fall and spring inspections are recommended. Four Winds International recommends all roof maintenance be performed by your dealer.

**NOTE:** If your roof should somehow be punctured, cover the puncture to seal out moisture, and have it repaired as soon as possible (check with your dealer).

## **EXTRUSIONS AND ALUMINUM SURFACES**

Clean and wax all extrusions when waxing recreation vehicle sidewalls, to help avoid surface pitting. Special aluminum cleaners are available to restore the original luster to aluminum surfaces. Make sure to follow the instructions for use as outlined on the product package.

Chrome surfaces can be restored with special chrome polish if regular cleaning methods are not successful. Again, make sure to follow product instructions for use.

## **WINDOWS AND DOORS**

Check the seals around the windows at regular intervals. Follow previous instructions for checking the condition of seals and repairing as necessary.

Make sure that windows remain operative by adjusting and lubricating latches and moving parts annually. Also check the condition and operation of the door locks, adjusting and lubricating as necessary. Use powdered graphite or light oil to lubricate moving parts on doors and windows.

Vinyl seals around windows and doors should be cleaned regularly, and kept supple by use of a silicone spray (make sure to follow the directions on the product).

Keep screens and window slides clean and free of debris, to maintain proper operation, and avoid component road damage. Test the operation of all windows occasionally to make sure they are working properly, including closing flush and locks holding tight.

Check with your dealer if you are unsure about the correct methods of lubrication and adjustment.

**NOTE:** Be aware that moisture can accumulate in locks and hinges of windows and doors, causing damage or faulty operation. Do not force the operation of these components in subfreezing weather.

## **LP GAS SYSTEM**

The LP gas system should be checked regularly for leaks and damage. Follow the lines, looking for kinks or flattened spots that could have occurred during travel or maintenance on the recreation vehicle. The entire system, including regulator pressure, should be checked annually, or whenever you suspect a problem, by a qualified LP gas service technician using proper equipment. The method of checking the system for leaks, and LP gas safety precautions can be found elsewhere in this manual.

**NOTE:** Line pressure for LP gas appliances should be checked at least every six months. Most LP gas suppliers have equipment to make the test for you. The correct line pressure for all of the LP gas appliances is 11" of water column pressure.

## **DRAINAGE SYSTEM**

The drainage system, including the tanks and associated drain piping should be periodically inspected for road damage. Any deterioration of the sealant around joints and fittings should be repaired immediately.

Check the operation of the termination valves. If they pull or close with effort, lubricate the shaft and slide valve with spray silicone. Termination valves that leak should be repaired or replaced as soon as possible.

Sometimes, a buildup of paper or other material in the inside groove of the termination valve can obstruct the valve and cause it to seat improperly. If you suspect that this is occurring, the valve can be removed from the drainage line by removing the four screws that hold it in place and sliding it out. The valve groove may then be cleaned out with a screwdriver or similar tool. Replace the valve in the line and reinstall the screws to secure it in place.

## **TV ANTENNA**

To lubricate the elevating gear, apply a liberal amount of silicone spray lubricant to the elevating gear with the lift in the down position. Run the lift up and down a few times to distribute the lubricant over the gears.

If rotating the antenna becomes difficult, normal operation can be restored by lubricating the bearing surface between the rotating gear housing and the base plate. Any spray type silicone lubricant may be used.

Elevate the antenna and remove the set screw from the rotating gear housing (see illustration). Spray lubricant into hole and around the edges of the gear housing. Rotate the gear housing until the lubricant coats the bearing surfaces and the antenna rotates freely.

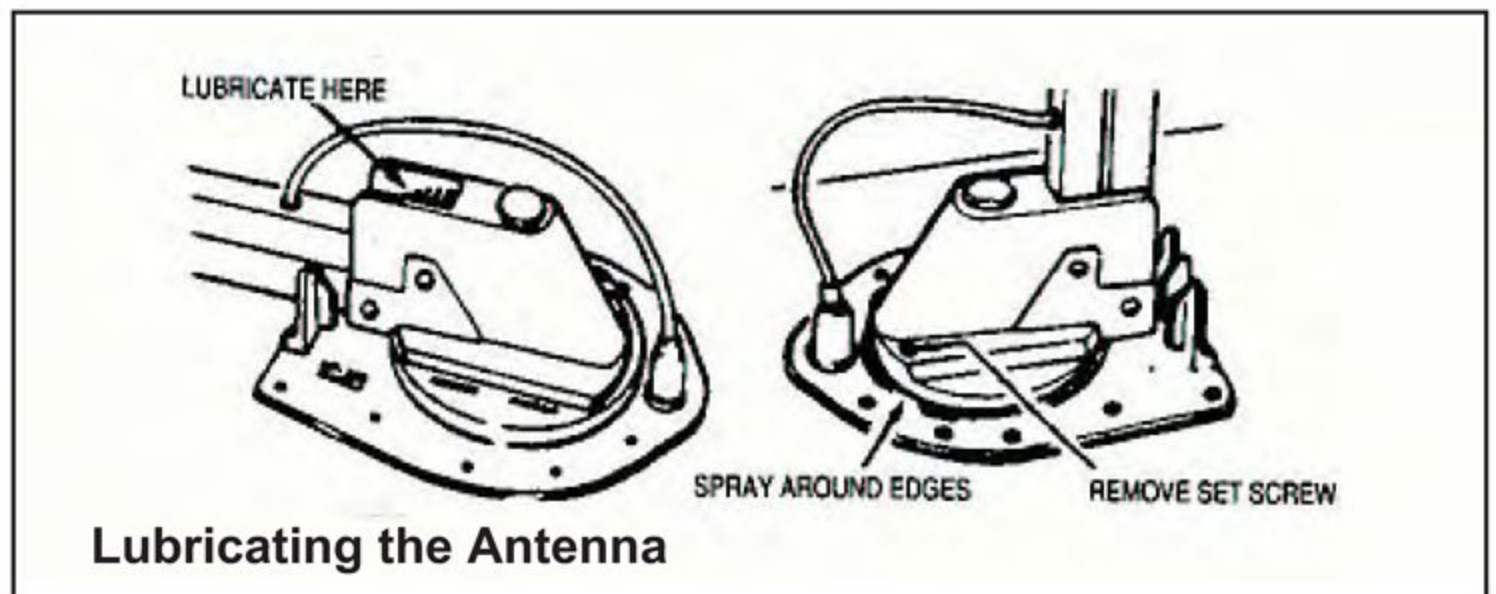

## **EXTERIOR LIGHTS**

Make sure to check the operation of all exterior lights often. Check identification, clearance, turn signal, brake, and backup lights to make sure they are working correctly. Replace burnt out bulbs as soon as possible.

Your new Class A motorhome is equipped with a composite headlamp system. Composite headlamps are designed much differently than the sealed beam units of the '70-80s; they are a plastic lens and chrome plated reflector assembly designed around a replaceable halogen bulb. Composite lamps produce significantly greater light offering better visibility and safety for the driver. Composite lamps also offer the convenience of a low cost replaceable bulb, making the maintenance of the headlamp an easy task.

Seeing at night is what it is all about, with that in mind we have a few maintenance tips to keep your headlamps functioning properly.

### Exterior Lights Maintenance:

**Condensation** occurs when the air inside the lamp assembly, through atmospheric changes, reaches the "dew point". When this takes place, the moisture in the air within the lamp assembly condenses, creating a ***fine mist or white fog*** on the inside surface of the lamp lens or chrome reflector surfaces. The headlamps are designed to remove accumulated moisture vapor by expelling it through a vent system as the light warms up. The vent system operates at all times, however it is most effective when the lamps are on and the vehicle is in motion. Since most RV's are parked for long periods of time, they have a greater chance of condensation build up.

- Check headlamp regularly for condensed water drops (daily in high humidity areas).
- If small drops of condensed water are noted, drive your RV with headlamps "ON" or just turn "ON" the headlamps. This will evaporate the condensed water drops and will avoid water being accumulated. Depending on the size, shape and location of the lamp on the RV, and the atmospheric conditions occurring, the amount of time required to clear the lamp may vary from 2 to 6 hours.
- Check your vent tubes, this will be a small rubber hose or plastic cap located on the back of the light, make sure that they are free of dirt and the rubber is not cracked and dried out. If the vent tubes are clogged or cracked and dried out the vent system will not work correctly, allowing condensation to build up in the lamp. If the tube is cracked or dried out please replace it, replacement parts can be acquired from your RV Dealer.

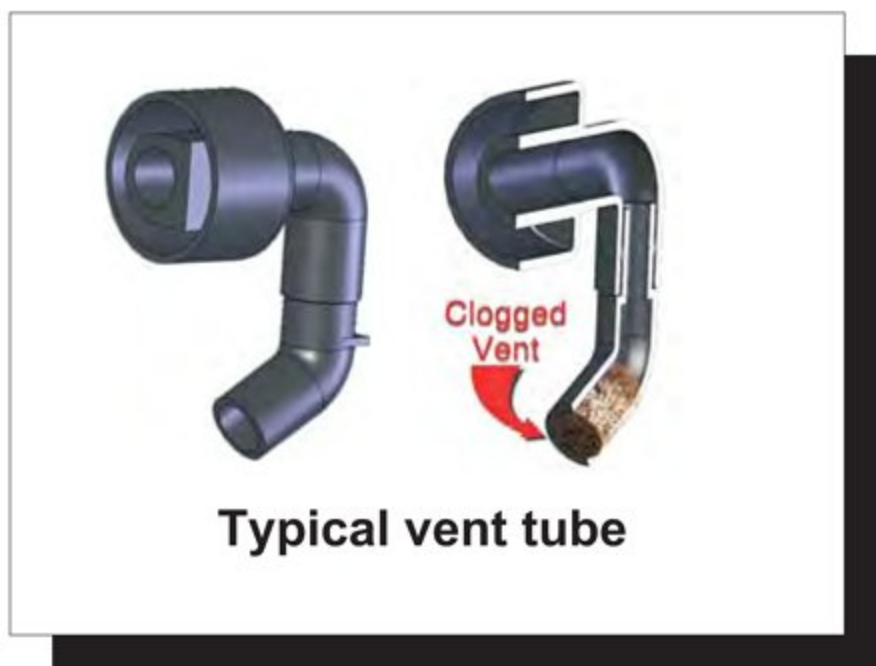

**Cleaning is the most effective maintenance that you can perform on your lights, dirt and road grime build up can cut light output by 40% or more.**

- When cleaning your headlamps, please observe the following: do not rub them dry, and never use abrasives or strong solvents. Remove dirt and contamination, such as insects, by soaking with shampoo and then rinsing with plenty of water. Always use a de-icer spray to remove accumulated ice and snow; never use a scraper.
- Headlamp seals should not be directly sprayed with high pressure (home or industrial) wash systems. Damage to the seal can occur, causing the housing to leak water.
- **Chemicals:** Composite headlamps have a polycarbonate lens, which is very sensitive to a variety of chemicals. Contact with certain chemicals can cause crazing, softening or cracking of the lens, which would require replacement of the entire lamp housing. **The following chemicals are suspected to cause similar results. Mild soap and water is recommended for the cleaning of your lamps.**

**Do NOT use the following:**

Acetone	Gasoline	Oils
Agitene®	Kleenol Plastics	Pink Lux® (phosphate free)
Ajax®	Lemon Joy® (phosphate free)	Stanisol Naphtha®
Benzyl	Lestoil®	Texiz-8006, 8129, 8757
Carbon Tetrachloride	Liquid Cleaner - 8211	Toluol
Chlorinated	Liquid Detergents	Tricholor
Citrus Orange Cleaners	Lysol®	Triclene®
Diversol ®	Methyl Ethyl Keyton (MEK)	

Damage to the lamp assembly by these chemicals is not cover under Kaper II's warranty program.

**Replacement of the halogen bulb:**

- When replacing the halogen bulb do not touch the glass portion of the bulb with your bare hands since even small amounts of impurities burn into the surface and reduce the service life of the bulb. Use a clean cloth, paper napkin, or similar material to hold the bulb during installation. With most bulbs you will not need to touch the glass part to install the bulb.
- Whenever working on any electrical system, switch off the electrical accessory you are working on or refer to the electrical system section of your owner's manual. Failure to do this could result in short circuits.
- To prevent injuries and damage, comply with any instructions provided by the bulb manufacturer.

Any questions or comments may be directed to Kaper II, Inc. at 1-800-336-2011.

## **APPLIANCES, SINKS, AND COUNTERTOPS**

Clean with hot soapy water or a good liquid cleaner. Avoid using abrasive cleaners. Never use steel wool on stainless steel, since the steel particles left in the sink can rust and become unsightly. Also, when cleaning stainless steel with a mild cleanser, rub gently with the grain, and rinse well. Rinse after each use and wipe dry.

Be sure to remove all food and ice from the refrigerator at the end of each trip. Prop the door open slightly to keep the interior dry, and free of mold, mildew, and odors.

Make sure to read all literature provided with each of the appliances, and follow the maintenance instructions included. Pay particular attention to any cautions or warnings included. Also read the rest of this manual, following the instructions for the care and use of appliances. Do not place hot pans directly on countertops, because they can loosen or scorch surface.

## **PRE-FINISHED PANELS AND WOOD SURFACES**

Treat cabinetry and wood surfaces as you would any fine furniture product in your home. Proper care and maintenance of wood products will keep them looking like new for many seasons of use.

Clean pre-finished panels with a spray-type furniture polish. Avoid getting wood surfaces wet. Wipe off and dry immediately if you do get wet. Do not use abrasive cleansers around wood finishes. Clean regularly with a soft cloth and cleaner designed for wood products such as lemon oil or any oil based wood cleaning product. Avoid constant exposure to direct sunlight which can cause fading and drying of wood surfaces.

## **WATER SYSTEM**

Check all hoses, fittings, and connections regularly for leaks and signs of wear. Make sure to keep the system sanitized, and take care to winterize during cold weather (see instructions elsewhere in this manual). Do not allow water to remain in system for extended periods or after a trip.

## **ELECTRICAL SYSTEM**

The electrical system requires minimal maintenance under normal circumstances. Most electrical maintenance in the recreation vehicle involves the chassis and auxiliary batteries. Keeping the batteries properly maintained will help to eliminate many frustrating electrical problems. Make sure to refer to the index for the location of electrical and battery maintenance elsewhere in this manual.

The generator is another area in which simple preventive maintenance can “head off” problems before they happen. Read the manual supplied with the generator for the care and maintenance required on a regular basis. If you experience electrical problems with your recreation vehicle, make sure to have it checked by a qualified electrician.

## **ROOF VENTS**

Check roof vents regularly for debris that may block air flow or jam the cranking mechanism. Lubricate the cranking mechanism with light oil.

## **ABS PLASTIC**

Many components of the recreation vehicle are constructed of strong, lightweight ABS plastic. Sometimes, it may be necessary to remove stains, or generally clean. A mild solution of soap and water will clean many stains, and should be used initially. Tougher stains may require stronger cleaners, but be sure to read the label to determine if the product is recommended for use on plastics.

Avoid abrasive cleansers (even the liquid and cream types), alcohol based products, and solvents such as acetone and MEK. Gasoline and kerosene should not be used because of the damaging effect they have on the plastic surface, as well as the fire hazard they present. Often the damage caused by solvents, alcohol, and oil based products may not be immediately noticeable, but the plastic is made weaker, and prone to stress cracking.

## **WINTER PRECAUTIONS**

### **Special Tips for Winter Use**

**Water Systems** — If the fresh water storage tank is located inside the coach, the normal heating of the coach during cold weather should be enough to insure its not freezing. In severe cold however, it is wise to monitor the water temperature in the tank, and take appropriate steps to drain and winterize if necessary. In severe cold it may be necessary to open lower cabinet doors at night in both the bath and kitchen areas to keep warmer air circulating around water fixtures.

If you are going to have to leave the coach unheated for any length of time in severe cold conditions, it is best not to keep water in the fresh water tank. It may work best to carry cooking and drinking water with you in plastic jugs instead.

If you will be using your recreation vehicle when conditions fall below the freezing level, it will be necessary to protect the drainage system components from damage by the addition of an approved antifreeze solution as outlined on the product directions. Drain lines which are exposed outside the recreation vehicle are especially susceptible to freezing, and steps should be taken to protect them from damage.

**Food Storage** — In the event the recreation vehicle is left for a period of time without the furnace in operation, canned goods and other foods packed in water should be stored as high as possible, since heat rises. They might also be stored in the refrigerator as insulation against the cold. Store dry foods, and other items that are not damaged by freezing in the lower storage areas.

**LP Gas System** — Make sure to use an LP gas that will vaporize properly in the colder temperatures. Check with your LP gas representative for the proper fuel, and reread the information on LP gas selection in the LP Gas section of this manual (check the Index for the location).

**NOTE:** *It is important to remember that heating with LP consumes gas rapidly, so refill tank immediately when low, to avoid running out completely.*

**Heating** — Use ONLY the furnace to heat the recreation vehicle. It is properly vented to the outside.



**DANGER**

**NEVER USE THE RANGE FOR HEATING - ASPHYXIATION COULD RESULT.**



**Condensation** — Cooking produces large amounts of moisture. Not just as steam from pots and pans, but also as a product of combustion. Make sure to use the exhaust vents and open a window slightly to control the humidity. At night, leave a roof vent and/or a window slightly open.

## **STORAGE PREPARATION**

When storing the recreation vehicle for the winter (or other extreme conditions), certain precautions need to be made to protect it until you open it again for use. Make sure to talk with your local dealer concerning any special requirements for storage in your particular geographic area. The following steps are general, and your dealer can help you choose those that are most appropriate for your needs.

1. Make sure to park the recreation vehicle on a level surface.
2. Make sure to winterize the chassis as outlined in the chassis owner's manual, and also the 120V generator (if so equipped) as outlined in the generator owner's manual.
3. Clean the recreation vehicle thoroughly, both inside and out, as previously outlined including the refrigerator.
4. Make sure all electrical switches and appliances are turned off.
5. Close all the drapes and curtains, and protect the curtains from sun fading by placing foil, or paper between the windows and the screens.
6. Make sure all windows, doors, and vents are closed securely. Cover exterior vents on appliances to prevent moisture and insects from entering during storage.
7. Check the interior of the recreation vehicle periodically while in storage to make sure leaks have not developed, or condensation formed that can cause damage to interior components. Condensation can most readily be observed as moisture accumulation on windows and mirrors. To reduce condensation, make sure to air the recreation vehicle out occasionally during storage.
8. Be sure that both the chassis and auxiliary batteries have the proper electrolyte level and that they are fully charged (specific gravity of 1.260). A discharged battery will freeze and crack the case, ruining the battery. In storage, a battery will lose charge gradually over a 30 to 45 day period, even when disconnected by use of the battery disconnect switch. We recommend that at least monthly the batteries be checked for charge. If the charge is 80% (specific gravity of 1.235) or less, it must be recharged.

You may wish to remove the batteries from the recreation vehicle and store them in a heated area. However, even when warm, the battery charge level must still be maintained, a warm battery accepts charge much more readily however, than a cold one.

Make sure to follow all precautions associated with battery care and maintenance outlined in the electrical section of this manual.

9. Store with as much fuel as possible in the fuel tank to limit condensation buildup.
10. Check engine coolant, making sure antifreeze is sufficient for local temperature extremes.

11. Make sure the tires are inflated to correct pressures.
12. Store the windshield wiper arms and blades inside the motorhome.
13. Let the engine run for a period of time until it is warm. Change the oil and oil filter.
14. Run the air conditioner during this final engine warm up to make sure the compressor seal is lubricated.
15. If snow accumulates on the recreation vehicle, try to remove it as often as you can.
16. A primary concern when winterizing the recreation vehicle is to make sure the water systems are protected against damage caused by freezing. Follow the water system winterizing procedure outlined in the Water and Drainage section of this manual (check the Index for location).

Be sure to read the rest of this manual, and follow any additional information on storage, cleaning, and winterizing procedures.

## **MOLD**

### **What are molds?**

Molds are microscopic organisms that naturally occur in virtually every environment, indoors and out. Outdoors, mold growth is important in the decomposition of plants. Indoors, mold growth is unfavorable. Left unchecked, molds break down natural materials, such as wood products and fabric. Knowing the potential risks is important for an owner to protect their investment.

### **What factors contribute to mold growth?**

For mold growth to occur, temperatures, indoor or outdoors, must be between 40° and 100° Fahrenheit and also have a source of moisture, such as humidity, standing water, damp materials, etc. Indoors, the most rapid growth occurs with warm and humid conditions.

### **How can mold growth be inhibited?**

By controlling relative humidity, the growth of mold and mildew can be inhibited. In warm climates, use of the air conditioner will reduce the relative humidity. Vents are located in the bathing and cooking areas and constant use is advised during food preparation and bathing, even during cold weather. Additionally, opening a window during these activities will assist in ventilation. In extremely humid conditions, the use of a dehumidifier can be helpful.

**NOTE:** *If using a dehumidifier, please read and follow all manufacturer instructions and recommendations to the use and cleaning of the dehumidifier.*

## **MOLD & MOISTURE EFFECTS OF PROLONGED OCCUPANCY**

The motorhome was designed primarily for recreational use and short-term occupancy. If you expect to occupy the motorhome for an extended period, be prepared to deal with condensation and the humid conditions that may be encountered. The relatively small volume and tight compact construction of modern recreation vehicles mean that the normal living activities of even a few occupants will lead to rapid moisture saturation of the air contained in the motorhome and the appearance of visible moisture, especially in cold weather.

Just as moisture collects on the outside of a glass of cold water during humid weather, moisture can condense on the inside surface of the motorhome during cold weather when relative humidity of the interior air is high. This condition is increased because the insulated walls of a recreation

vehicle are much thinner than house walls. Estimates indicate that a family of four can vaporize up to three gallons of water daily through breathing, cooking, bathing, and washing. Unless the water vapor is carried outside by ventilation, or condensed by a dehumidifier, it will condense on the inside of the windows and walls as moisture, or in cold weather as frost or ice. It may also condense out of sight within the walls or the ceiling where it will manifest itself as warped or stained panels. Appearance of these conditions may indicate a serious condensation problem. When you recognize the signs of excessive moisture and condensation in the motorhome, action should be taken to minimize their effects. For tips on controlling condensation see the "Tips To Controlling Condensation" section below.

**NOTE:** *Your motorhome is not designed, nor intended, for permanent housing. Use of this product for long term or permanent occupancy may lead to premature deterioration of structure, interior finishes, fabrics, carpeting, and drapes. Damage or deterioration due to long-term occupancy may not be considered normal, and may under the terms of the warranty constitute misuse, abuse, or neglect, and may therefore reduce the warranty protection.*

## **CONDENSATION**

Construction of your **Four Winds International** RV is the best in the industry when it comes to strength and energy conservation. These new building techniques greatly reduce air exchange between the inside and outside, thus creating a very airtight vehicle.

This creates some problems that can easily be resolved by airing out the vehicle on a regular basis, especially in warm, humid conditions and after storage. Also, during prolonged cold weather where the heating system is in use, other procedures should be followed as detailed in the last suggestion in the Safety portion of this manual. Due to the physical size of a recreation vehicle, moisture condensation can be more of a problem in an RV than in the average home. However, utilizing proper condensation reduction techniques will greatly reduce the possibility of issues relating to condensation problems.

Therefore, it is imperative that roof vents, windows, and/or range hood vents are opened while cooking, using the shower, washing or drying clothes, or any other steam or moisture-generating activity. Opening vents or windows on opposite sides or ends of the RV is an effective method of creating a "cross-flow" of air movement, and assisting in the reduction of water or steam within the living quarters. Use of dehumidifiers may be advisable or required in high humidity climates, dependent on the cooking or water use habits of the recreation vehicle owner. Any water spills from showers, sinks, open windows, or leaks must be dried immediately utilizing dehumidifiers, fans, and vacuum sweepers rated for wet use, to prevent further damage to the vehicle and contents. Professional carpet cleaning water extraction services are recommended to remove moisture from carpeting. Parking the RV in a shaded area during the summer will also reduce the resultant condensation from operating the air conditioner during high humidity and high temperature situations. Avoid overfilling closets and always load the drawers and cabinets in a manner, which allows air circulation. Clothes must be completely dry prior to storage and should be hung loosely in closets, to allow air circulation within the closet. Dirty laundry must be stored in well-ventilated areas and must not lie around while wet or damp. Clothes dryers must be vented to the exterior of the RV.

Reduction of condensation will also diminish the possibility of your unit's insulation from becoming damp and dropping in efficiency.

## **TIPS TO CONTROLLING CONDENSATION**

To avoid condensation problems, try to follow these tips to help alleviate excess moisture.

Allow excess moisture to escape to the outside when bathing, washing dishes, hair drying, laundering, and using appliances and non-vented gas burners.

Always use the vent hood when cooking.

Keep the bathroom door closed and the vent or window open when bathing and for a period of time after you have finished.

Do not hang wet clothes in the motorhome to dry.

In hot weather, start the air conditioner early as it removes excess humidity from the air while lowering the temperature.

Keep the temperature as reasonably cool during cold weather as possible. The warmer the vehicle, the more cold exterior temperatures and warm interior temperatures will collide on wall surfaces, thus creating condensation.

Use a fan to keep air circulating inside the vehicle so condensation and mildew cannot form in dead air spaces. Allow air to circulate inside closets and cabinets (leave doors partially open). Please keep in mind that a closed cabinet full of stored goods prevents circulation and allows the exterior temperature to cause condensation.

The natural tendency would be to close the vehicle tightly during cold weather. This will actually compound the problem. Simply put, you need to remove some of the warm air, and allow some cool outside air to get inside the vehicle, so the furnace will not recycle the humid interior air.

Use fluorescent lights and minimize prolonged use of incandescent lights, which produce heat and contribute to condensation in the roof above the ceiling lights.

## **OTHER WAYS TO MANAGE MOISTURE**

### **Interior Care of Your Motorhome**

Signs of excessive moisture can be obvious, such as water droplets forming on surfaces or wet carpet. Conversely, signs of excess moisture can be subtle, such as condensation forming on metal surfaces. When symptoms appear it is important to timely determine the cause of the excess moisture and take appropriate corrective action to prevent moisture related damage.

### **Control Relative Humidity**

Monitoring and controlling relative humidity within the motorhome is one of the most important steps to minimize the risk for moisture-related damage. Ideally, a relative humidity should be at 60% or less. Relative humidity can be monitored utilizing a portable hygrometer, a small device that measures temperature and relative humidity. Hygrometers are available at electronics or building supply stores for approximately thirty dollars (\$30).

Use exhaust fans, the air conditioner, and/or a portable dehumidifier to manage moisture inside the motorhome to maintain relative humidity at 60% or less. In cold climates, relative humidity may need to be at 35% or less to avoid window condensation issues.

**NOTE:** *If using a dehumidifier, please read and follow all manufacturer instructions and recommendations to the use and cleaning of the dehumidifier.*

If the motorhome is used the majority of the time in a hot-humid climate, it may be difficult to keep relative humidity below 60%. A dehumidifier will help, but it is important to check the condensation (water) collection bucket regularly or discharge the condensation (water) directly to a drain.

### **Avoid Drastic Thermostat Setbacks**

Cooler surface temperatures increase the potential for condensation and surface mold growth. To minimize the opportunity for condensation to form on interior surfaces, maintain a comfortable temperature in your motorhome, and avoid nighttime setbacks of 10 degrees or more. Drastic setbacks that reduce the indoor air temperature quickly can increase the chance for airborne moisture to condense on cool surfaces such as windows. If you are away from your motorhome for an extended number of days, we recommend that you do not set the temperature back without taking other measures to manage relative humidity, including operating a dehumidifier with a continuous drain.

### **Manage Window Condensation**

Window condensation issues can be identified by water or ice-build up, usually at the base of the window. The majority of these problems can be addressed by managing moisture generated inside the motorhome. Minor condensation issues are not unusual, especially for motorhomes used in colder climates. The key is to manage this small amount of moisture if evident by wiping the surface, and as discussed previously, maintaining a reasonable relative humidity within the unit.

To help minimize window condensation, use exhaust fans vented to the outside, avoid drastic changes in thermostat settings, do not use "vent-free" heaters and use window coverings wisely. For example, make sure to open curtains or blinds during the day to allow air to circulate and warm the window surface.

### **Carpet Care and Moisture Management**

To keep your carpet serviceable and looking new for years to come, the carpet should be cleaned when it shows sign of discoloration or traffic patterns. The use of a professional steam cleaning system is recommended for cleaning the carpet, unless otherwise noted. To manage moisture from the cleaning process, the cleaning system needs to be capable of extracting the excess water from the carpet after it has been cleaned.

## **CAUTION**

**Be sure the carpet is thoroughly dry before closing up the motorhome for storage. Water from the cleaning process can cause significant damage to the motorhome if the carpet is not completely dry before closing up for an extended period.**

### **Storage and Other Isolated Areas within the Motorhome**

Storage areas are more difficult to condition since the areas are isolated from the main body of the RV. The surface of these areas are more at risk for condensation and surface mold growth. To minimize this risk, clean storage areas regularly, and allow an air space between stored items and the exterior wall to promote air circulation.

### **Use of Un-vented Combustion Equipment**

Un-vented combustion equipment, such as propane stovetops are a source of moisture within the motorhome. For every gallon of fuel consumed, approximately one gallon of water vapor is evaporated into the air. Whenever possible, operate an exhaust fan in combination with the use of any un-vented combustion appliance within the motorhome. Water vapor and other combustion byproducts should be vented to the exterior of the motorhome. The motorhome

owner should strictly follow use and maintenance instructions for safe operation of any combustion equipment, particularly un-vented equipment.

### **Exterior Care of Your Motorhome**

The exterior shell of the motorhome is the primary weather and moisture barrier. Over the life of the motorhome, the shell will require regular care and maintenance. The shell includes the roof, sidewalls, windows, doors, and under-carriage of the vehicle. Particular attention needs to be devoted to ensure these components are maintained to ensure a tight barrier against bulk water intrusion.

The shell should be inspected periodically for tears, gaps, and condition of sealants. Areas that require maintenance should be re-sealed utilizing a similar, high quality sealant of similar characteristics as the original sealant.

Particular attention should be devoted to ensure the slideout(s) are functioning properly. Each time a slideout is used it should be inspected to ensure proper operation and sealing. The slideout gaskets should also be inspected to ensure proper sealing when the slideout is operated.

### **Use of Your Motorhome**

It is important to remember that the square footage of the motorhome is significantly less than that of a single family residence. This fact alone will elevate the relative humidity because there is less volume of air to help absorb or dissipate the humidity. For example, showering and cooking create a lot of humidity in a small area. In these instances, use of an exhaust fan and opening windows should reduce the relative humidity, particularly when living in the motorhome for an extended period.

## **CAUTION**

**NOTE: The motorhome is not designed, nor intended, for permanent housing. Use of this product for long term or permanent occupancy may lead to premature deterioration of structure, interior finishes, fabrics, carpeting, and drapes. Damage or deterioration due to long-term occupancy may not be considered normal, and may under the terms of the Limited Warranty constitute misuse, abuse or neglect, and may therefore reduce the Limited Warranty protection.**

### **Severe Environments**

Prolonged use of your RV in severe environments - for example in extremely cold or hot-humid climates, will require extra care and maintenance to avoid moisture-related issues.

In both extremely cold and hot-humid climates, more attention needs to be focused on controlling relative humidity within the motorhome. It also may require the use of a portable dehumidifier to manage relative humidity within an acceptable range.

**NOTE: If you have any questions regarding moisture-related issues for different environments you may inhabit, contact Four Winds International.**

## **Storage of your Motorhome**

During those periods when your motorhome is not in use, care must be taken to ensure moisture sources are addressed. Ideal storage of your motorhome would be in an enclosed climate controlled environment. When this is not possible, the following steps should be taken to ensure moisture is controlled:

- a. Turn off all water sources;
- b. Turn off all combustion appliances;
- c. Drain the water tank(s);
- d. Drain the water heater;
- e. Open all closets, cabinet doors and drawers;
- f. Close all windows and entrance doors;
- g. Open a vent or a window enough to allow for some limited ventilation air flow, but not so far as to allow snow or rain to enter;
- h. When storing the motorhome in high humidity climates (ambient relative humidity is greater than 60% year round), add a dehumidifier drained to exterior to control humidity inside the motorhome during storage.

## **Wet Areas**

Areas that are exposed to water spills or leaks should be dried as soon as possible and definitely within 24 to 48 hours. Drying areas quickly minimizes the chance for moisture damage and possible mold growth, which can begin to form colonies in 48 hours. A variety of methods can be used to help the drying process:

- Remove excess water with an extraction vacuum.
- Use a dehumidifier to aid drying.
- Use portable fans to move air across the surface.
- Because moisture is key to mold issues, treat all signs of condensation and spills seriously and deal with promptly. Failure to deal with a moisture issue promptly may cause more severe issues where none initially existed, or may make a small problem much worse.
- Learn to recognize signs of mold - don't paint over or cover up suspicious discoloration until you are sure it is not mold. The affected surface must first be cleaned and dried; residual staining may be painted;
- Be sure to understand and eliminate the source of moisture accumulation as a part of the clean-up. Otherwise, the same issues will simply reoccur; and
- Small amounts of mold should be cleaned as soon as it appears. Small areas of mold should be cleaned using a detergent/soapy solution or an appropriate household cleaner. Goves should be worn during cleaning. The cleaned area should then be thoroughly dried. Dispose of any sponges or rags used to clean mold.

# PERIODIC MAINTENANCE CHART

ITEM	Ea. Trip	Ea. Mo	3 Mo	6 Mo	Ea Yr	As Req	PROCEDURE
Fiberglass Exterior		X					Wash with warm water & mild detergent
				X			Wax with liquid or paste wax
Roof & Roof Components				X			Inspect & reseal as needed
					X		Lubricate roof vent mechanism w/light oil & clean completely
Windows & Doors		X					Check vinyl seals when washing exterior
			X				Check seals for damage & repair as needed
			X				Lubricate door hinges & step components with WD40
					X		Adjust & lube window latches with powdered graphite or light oil
					X		Lube door locks & strike pocket, incl. ext. storage & access drs
Seals & Adhesives		X				Inspect & reseal as necessary	
LP Gas System						X	Check for leaks & road damage
					X		Have qualified serviceman check pressures & complete system
Water Drainage		X					Check hoses, fittings & connections for leaks & signs of wear
	X						Check drainage system for leaks & road damage
						X	Sanitize system
					X		Winterize system depending on local seasonal conditions
Electrical System		X					Check GFCI circuits
						X	Perform maint. on generator as outlined in generator manual
						X	Check & service batteries
Appliances	X						Remove food & ice from refrigerator after each trip
		X					Clean fan blades & wash filter on range exhaust hood
		X					Check for obstructions & dirt on exterior appliance vents
Safety Equipment					X		Clean smoke detector components
	X						Test smoke detector operation
		X					Check fire extinguisher pressure & condition
Carpeting	X						Vacuum after each trip
						X	Clean
Wood Surfaces		X					Clean pre-finished panels & wood
Seats						X	Lubricate all mechanisms & inspect for proper operation
						X	Check all seat belt buckles, release mechanisms & belt webbing
Chassis & Components						X	Follow chassis lubrication & maint procedures & schedules
Weight & Distribution	X						Be sure unit is within specified load limits & weight distribution



## VENDOR CONTACT INFORMATION

Chevrolet	877-424-3878
Ford	800-444-3311
Workhorse	877-946-7731
A & E Awnings	800-216-5115
ASA	800-688-3135
Atwood Mobile Products	800-825-4328
Dometic	800-544-4881
Equalizer	800-846-9659
Esco	574-264-4756
Evans / Tempcon	800-878-7147
Fantastic	800-521-0298
Flexsteel	574-831-4050
Guardian RV	800-333-1322
Hehr Windows	574-935-5122
Intellitec Products	800-251-2408
Interstate	800-541-8419
Kaper II	800-336-2011
KIB Enterprises	574-262-0578
KVH Industries	410-847-3327
Kwikkee Products	800-736-9961
Magnum Teknologies	425-353-8833
Mor/Ryde	574-293-1581
Norcold	800-543-1219
Onan	800-888-6626
Sharp	800-237-4277
Shurflo	800-854-3218
Sony	800-442-7717
Splendide	800-356-0766
Thetford	800-354-4135
Trimark	800-477-0343
Velvac	800-783-8871
Ventline	574-848-4491
Viracon	800-533-0482
Visteon	800-847-8366
Winegard	800-288-8094

# INDEX

	Chapter - Page		Chapter - Page
ABS Plastic Maintenance . . . . .	12-9	Breakers, Circuit . . . . .	9-10
Adhesives & Seals . . . . .	12-3	Carbon Monoxide Alarm . . . . .	2-4
Air Conditioner Selection Switches . . . . .	11-4	Care & Maintenance . . . . .	12-1
Air Conditioner, Roof . . . . .	11-3	Cargo Van Safety . . . . .	2-12
Air Conditioner . . . . .	5-3	Carpet Care . . . . .	12-14
Alignment. . . . .	4-5	CD Player . . . . .	5-6
Amp (50) Shore Power . . . . .	9-2	Chassis Instrument Panel . . . . .	5-1
Amp (30) Shore Power . . . . .	9-1	Chassis Checks . . . . .	3-3
Antenna, Maintenance . . . . .	12-5	Child Restraints . . . . .	2-10
Antenna, TV. . . . .	11-5	Cigarette Lighter . . . . .	5-2
Appliances, Maintenance . . . . .	12-8	Circuit Breakers . . . . .	9-10
Appliances . . . . .	11-1	Compartments, Storage . . . . .	6-5
Audio And Video . . . . .	11-5	Condensation . . . . .	12-14
Automotive 12 Volt System. . . . .	9-5	Condensation . . . . .	12-12
Awning . . . . .	7-3	Connecting To An Outside Power Source . . . . .	9-1
Batteries . . . . .	9-3	Converter, Power. . . . .	9-7
Battery Isolator . . . . .	9-6	Countertops, Maintenance . . . . .	12-8
Battery Disconnect Switch . . . . .	9-8	Dash Controls . . . . .	5-1
Battery Charging . . . . .	9-8	Dash Heater . . . . .	5-3
Battery . . . . .	9-4	Dash Switch Panel . . . . .	5-6
Battery Isolator Controller . . . . .	9-6	Dinette . . . . .	6-7
Battery Maintenance . . . . .	9-4	Door, Entry . . . . .	7-1
Battery Safety . . . . .	9-3	Door Maintenance . . . . .	12-4
Beds . . . . .	6-6	Doors. . . . .	6-5
Brakes, Foot Service . . . . .	4-1	Drainage System, Maintenance. . . . .	12-5

	Chapter - Page
Drawers . . . . .	6-5
Drive Train . . . . .	4-6
Driving. . . . .	4-11
Driving Lights . . . . .	5-6
Egress Window . . . . .	2-11
Electrical System . . . . .	9-1
Electrical System Maintenance . . . . .	12-8
Emergency Start . . . . .	5-6
Emergency Stopping And Towing. . . . .	4-13
Engine Cooling System. . . . .	4-6
Engine Access . . . . .	4-6
Entry Door . . . . .	7-1
Exterior Lights Maintenance . . . . .	12-6
Exterior Paint . . . . .	12-2
Exterior Care . . . . .	12-15
Extrusions & Alum. Surfaces, Maintenance .	12-4
Fan . . . . .	5-6
Faucets . . . . .	10-9
Fiberglass Siding . . . . .	12-1
Fill, Gravity . . . . .	10-1
Filling The LP Gas Tank . . . . .	8-2
Fire Extinguisher . . . . .	2-4
Fire Safety . . . . .	2-3
First Short Trips . . . . .	3-2
Flip Down Style Tire Carrier . . . . .	4-5
Foot Service Brakes . . . . .	4-1
Frame . . . . .	12-3

	Chapter - Page
Fresh Water System . . . . .	10-1
Front Suspension And Alignment. . . . .	4-5
Fuel Filling . . . . .	4-15
Fuel Pump Collision Shutoff Switch (Ford) .	4-15
Fuel Recommendations. . . . .	4-15
Furnace . . . . .	11-5
Fuses, 12 Volt. . . . .	9-10
Generator Remote Switch And Hour Meter .	5-2
Generator Safety . . . . .	9-12
Generator . . . . .	9-11
Gravity Fill. . . . .	10-1
Ground Fault Circuit Interrupter . . . . .	9-9
Headlight Switches . . . . .	5-2
Heated Mirror Switch . . . . .	5-2
Heater, Water . . . . .	11-2
Hills, Dales And Making The Grade. . . . .	4-12
Hoist, Spare Tire . . . . .	4-4
Holding Tanks. . . . .	10-7
Hoses, Pipes, Tubes And Fittings . . . . .	8-4
Humidity Management. . . . .	12-13
Hydraulic Levelers . . . . .	5-7
Hydraulic Slide-Out . . . . .	6-1
Identification . . . . .	3-1
Inflation Info, Tire. . . . .	4-2
Introduction. . . . .	1-1
Inverter . . . . .	9-7
Ladder . . . . .	7-3

	Chapter - Page
Levelers, Hydraulic . . . . .	5-7
Loading . . . . .	4-7
LP Gas Detector Safety . . . . .	2-7
LP Gas Leak Detection System . . . . .	8-5
LP Gas Regulator . . . . .	8-2
LP Gas Safety Precautions. . . . .	8-7
LP Gas System . . . . .	8-5
LP Gas System Winter Precautions. . . . .	12-9
LP Gas System, Maintenance . . . . .	12-5
LP Gas Tank . . . . .	8-2
LP Gas . . . . .	8-1
Maintenance Chart. . . . .	12-17
Maintenance . . . . .	12-1
Microwave Oven . . . . .	11-3
Mirror . . . . .	5-2
Moisture Management. . . . .	12-13
Moisture Effects . . . . .	12-11
Mold. . . . .	2-11
Mold . . . . .	12-11
Monitor Panel . . . . .	10-5
Motorhome/Cargo Van Safety . . . . .	2-12
Non-Hydraulic Slide-Out . . . . .	6-4
Paint, Exterior. . . . .	12-2
Power Converter . . . . .	9-7
Power Mirror . . . . .	5-2
Power Plant And Drive Train . . . . .	4-6
Power Step. . . . .	7-1

	Chapter - Page
Pre-Finished Surface Maintenance . . . . .	12-8
Pump, Water . . . . .	10-2
Range . . . . .	11-2
Range Hood. . . . .	11-3
Rear Vision Tv Monitor . . . . .	5-12
Refrigerator . . . . .	11-1
Regulator Freeze-Up. . . . .	8-3
Rims. . . . .	12-3
Roof Air Conditioner. . . . .	11-3
Roof Vent Maintenance . . . . .	12-8
Roof, Maintenance . . . . .	12-4
Roof Access . . . . .	7-3
Safety Alert Symbols . . . . .	2-1
Safety Precautions, LP Gas . . . . .	8-7
Safety, Battery . . . . .	9-3
Safety, Generator . . . . .	9-12
Sanitizing The Fresh Water System. . . . .	10-3
Seals And Adhesives . . . . .	12-3
Seat Belts . . . . .	2-9
Seating . . . . .	6-6
Shore Power, 30 Amp . . . . .	9-1
Shore Power, 50 Amp . . . . .	9-2
Shore Power . . . . .	9-1
Siding . . . . .	12-1
Sinks, Maintenance . . . . .	12-8
Slide Out Awning . . . . .	7-3
Slide-Out, Non-Hydraulic. . . . .	6-4

	Chapter - Page
Slide-Out, Hydraulic . . . . .	6-1
Smoke Alarm . . . . .	2-4
Spare Tire Hoist . . . . .	4-4
Step . . . . .	7-1
Storage . . . . .	12-16
Storage Compartments. . . . .	6-5
Storage Preparation . . . . .	12-10
Storage. . . . .	6-6
Storage. . . . .	7-2
Switches, Headlight . . . . .	5-2
Tables . . . . .	6-6
Tanks, Holding . . . . .	10-7
Tie-Down Safety . . . . .	2-13
Tire Balancing . . . . .	4-5
Tire Carrier, Flip Down . . . . .	4-5
Tire Inflation Info . . . . .	4-2
Tires . . . . .	4-1
Tires. . . . .	12-3
Toilet . . . . .	10-9
Towing . . . . .	4-12
Trailer Towing. . . . .	4-12
Travel Preparation . . . . .	3-3
TV Antenna . . . . .	11-5
TV Monitor, Rear Vision. . . . .	5-12
TV Antenna, Maintenance . . . . .	12-5
Vendor Contact Information . . . . .	12-18
Vents . . . . .	6-8

	Chapter - Page
Waste Water System . . . . .	10-7
Water & Drainage . . . . .	10-1
Water Heater . . . . .	11-2
Water Pump. . . . .	10-2
Water System Maintenance. . . . .	12-8
Water System Winterization . . . . .	10-10
Water System, Fresh . . . . .	10-1
Water System, Sanitizing . . . . .	10-3
Water System, Waste . . . . .	10-7
Water Systems , Winter Precautions . . . . .	12-9
Weight Information Label . . . . .	4-10
Weight Distribution . . . . .	4-7
Wheel Nut Torque . . . . .	4-3
Wheel And Tire Balancing . . . . .	4-5
Wheels And Tires . . . . .	4-1
Window Condensation. . . . .	12-14
Windows, Maintenance . . . . .	12-4
Windows . . . . .	6-5
Winter Precautions . . . . .	12-9
Winterization, Water System. . . . .	10-10
Wipers . . . . .	5-2
Wood Surfaces, Maintenance. . . . .	12-8

# *Four Winds*

INTERNATIONAL



PO BOX 1486  
ELKHART, IN 46515  
[www.fourwinds-rv.com](http://www.fourwinds-rv.com)  
Revision 09/2006

Windsport   Hurricane   Magellan   Four Winds   Four Winds 5000   Four Winds Siesta   Dutchmen  
Dutchmen Express   Dutchmen Dorado   Chateau   Chateau Sport   Chateau Citation   Fun Mover