

truck campers 2012



DSI

2012 DEALER SATISFACTION INDEX

Lance

**10-YEAR WINNER
DSI QUALITY CIRCLE AWARD**

- EXCELLENCE IN PRODUCT DESIGN
- EXCELLENCE IN ENGINEERING
- EXCELLENCE IN MANUFACTURING
- EXCELLENCE IN CUSTOMER SUPPORT



13 high-quality campers compatible with most import and domestic pickups

Lance



truck campers 2012



Lance

**10-YEAR WINNER
DSI QUALITY CIRCLE AWARD**

- EXCELLENCE IN PRODUCT DESIGN
- EXCELLENCE IN ENGINEERING
- EXCELLENCE IN MANUFACTURING
- EXCELLENCE IN CUSTOMER SUPPORT



13 high-quality campers compatible with most import and domestic pickups

Lance

basic specs + floorplans

Cabover interior headroom height is measured from cabover floor (without mattress) to highest point in cabover ceiling.

Truck bed height is measured from camper's truck bed plate to roof (without air conditioning unit, satellite TV antenna or roof storage system) - including the seven inches for the top of roof ladder.

Overall exterior height is measured from camper's retracted legs to roof (without air conditioning unit, satellite TV antenna or roof storage system) - including the seven inches for the top of roof ladder.

Center of gravity is the balance point of a base-weight camper (with propane and all fluids except black and grey holding tanks) loaded onto a truck - and is measured from where the camper makes contact with the front of the truck bed (the 'lip' at the top of the bed) back towards the rear of the bed and the truck.



Measuring center of gravity

Dry weight is based upon standard base model features - not including options or dealer-installed items.

825 8'6" SHORT BED TRUCK

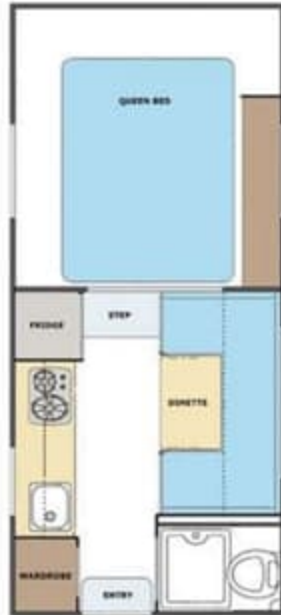

830 8'11" SHORT BED TRUCK

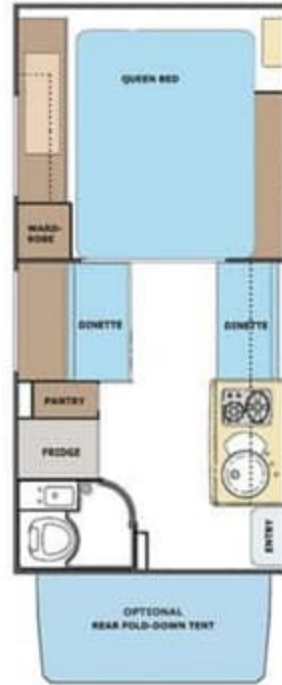

850 8'11" LONG BED TRUCK



855 8'11" SHORT BED TRUCK



SLIDEOUT VERSION
855S



865 8'7" SHORT BED TRUCK



	INTERIOR FLOOR LENGTH	INTERIOR HEIGHT	CABOVER INTERIOR HEADROOM	TRUCK BED HEIGHT	EXTERIOR WIDTH	EXTERIOR LENGTH	OVERALL EXTERIOR HEIGHT (ON CAMPER JACKS)	FRESH WATER TANK (US GALLONS)	GREY WATER TANK (US GALLONS)	BLACK WATER TANK (US GALLONS)	REFRIGERATOR - THREE-WAY POWER MODE (12-VOLT DC, 120-VOLT AC, PROPANE) - CUBIC FEET	PROPANE - SINGLE-GAUGE (NUMBER OF TANKS x US GALLONS)	STANDARD FURNACE OUTPUT (BTUs)	15,000/22,000-BTU DUAL-OUTPUT FURNACE
Lance 825	8'6"	78"	2'9"	6'11"	86"	16'3"	7'6"	30	11	14	3	1 x 5	12,000	-
Lance 830	8'11"	78"	3'2"	8'0"	96"	16'9"	9'2"	30	17	19	5/double-door	1 x 5	20,000	Optional
Lance 850	8'11"	78"	3'2"	8'0"	96"	16'8"	9'2"	30	20	18	5/double-door	2 x 5	20,000	Optional
Lance 855	8'11"	78"	3'2"	8'0"	96"	16'8"	9'2"	30	20	25	5/double-door	2 x 5	20,000	Optional
Lance 855S	8'11"	81"	3'5"	8'3"	96"	16'11"	9'5"	30	20	25	5/double-door	2 x 5	20,000	Optional
Lance 865	8'7"	78"	2'9"	6'11"	86"	16'8"	7'6"	30	14	13	3	1 x 5	12,000	-
Lance 950	9'11"	81"	3'5"	8'3"	96"	17'8"	9'5"	30	20	25	5/double-door	2 x 5	20,000	Optional
Lance 950S	9'11"	81"	3'5"	8'3"	96"	17'8"	9'5"	30	20	25	5/double-door	2 x 5	20,000	Optional
Lance 992	9'11"	80"	3'8"	8'8"	96"	17'9"	9'5"	45	40	30	6/double-door	2 x 5	20,000	Optional
Lance 1050	10'11"	81"	3'5"	8'3"	96"	18'10"	9'5"	30	27	22	6/double-door	2 x 5	20,000	Optional
Lance 1050S	10'11"	81"	3'5"	8'3"	96"	18'10"	9'5"	30	27	22	6/double-door	2 x 5	20,000	Optional
Lance 1181	11'6"	80"	3'8"	8'8"	96"	19'7"	9'5"	42	30	35	6/double-door	2 x 7	20,000	Optional
Lance 1191	11'6"	80"	3'8"	8'8"	96"	20'0"	9'5"	35	35	35	6/double-door	2 x 7	20,000	Optional

truck + camper compatibility guide

These are general guidelines to use when matching a Lance camper to your truck and assumes standard equipment on both the truck and camper. Whether any camper can be used with your truck is dependent on your truck configuration (2WD vs. 4WD, standard cab vs. extended cab, etc.) and its capacities for carrying and/or towing - how much optional equipment is added to the camper - what you tow - and the weight of passengers and all other items you carry in your truck and camper. And because we're unfamiliar with your specific truck and how you intend to use it, Lance makes no warranties or representation - express or implied - as to the performance or reliability of your truck with a Lance camper. For professional guidance, always consult with your Factory Authorized Lance Dealer. They're trained in properly calculating truck/camper rigs.

basic specs + floorplans

Cabover interior headroom height is measured from cabover floor (without mattress) to highest point in cabover ceiling.

Truck bed height is measured from camper's truck bed plate to roof (without air conditioning unit, satellite TV antenna or roof storage system) - including the seven inches for the top of roof ladder.

Overall exterior height is measured from camper's retracted legs to roof (without air conditioning unit, satellite TV antenna or roof storage system) - including the seven inches for the top of roof ladder.

Center of gravity is the balance point of a base-weight camper (with propane and all fluids except black and grey holding tanks) loaded onto a truck - and is measured from where the camper makes contact with the front of the truck bed (the 'lip' at the top of the bed) back towards the rear of the bed and the truck.



Measuring center of gravity

Dry weight is based upon standard base model features - not including options or dealer-installed items.

825 8'6" SHORT BED TRUCK

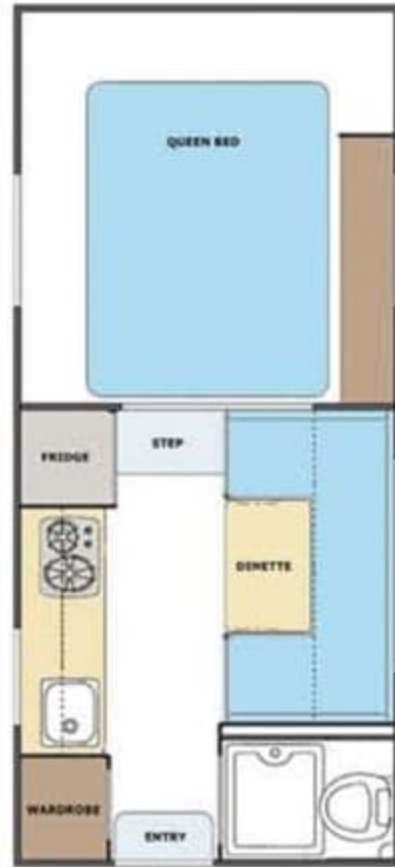

830 8'11" SHORT BED TRUCK

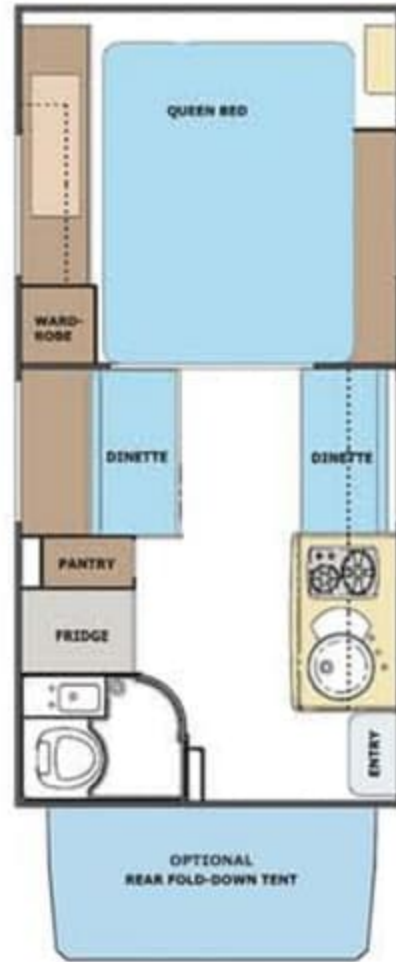

850 8'11" LONG BED TRUCK



855 8'11" SHORT BED TRUCK



SLIDEOUT VERSION
855S



865 8'7" SHORT BED TRUCK



	INTERIOR FLOOR LENGTH	INTERIOR HEIGHT	CABOVER INTERIOR HEADROOM	TRUCK BED HEIGHT	EXTERIOR WIDTH	EXTERIOR LENGTH	OVERALL EXTERIOR HEIGHT (ON CAMPER JACKS)	FRESH WATER TANK (US GALLONS)	GREY WATER TANK (US GALLONS)	BLACK WATER TANK (US GALLONS)	REFRIGERATOR - THREE-WAY POWER MODE (12-VOLT DC, 120-VOLT AC, PROPANE) - CUBIC FEET	PROPANE - SINGLE-GAUGE (NUMBER OF TANKS x US GALLONS)	STANDARD FURNACE OUTPUT (BTUs)	15,000/22,000-BTU DUAL-OUTPUT FURNACE
Lance 825	8'6"	78"	2'9"	6'11"	86"	16'3"	7'6"	30	11	14	3	1 x 5	12,000	-
Lance 830	8'11"	78"	3'2"	8'0"	96"	16'9"	9'2"	30	17	19	5/double-door	1 x 5	20,000	Optional
Lance 850	8'11"	78"	3'2"	8'0"	96"	16'8"	9'2"	30	20	18	5/double-door	2 x 5	20,000	Optional
Lance 855	8'11"	78"	3'2"	8'0"	96"	16'8"	9'2"	30	20	25	5/double-door	2 x 5	20,000	Optional
Lance 855S	8'11"	81"	3'5"	8'3"	96"	16'11"	9'5"	30	20	25	5/double-door	2 x 5	20,000	Optional
Lance 865	8'7"	78"	2'9"	6'11"	86"	16'8"	7'6"	30	14	13	3	1 x 5	12,000	-
Lance 950	9'11"	81"	3'5"	8'3"	96"	17'8"	9'5"	30	20	25	5/double-door	2 x 5	20,000	Optional
Lance 950S	9'11"	81"	3'5"	8'3"	96"	17'8"	9'5"	30	20	25	5/double-door	2 x 5	20,000	Optional
Lance 992	9'11"	80"	3'8"	8'8"	96"	17'9"	9'5"	45	40	30	6/double-door	2 x 5	20,000	Optional
Lance 1050	10'11"	81"	3'5"	8'3"	96"	18'10"	9'5"	30	27	22	6/double-door	2 x 5	20,000	Optional
Lance 1050S	10'11"	81"	3'5"	8'3"	96"	18'10"	9'5"	30	27	22	6/double-door	2 x 5	20,000	Optional
Lance 1181	11'6"	80"	3'8"	8'8"	96"	19'7"	9'5"	42	30	35	6/double-door	2 x 7	20,000	Optional
Lance 1191	11'6"	80"	3'8"	8'8"	96"	20'0"	9'5"	35	35	35	6/double-door	2 x 7	20,000	Optional

truck + camper compatibility guide

These are general guidelines to use when matching a Lance camper to your truck and assumes standard equipment on both the truck and camper. Whether any camper can be used with your truck is dependent on your truck configuration (2WD vs. 4WD, standard cab vs. extended cab, etc.) and its capacities for carrying and/or towing - how much optional equipment is added to the camper - what you tow - and the weight of passengers and all other items you carry in your truck and camper. And because we're unfamiliar with your specific truck and how you intend to use it, Lance makes no warranties or representation - express or implied - as to the performance or reliability of your truck with a Lance camper.

For professional guidance, always consult with your Factory Authorized Lance Dealer. They're trained in properly calculating truck/camper rigs.

950 9'11" LONG BED TRUCK

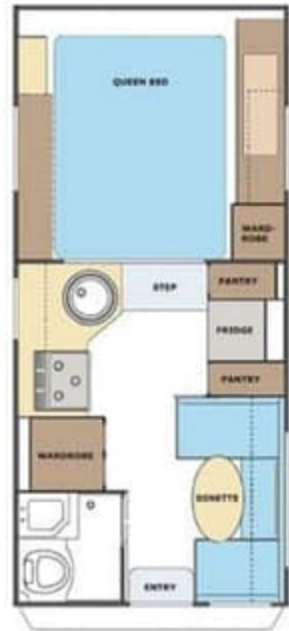

SLIDEOUT VERSION
950S

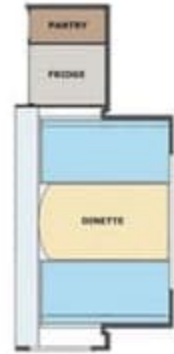

992 9'11" LONG BED TRUCK



1050 10'11" LONG BED TRUCK



SLIDEOUT VERSION
1050S

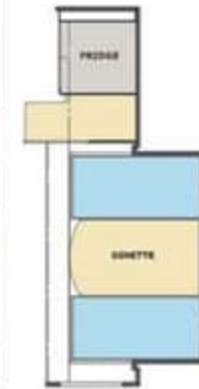

1181 11'6" LONG BED TRUCK



1191 11'6" LONG BED TRUCK

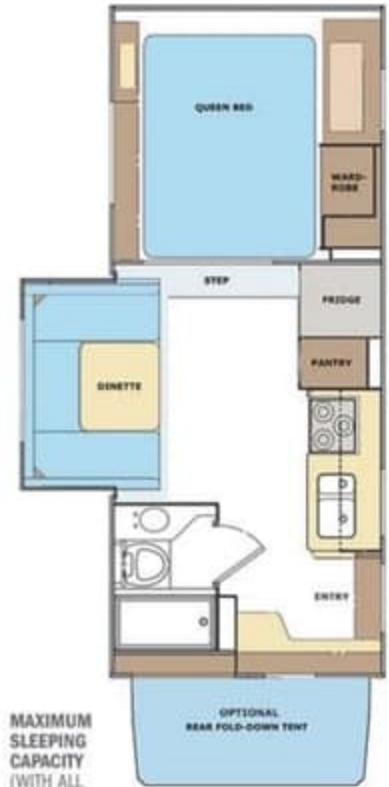

OPTIONAL AIR CONDITIONER OUTPUT (BTUs)

GENERATOR CAPABILITY (PORTABLE UNITS ARE AN OWNER-SUPPLIED, GASOLINE-POWERED GENERATOR - AND OPTIONAL UNITS ARE A 2500-WATT/120-VOLTS AC, PROPANE-POWERED, CUMMINS QNAN® GENERATOR)

SOLAR PANEL CAPABILITY

SHOWER/TOILET CONFIGURATION

CABOVER BED

TWO TWIN-SIZE BEDS CAN REPLACE THE ONE QUEEN-SIZE CABOVER BED - AND WITH EACH TWIN MATTRESS MEASURING 32"x78" - THEIR MATTRESS COVERS CAN BE ZIPPED TOGETHER TO CREATE ONE KING-SIZE CABOVER BED

FOLD-DOWN BUNK BED

FOLD-DOWN BUNK BED SIZE

FOLD-DOWN BUNK BED WEIGHT RATING (POUNDS)

DINETTE BED SIZE

(OPTIONAL) REAR FOLD-DOWN TENT BED SIZE

(OPTIONAL) REAR FOLD-DOWN TENT BED WEIGHT RATING (POUNDS)

STANDARD SLEEPING CAPACITY (BASE MODEL)

MAXIMUM SLEEPING CAPACITY (WITH ALL BEDDING OPTIONS INCLUDED)

CENTER OF GRAVITY

DRY WEIGHT (POUNDS)

OPTIONAL AIR CONDITIONER OUTPUT (BTUs)	GENERATOR CAPABILITY (PORTABLE UNITS ARE AN OWNER-SUPPLIED, GASOLINE-POWERED GENERATOR - AND OPTIONAL UNITS ARE A 2500-WATT/120-VOLTS AC, PROPANE-POWERED, CUMMINS QNAN® GENERATOR)	SOLAR PANEL CAPABILITY	SHOWER/TOILET CONFIGURATION	CABOVER BED	TWO TWIN-SIZE BEDS CAN REPLACE THE ONE QUEEN-SIZE CABOVER BED - AND WITH EACH TWIN MATTRESS MEASURING 32"x78" - THEIR MATTRESS COVERS CAN BE ZIPPED TOGETHER TO CREATE ONE KING-SIZE CABOVER BED	FOLD-DOWN BUNK BED	FOLD-DOWN BUNK BED SIZE	FOLD-DOWN BUNK BED WEIGHT RATING (POUNDS)	DINETTE BED SIZE	(OPTIONAL) REAR FOLD-DOWN TENT BED SIZE	(OPTIONAL) REAR FOLD-DOWN TENT BED WEIGHT RATING (POUNDS)	STANDARD SLEEPING CAPACITY (BASE MODEL)	MAXIMUM SLEEPING CAPACITY (WITH ALL BEDDING OPTIONS INCLUDED)	CENTER OF GRAVITY	DRY WEIGHT (POUNDS)
9000	Portable	Yes (optional)	Wet bath	Queen-size	Optional	Optional	26"x72"	150	36"x72"	-	-	4	5	33"	1730
9000 or 11,000	Portable	Yes (optional)	Wet bath	Queen-size	Optional	-	-	-	42"x78"	50"x72"	1000	4	6	35"	2285
9000 or 11,000	Portable	Yes (optional)	Wet bath	Queen-size	Optional	Standard	26"x72"	150	36"x72"	-	-	5	5	34"	2350
9000 or 11,000	Optional	Yes (optional)	Wet bath	Queen-size	Optional	Standard	26"x72"	150	36"x72"	-	-	5	5	36"	2420
9000 or 11,000	Optional	Yes (optional)	Wet bath	Queen-size	Optional	Optional	30"x72"	150	45"x72"	-	-	5	5	37"	2620
9000	Portable	Yes (optional)	Wet bath	Queen-size	Optional	Standard	26"x72"	150	32"x72"	-	-	5	5	32"	1870
9000 or 11,000	Optional	Yes (optional)	Wet bath	Queen-size	Optional	Standard	26"x72"	150	36"x72"	-	-	5	5	47"	2590
9000 or 11,000	Optional	Yes (optional)	Wet bath	Queen-size	Optional	Optional	30"x72"	150	45"x72"	-	-	4	5	48"	2800
9000 or 11,000	Optional	Yes (optional)	Wet bath	Queen-size	Optional	Optional	30"x72"	150	51"x72"	-	-	4	5	46"	3405
9000 or 11,000	Optional	Yes (optional)	Dry bath	Queen-size	Optional	Standard	26"x72"	150	36"x72"	-	-	4	4	48"	2790
9000 or 11,000	Optional	Yes (optional)	Dry bath	Queen-size	Optional	Optional	30"x72"	150	45"x72"	-	-	4	4	49"	2980
9000 or 11,000	Optional	Yes (optional)	Dry bath	Queen-size	Optional	Optional	30"x78"	150	46"x78"	-	-	4	5	57"	3670
9000 or 11,000	Optional	Yes (optional)	Dry bath	Queen-size	Optional	Optional	30"x72"	150	51"x72"	50"x72"	1000	4	7	53"	3705

IMPORT FULL-SIZED SHORT BEDS (NISSAN® TITAN™/TOYOTA® TUNDRA™)



Lance 825
Lance 865

DOMESTIC LIGHT-DUTY F-150/1500 SERIES (OR LARGER) SHORT BEDS



Lance 825
Lance 865

DOMESTIC HEAVY-DUTY F-250/2500 SERIES (OR LARGER) SHORT BEDS



Lance 830
Lance 855
Lance 855S

DOMESTIC HEAVY-DUTY F-250/2500 SERIES (OR LARGER) SINGLE-REAR-WHEEL LONG BEDS



Lance 850
Lance 950
Lance 950S
Lance 992
Lance 1050
Lance 1050S

DOMESTIC F-350/3500 SERIES (OR LARGER) DUAL-REAR-WHEEL LONG BEDS



Lance 850
Lance 950
Lance 950S
Lance 992
Lance 1050
Lance 1050S
Lance 1181
Lance 1191

SHORT BED - MINIMUM SIX-FOOT BED

SHORT BED - MINIMUM SIX-FOOT BED

SHORT BED - MINIMUM SIX-FOOT BED

950 9'11" LONG BED TRUCK



SLIDEOUT VERSION
950S

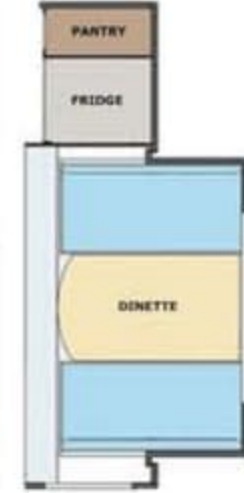

992 9'11" LONG BED TRUCK



1050 10'11" LONG BED TRUCK



SLIDEOUT VERSION
1050S

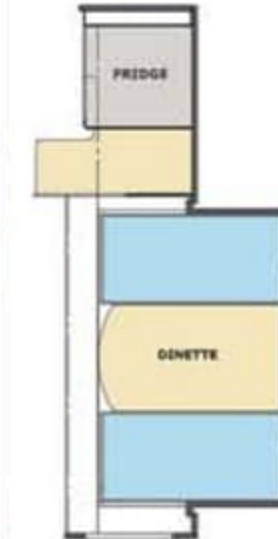

1181 11'6" LONG BED TRUCK



1191 11'6" LONG BED TRUCK

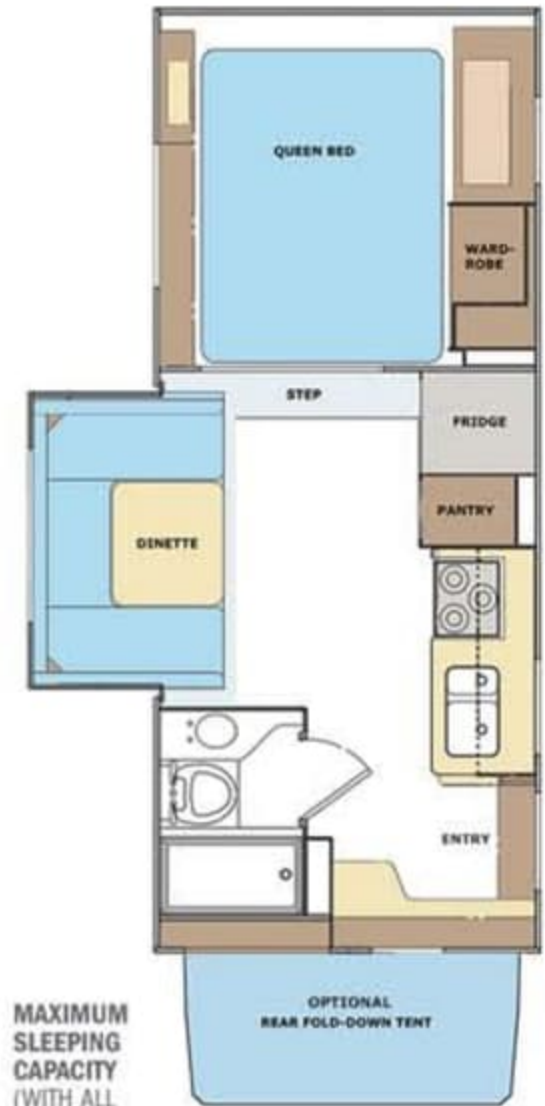

GENERATOR CAPABILITY
(PORTABLE UNITS ARE AN OWNER-SUPPLIED, GASOLINE-POWERED GENERATOR - AND OPTIONAL UNITS ARE A 2500-WATT/120-VOLTS AC, PROPANE-POWERED, CUMMINS ONAN® GENERATOR)

TWO TWIN-SIZE BEDS
CAN REPLACE THE ONE QUEEN-SIZE CABOVER BED - AND WITH EACH TWIN MATTRESS MEASURING 32"x78" - THEIR MATTRESS COVERS CAN BE ZIPPED TOGETHER TO CREATE ONE KING-SIZE CABOVER BED

OPTIONAL AIR CONDITIONER OUTPUT (BTUs)	GENERATOR CAPABILITY	SOLAR PANEL CAPABILITY	SHOWER/TOILET CONFIGURATION	CABOVER BED	FOLD-DOWN BUNK BED	FOLD-DOWN BUNK BED SIZE	FOLD-DOWN BUNK BED WEIGHT RATING (POUNDS)	DINETTE BED SIZE	(OPTIONAL) REAR FOLD-DOWN TENT BED SIZE	(OPTIONAL) REAR FOLD-DOWN TENT BED WEIGHT RATING (POUNDS)	STANDARD SLEEPING CAPACITY (BASE MODEL)	MAXIMUM SLEEPING CAPACITY (WITH ALL BEDDING OPTIONS INCLUDED)	CENTER OF GRAVITY	DRY WEIGHT (POUNDS)	
9000	Portable	Yes (optional)	Wet bath	Queen-size	Optional	Optional	26"x72"	150	36"x72"	-	4	5	33"	1730	
9000 or 11,000	Portable	Yes (optional)	Wet bath	Queen-size	Optional	-	-	-	42"x78"	50"x72"	1000	4	6	35"	2285
9000 or 11,000	Portable	Yes (optional)	Wet bath	Queen-size	Optional	Standard	26"x72"	150	36"x72"	-	5	5	34"	2350	
9000 or 11,000	Optional	Yes (optional)	Wet bath	Queen-size	Optional	Standard	26"x72"	150	36"x72"	-	5	5	36"	2420	
9000 or 11,000	Optional	Yes (optional)	Wet bath	Queen-size	Optional	Optional	30"x72"	150	45"x72"	-	5	5	37"	2620	
9000	Portable	Yes (optional)	Wet bath	Queen-size	Optional	Standard	26"x72"	150	32"x72"	-	5	5	32"	1870	
9000 or 11,000	Optional	Yes (optional)	Wet bath	Queen-size	Optional	Standard	26"x72"	150	36"x72"	-	5	5	47"	2590	
9000 or 11,000	Optional	Yes (optional)	Wet bath	Queen-size	Optional	Optional	30"x72"	150	45"x72"	-	4	5	48"	2800	
9000 or 11,000	Optional	Yes (optional)	Wet bath	Queen-size	Optional	Optional	30"x72"	150	51"x72"	-	4	5	46"	3405	
9000 or 11,000	Optional	Yes (optional)	Dry bath	Queen-size	Optional	Standard	26"x72"	150	36"x72"	-	4	4	48"	2790	
9000 or 11,000	Optional	Yes (optional)	Dry bath	Queen-size	Optional	Optional	30"x72"	150	45"x72"	-	4	4	49"	2980	
9000 or 11,000	Optional	Yes (optional)	Dry bath	Queen-size	Optional	Optional	30"x78"	150	46"x78"	-	4	5	57"	3670	
9000 or 11,000	Optional	Yes (optional)	Dry bath	Queen-size	Optional	Optional	30"x72"	150	51"x72"	50"x72"	1000	7	53"	3705	

IMPORT FULL-SIZED SHORT BEDS
(NISSAN® TITAN™/TOYOTA® TUNDRA™)



Lance **825**
Lance **865**

SHORT BED - MINIMUM SIX-FOOT BED

DOMESTIC LIGHT-DUTY F-150/1500 SERIES
(OR LARGER) SHORT BEDS



Lance **825**
Lance **865**

SHORT BED - MINIMUM SIX-FOOT BED

DOMESTIC HEAVY-DUTY F-250/2500 SERIES
(OR LARGER) SHORT BEDS



Lance **830**
Lance **855**
Lance **855S**

SHORT BED - MINIMUM SIX-FOOT BED

DOMESTIC HEAVY-DUTY F-250/2500 SERIES
(OR LARGER) SINGLE-REAR-WHEEL LONG BEDS



Lance **850** Lance **992**
Lance **950** Lance **1050**
Lance **950S** Lance **1050S**

DOMESTIC F-350/3500 SERIES
(OR LARGER) DUAL-REAR-WHEEL LONG BEDS



Lance **850** Lance **1050**
Lance **950** Lance **1050S**
Lance **950S** Lance **1181**
Lance **992** Lance **1191**

Lance 1191



Red Rock interior

The 1191 is a side-entry model that's excellent for traditional campsite camping or towing.

Add the optional fold-down rear tent (with its foam mattress) and dinette bunk bed, and you can actually sleep up to seven people comfortably. The bath area is excellent, the galley is functionally designed and well-appointed, with lots of storage all around. Since introduced in 2005, many full-time RVers have enjoyed the 1191.

living the
**Lance
life**



SEVERAL YEARS AGO, LANCE OWNER AND EXPLORER BRAD CHRIST toured for 11 months across Central and South America in his Lance 1191 atop a Chevy Kodiak diesel. **"We loved our casa rodante...our 'rolling home'!"**



Lance 1191



Red Rock interior

The 1191 is a side-entry model that's excellent for traditional campsite camping or towing.

Add the optional fold-down rear tent (with its foam mattress) and dinette bunk bed, and you can actually sleep up to seven people comfortably. The bath area is excellent, the galley is functionally designed and well-appointed, with lots of storage all around. Since introduced in 2005, many full-time RVers have enjoyed the 1191.

living the
Lance
life



SEVERAL YEARS AGO, LANCE OWNER AND EXPLORER BRAD CHRIST toured for 11 months across Central and South America in his Lance 1191 atop a Chevy Kodiak diesel. "We loved our *casa rodante*...our 'rolling home'!"



Lance 1181



The 2012 Lance 1181 camper has the most floor space of all Lance campers. Once the full-wall slideout dinette/refrigerator/wardrobe closet is deployed, you'll feel like dancing – and there's room for you to do it. After a dusty trail ride, you'll enjoy the enormous dry bath – where the shower is separate from the toilet area. Then see the cabover's three-quarter-wall hanging wardrobe closet. And taking long items is a snap with large pull-out storage drawer located in the basement.



Rain Forest Interior

Lance 1181



The 2012 Lance 1181 camper has the most floor space of all Lance campers. Once the full-wall slideout dinette/refrigerator/wardrobe closet is deployed, you'll feel like dancing – and there's room for you to do it. After a dusty trail ride, you'll enjoy the enormous dry bath – where the shower is separate from the toilet area. Then see the cabover's three-quarter-wall hanging wardrobe closet. And taking long items is a snap with large pull-out storage drawer located in the basement.



Rain Forest interior

Lance 1050S



The 2012 Lance 1050S is a lightweight, three-quarter-ton series slideout camper with a dry bath that has an enormous amount of countertop space, drawers, hanging wardrobe, efficient kitchen area, and queen-size bed. In all, a great family camper that has a "cook's dream" galley.



Gold Rush interior

Lance 1050S



The 2012 Lance 1050S is a lightweight, three-quarter-ton series slideout camper with a dry bath that has an enormous amount of countertop space, drawers, hanging wardrobe, efficient kitchen area, and queen-size bed. In all, a great family camper that has a "cook's dream" galley.



Gold Rush interior

Lance 992



Gold Rush interior

The 2012 Lance 992 is a double-slideout model that has the feel of a much larger camper. The kitchen is fully functional either with the galley slideout retracted or deployed. Counter space is abundant in the 992, and there's ample storage throughout, too. The wet bath design is deceiving - as it actually has more cubic space for a shower than any other camper Lance builds.

living the
Lance
life



ALREADY ENJOYING THEIR SECOND LANCE CAMPER, RUSS AND DONNA MILLER are the "Take Two Variety Band" - professional, traveling musicians that entertain audiences at both outdoor and indoor events - towing their stage trailer with them. "Our Lance truck camper is convenient for us, especially when we need to freshen-up and change our clothes before we go on stage. Of course, it provides our accommodations while at the venue."



Lance 992



Gold Rush interior

The 2012 Lance 992 is a double-slideout model that has the feel of a much larger camper. The kitchen is fully functional either with the galley slideout retracted or deployed. Counter space is abundant in the 992, and there's ample storage throughout, too. The wet bath design is deceiving - as it actually has more cubic space for a shower than any other camper Lance builds.

living the **Lance life**



ALREADY ENJOYING THEIR SECOND LANCE CAMPER, RUSS AND DONNA MILLER are the "Take Two Variety Band" - professional, traveling musicians that entertain audiences at both outdoor and indoor events - towing their stage trailer with them. "Our Lance truck camper is convenient for us, especially when we need to freshen-up and change our clothes before we go on stage. Of course, it provides our accommodations while at the venue."



Lance 855S



Gold Rush interior

The Lance 855S is a great floorplan featuring a large dinette that converts to a man-sized bed.



With a generous size bath, a full queen cabover bed and complete galley, you'll marvel in how we built-in so many terrific amenities in a short bed camper that's less than nine feet.



Lance 830



When you're in need of two separate sleeping areas and lots of storage, then the new 2012 Lance 830 is ideal for short bed trucks (which have a minimum bed size of six feet). Built with a European feel and Lance flair for



The dinette table slides



versatility, this camper will transform into a chef's dream galley with

Lance 855S



Gold Rush interior

The Lance 855S is a great floorplan featuring a large dinette that converts to a man-sized bed.



With a generous size bath, a full queen cabover bed and complete galley, you'll marvel in how we built-in so many terrific amenities in a short bed camper that's less than nine feet.



Lance 830



The dinette table slides

When you're in need of two separate sleeping areas and lots of storage, then the new 2012 Lance 830 is ideal for short bed trucks (which have a minimum bed size of six feet). Built with a European feel and Lance flair for



versatility, this camper will transform into a chef's dream galley with

Lance 825



Red Rock interior



Rain Forest interior



over for extra space, or as a galley counter.

extra counter space or a comfortable area to view a movie or watch TV. Storage is always key to choosing the perfect camper. And on a grading scale, we think you'll give the Lance 830 an A+.



This high-quality camper has everything needed to enjoy the outdoors at a modest price - with less weight.



The 2012 Lance 825 is light enough to fit on a Toyota® Tundra®, Nissan® Titan®, or F-150/1500 series short bed (a truck bed with a minimum of six feet). When the weekend calls, you can relax and have fun in your new Lance 825.

Lance 825



Red Rock interior



Rain Forest interior



This high-quality camper has everything needed to enjoy the outdoors at a modest price - with less weight.



over for extra space, or as a galley counter.

extra counter space or a comfortable area to view a movie or watch TV. Storage is always key to choosing the perfect camper. And on a grading scale, we think you'll give the Lance 830 an A+.



The 2012 Lance 825 is light enough to fit on a Toyota® Tundra™, Nissan® Titan™, or F-150/1500 series short bed (a truck bed with a minimum of six feet). When the weekend calls, you can relax and have fun in your new Lance 825.



Four-Season Certified

The six options below comprise the Four-Season Package - which qualifies your camper for the Four-Season Certified badge - features that will assure you the fun of all-weather recreation:

- Radius tinted insulated dual-pane windows.
- Water heater bypass and winterizing valve.
- Insulated cabover bed pad.
- Insulated hatch covers.
- Dual 15,000/22,000-BTU furnace.
- Insulated battery and propane compartments.

THE 2012 LANCE TRUCK CAMPER BROCHURE. ©2011 Lance Camper Manufacturing Corporation (LCMC). All rights reserved. Lance, the Lance logomark, the Lance logomark with chevron, America's Favorite Truck Camper, RV: Recreational Versatility, The Most Versatile RVs On The Planet, America's Favorite Campers - Earth's Most Versatile RVs, The Lance Look, Lance Custom Design, Bed-Maid, LanceLock, Living The Lance Life, SportsCamper and other exclusive Lance product names, marks or designations are trademarks, service marks or registered trademarks of LCMC. All other marks are property of their respective owners. **All product data, graphics and photography in this book were as accurate as possible at press time. Subsequent refinements during the model year may be evident in the actual product. LCMC reserves the right to change prices, colors, materials, equipment and specifications without notice - as well as to add, modify or discontinue models shown in promotional materials and/or on its websites.** All weights, fuel and liquid capacities are approximate and dimensions are nominal. LCMC has designed its truck campers to provide a variety of potential uses for owners. Each model features optimum living, storage, fluid, seating and sleeping capacities. Though each owner enjoys this potential, ultimately, it's that purchaser's sole responsibility to select the proper Lance camper model and support equipment appropriate to their truck without exceeding safe weight operating capacities. Your Factory Authorized Lance Dealer can advise you of the operating parameters for your particular situation, and can confirm prices and product specifications material to your purchase decision. This book was designed and produced entirely in-house by LCMC's Creative Director/Sales + Marketing. Web litho in USA on Sterling® Ultra. CS/0911/60M

	825	830	850	855	855S	865	950	950S	992	1050	1050S	1181	1191
FRESH + WASTE WATER SYSTEMS													
Water pump with in-line filter	S	S	S	S	S	S	S	S	S	S	S	S	S
Six-gallon DSI (direct spark ignition) water heater	S	S	S	S	S	S	S	S	S	S	S	S	S
Propane/electric DSI water heater (option 320)	0	0	0	0	0	0	0	0	0	0	0	0	0
Water heater bypass and winterizing valve (option 700)	0	0	0	0	0	0	0	0	0	0	0	0	0
Enclosed, insulated and heated holding tanks	S	S	S	S	S	S	S	S	S	S	S	S	S
BATHROOM													
Cassette toilet (option 570)	0	0											
Toilet tank flush (option 550)	0	0	0	0	0	0	0	0	0	0	0	0	0
Medicine cabinet with mirror door		S	S	S	S	S	S	S	S	S	S	S	S
Storage cabinet													S
Mirror on bath door			S	S	S	S	S	S	S	S	S	S	S
Sliding bath door	S		S	S	S	S	S	S	S	S	S	S	S
Curved sliding bath door		S											
Towel rod	S	S	S	S	S	S	S	S	S	S	S	S	S
Dual-pane skylight	S	S	S	S	S	S	S	S	S	S	S	S	S
Ducted heat outlet	S	S	S	S	S	S	S	S	S	S	S	S	S
Removable clothes rod (option 230)	0		0	0	0	0	0	0	0	0	0	0	0
DINETTE													
Dinette with reversible cushions	S	S	S	S	S	S	S	S	S	S	S	S	S
"Super-slideout" U-shaped dinette									S			S	S
Rollout storage drawer in dinette (option 200)					0			0	0		0	0	0
Dinette overhead cabinet		S											
Overhead cabinet bunk (option 109)	0		S	S		S	S			S			
Bunk bed with child restraint (option 110)					0			0	0		0	0	0
Child restraint with bunk pad (option 111)	0		0	0		0	0			0			
Cargo net (option 112)	0		0	0		0	0			0			
CABOVER + SLEEPING ACCOMMODATIONS													
Cabover twin beds (option 102)	0	0	0	0	0	0	0	0	0	0	0	0	0
Deluxe queen innerspring mattress with pillow top	S	S	S	S	S	S	S	S	S	S	S	S	S
Bedspring	S	S	S	S	S	S	S	S	S	S	S	S	S
Headboard		S	S	S	S		S	S	S	S	S	S	S
Lance Bed-Maid™ sleep system (option 116)	0	0	0	0	0	0	0	0	0	0	0	0	0
Cabover reading lights	S	S	S	S	S	S	S	S	S	S	S	S	S
Side overhead open wire shelves	S	S	S	S	S	S	S	S		S	S		
Cabover privacy curtain	S	S	S	S	S	S	S	S	S	S	S	S	S
Cabover folding privacy door (option 132)										0		0	0
Ducted heat outlet in cabover			S	S	S		S	S	S	S	S	S	S
Carpeted cabover bed	S	S	S	S	S	S	S	S	S	S	S	S	S
Insulated bed pad (option 725)	0	0	0	0	0	0	0	0	0	0	0	0	0
Mirrored wardrobe cabinet with window in curbside cabover									S			S	S

	825	830	850	855	855S	865	950	950S	992	1050	1050S	1181	1191
ELECTRICAL													
Systems monitor panel	S	S	S	S	S	S	S	S	S	S	S	S	S
LED battery condition indicator	S	S	S	S	S	S	S	S	S	S	S	S	S
Single battery compartment	S	S	S	S	S	S	S	S		S	S		
Second battery compartment (option 556)		0	0	0	0		0	0	S	0	0	S	S
Manual push-pull battery disconnect	S	S	S	S	S	S	S	S	S	S	S	S	S
Battery separator (option 555)	0	0	0	0	0	0	0	0	0	0	0	0	0
Fluorescent lighting (single fixture)		S	S	S	S		S	S		S	S		
Fluorescent lighting (two fixtures)									S			S	S
Incandescent lighting	S	S	S	S	S	S	S	S	S	S	S	S	S
Wall switched lighting									S			S	S
Ceiling and overhead LED lighting					S			S	S		S	S	S
Wardrobe light (option 225)	0	0	0	0	0	0	0	0	0	0	0	0	0
12-volt DC outlet in dinette (option 226)	0	0	0	0	0	0	0	0	0	0	0	0	0
Pre-wired for roof air conditioner	S	S	S	S	S	S	S	S	S	S	S	S	S
Low-profile Coleman® 9000-BTU air conditioner with ceiling control (option 386)	0	0	0	0	0	0	0	0	0	0	0	0	0
Coleman® 11,000-BTU air conditioner with wall control (option 389)	0	0	0	0			0	0	0	0	0	0	0
Pre-wired for wall thermostat		S	S	S	S		S	S	S	S	S	S	S
Pre-wired for Fan-Tastic® roof vent	S	S	S	S	S	S	S	S	S	S	S	S	S
Fan-Tastic® roof vent (option 370)	0	0	0	0	0	0	0	0	0	0	0	0	0
Power roof vent in bathroom (option 374)	0	0	0	0	0	0	0	0	S	0	0	S	S
Pre-wired for TV antenna, satellite dish and park cable	S	S	S	S	S	S	S	S	S	S	S	S	S
High definition TV antenna (option 352)	0	0	0	0	0	0	0	0	0	0	0	0	0
Satellite dish (option 360)	0	0	0	0	0	0	0	0	0	0	0	0	0
Self-locating satellite dish (option 362)	0	0	0	0	0	0	0	0	0	0	0	0	0
AM/FM/DVD/CD stereo with iPod® hookup and interior/exterior speakers and antenna	S	S	S	S	S	S	S	S	S	S	S	S	S
19-inch TV (option 342)	0	0	0	0	0	0	0	0	0	0	0	0	0
Pre-wired for solar panel	S	S	S	S	S	S	S	S	S	S	S	S	S
Solar panel (option 510)	0	0	0	0	0	0	0	0	0	0	0	0	0
Switched patio light	S	S	S	S	S	S	S	S	S	S	S	S	S
Side patio lights (option 530)	0	0	0	0	0	0	0	0	0	0	0	0	0
Docking lights (option 532)	0	0	0	0	0	0	0	0	0	0	0	0	0
Wireless remote slideout control					S			S	S		S	S	S
Exterior 110-volt AC patio outlet	S	S	S	S	S	S	S	S	S	S	S	S	S
Generator ready					S	S		S	S	S	S	S	S
Generator (option 330)					0	0		0	0	0	0	0	0
Backup camera (option 528)	0	0	0	0	0	0	0	0	0	0	0	0	0
SAFETY EQUIPMENT													
Propane leak and carbon monoxide detector	S	S	S	S	S	S	S	S	S	S	S	S	S
Smoke detector	S	S	S	S	S	S	S	S	S	S	S	S	S
Fire extinguisher	S	S	S	S	S	S	S	S	S	S	S	S	S

Lance warranty Lance provides a limited warranty to the original owner (purchaser) of a new 2012 Lance truck camper to be free of defects in materials, workmanship and structural integrity (under normal use with reasonable care and routine prescribed maintenance) for a period of one year from the date of purchase - subject to exclusions for vendor-made parts and components.



Four-Season Certified

The six options below comprise the Four-Season Package – which qualifies your camper for the Four-Season Certified badge – features that will assure you the fun of all-weather recreation:

- Radius tinted insulated dual-pane windows.
- Water heater bypass and winterizing valve.
- Insulated cabover bed pad.
- Insulated hatch covers.
- Dual 15,000/22,000-BTU furnace.
- Insulated battery and propane compartments.

THE 2012 LANCE TRUCK CAMPER BROCHURE. ©2011 Lance Camper Manufacturing Corporation (LCMC). All rights reserved. Lance, the Lance logomark, the Lance logomark with chevron, America's Favorite Truck Camper, RV: Recreational Versatility, The Most Versatile RVs On The Planet, America's Favorite Campers – Earth's Most Versatile RVs, The Lance Look, Lance Custom Design, Bed-Maid, LanceLock, Living The Lance Life, SportsCamper and other exclusive Lance product names, marks or designations are trademarks, service marks or registered trademarks of LCMC. All other marks are property of their respective owners. **All product data, graphics and photography in this book were as accurate as possible at press time. Subsequent refinements during the model year may be evident in the actual product. LCMC reserves the right to change prices, colors, materials, equipment and specifications without notice – as well as to add, modify or discontinue models shown in promotional materials and/or on its websites.** All weights, fuel and liquid capacities are approximate and dimensions are nominal. LCMC has designed its truck campers to provide a variety of potential users for owners. Each model features optimum living, storage, fluid, seating and sleeping capacities. Though each owner enjoys this potential, ultimately, it's that purchaser's sole responsibility to select the proper Lance camper model and support equipment appropriate to their truck without exceeding safe weight operating capacities. Your Factory Authorized Lance Dealer can advise you of the operating parameters for your particular situation, and can confirm prices and product specifications material to your purchase decision. This book was designed and produced entirely in-house by LCMC's Creative Director/Sales + Marketing. Web litho in USA on Sterling® Ultra. CS/0911/60M

	825	830	850	855	855S	865	950	950S	992	1050	1050S	1181	1191
FRESH + WASTE WATER SYSTEMS													
Water pump with in-line filter	S	S	S	S	S	S	S	S	S	S	S	S	S
Six-gallon DSI (direct spark ignition) water heater	S	S	S	S	S	S	S	S	S	S	S	S	S
Propane/electric DSI water heater (option 320)	0	0	0	0	0	0	0	0	0	0	0	0	0
Water heater bypass and winterizing valve (option 700)	0	0	0	0	0	0	0	0	0	0	0	0	0
Enclosed, insulated and heated holding tanks	S	S	S	S	S	S	S	S	S	S	S	S	S
BATHROOM													
Cassette toilet (option 570)	0	0											
Toilet tank flush (option 550)	0	0	0	0	0	0	0	0	0	0	0	0	0
Medicine cabinet with mirror door		S	S	S	S	S	S	S	S	S	S	S	S
Storage cabinet												S	
Mirror on bath door			S	S	S	S	S	S	S	S	S	S	S
Sliding bath door	S		S	S	S	S	S	S	S	S	S	S	S
Curved sliding bath door		S											
Towel rod	S	S	S	S	S	S	S	S	S	S	S	S	S
Dual-pane skylight	S	S	S	S	S	S	S	S	S	S	S	S	S
Ducted heat outlet	S	S	S	S	S	S	S	S	S	S	S	S	S
Removable clothes rod (option 230)	0		0	0	0	0	0	0	0	0	0	0	0
DINETTE													
Dinette with reversible cushions	S	S	S	S	S	S	S	S	S	S	S	S	S
"Super-slideout" U-shaped dinette									S			S	S
Rollout storage drawer in dinette (option 200)					0			0	0		0	0	0
Dinette overhead cabinet		S											
Overhead cabinet bunk (option 109)	0		S	S		S	S			S			
Bunk bed with child restraint (option 110)					0			0	0		0	0	0
Child restraint with bunk pad (option 111)	0		0	0		0	0			0			
Cargo net (option 112)	0		0	0		0	0			0			
CABOVER + SLEEPING ACCOMMODATIONS													
Cabover twin beds (option 102)	0	0	0	0	0	0	0	0	0	0	0	0	0
Deluxe queen innerspring mattress with pillow top	S	S	S	S	S	S	S	S	S	S	S	S	S
Bedspring	S	S	S	S	S	S	S	S	S	S	S	S	S
Headboard		S	S	S	S		S	S	S	S	S	S	S
Lance Bed-Maid™ sleep system (option 116)	0	0	0	0	0	0	0	0	0	0	0	0	0
Cabover reading lights	S	S	S	S	S	S	S	S	S	S	S	S	S
Side overhead open wire shelves	S	S	S	S	S	S	S	S		S	S		
Cabover privacy curtain	S	S	S	S	S	S	S	S	S	S	S	S	S
Cabover folding privacy door (option 132)									0			0	0
Ducted heat outlet in cabover			S	S	S		S	S	S	S	S	S	S
Carpeted cabover bed	S	S	S	S	S	S	S	S	S	S	S	S	S
Insulated bed pad (option 725)	0	0	0	0	0	0	0	0	0	0	0	0	0
Mirrored wardrobe cabinet with window in curbside cabover									S			S	S

	825	830	850	855	855S	865	950	950S	992	1050	1050S	1181	1191
ELECTRICAL													
Systems monitor panel	S	S	S	S	S	S	S	S	S	S	S	S	S
LED battery condition indicator	S	S	S	S	S	S	S	S	S	S	S	S	S
Single battery compartment	S	S	S	S	S	S	S	S		S	S		
Second battery compartment (option 556)		0	0	0	0		0	0	S	0	0	S	S
Manual push-pull battery disconnect	S	S	S	S	S	S	S	S	S	S	S	S	S
Battery separator (option 555)	0	0	0	0	0	0	0	0	0	0	0	0	0
Fluorescent lighting (single fixture)		S	S	S	S		S	S		S	S		
Fluorescent lighting (two fixtures)									S			S	S
Incandescent lighting	S	S	S	S	S	S	S	S	S	S	S	S	S
Wall switched lighting									S			S	S
Ceiling and overhead LED lighting					S			S	S		S	S	S
Wardrobe light (option 225)	0	0	0	0	0	0	0	0	0	0	0	0	0
12-volt DC outlet in dinette (option 226)	0	0	0	0	0	0	0	0	0	0	0	0	0
Pre-wired for roof air conditioner	S	S	S	S	S	S	S	S	S	S	S	S	S
Low-profile Coleman® 9000-BTU air conditioner with ceiling control (option 386)	0	0	0	0	0	0	0	0	0	0	0	0	0
Coleman® 11,000-BTU air conditioner with wall control (option 389)		0	0	0	0		0	0	0	0	0	0	0
Pre-wired for wall thermostat		S	S	S	S		S	S	S	S	S	S	S
Pre-wired for Fan-Tastic® roof vent	S	S	S	S	S	S	S	S	S	S	S	S	S
Fan-Tastic® roof vent (option 370)	0	0	0	0	0	0	0	0	0	0	0	0	0
Power roof vent in bathroom (option 374)	0	0	0	0	0	0	0	0	0	S	0	0	S
Pre-wired for TV antenna, satellite dish and park cable	S	S	S	S	S	S	S	S	S	S	S	S	S
High definition TV antenna (option 352)	0	0	0	0	0	0	0	0	0	0	0	0	0
Satellite dish (option 360)	0	0	0	0	0	0	0	0	0	0	0	0	0
Self-locating satellite dish (option 362)	0	0	0	0	0	0	0	0	0	0	0	0	0
AM/FM/DVD/CD stereo with iPod® hookup and interior/exterior speakers and antenna	S	S	S	S	S	S	S	S	S	S	S	S	S
19-inch TV (option 342)	0	0	0	0	0	0	0	0	0	0	0	0	0
Pre-wired for solar panel	S	S	S	S	S	S	S	S	S	S	S	S	S
Solar panel (option 510)	0	0	0	0	0	0	0	0	0	0	0	0	0
Switched patio light	S	S	S	S	S	S	S	S	S	S	S	S	S
Side patio lights (option 530)	0	0	0	0	0	0	0	0	0	0	0	0	0
Docking lights (option 532)	0	0	0	0	0	0	0	0	0	0	0	0	0
Wireless remote slideout control					S			S	S		S	S	S
Exterior 110-volt AC patio outlet	S	S	S	S	S	S	S	S	S	S	S	S	S
Generator ready					S	S		S	S	S	S	S	S
Generator (option 330)					0	0		0	0	0	0	0	0
Backup camera (option 528)	0	0	0	0	0	0	0	0	0	0	0	0	0
SAFETY EQUIPMENT													
Propane leak and carbon monoxide detector	S	S	S	S	S	S	S	S	S	S	S	S	S
Smoke detector	S	S	S	S	S	S	S	S	S	S	S	S	S
Fire extinguisher	S	S	S	S	S	S	S	S	S	S	S	S	S

Lance warranty Lance provides a limited warranty to the original owner (purchaser) of a new 2012 Lance truck camper to be free of defects in materials, workmanship and structural integrity (under normal use with reasonable care and routine prescribed maintenance) for a period of one year from the date of purchase – subject to exclusions for vendor-made parts and components.

LanceLock

design + construction

LanceLock™ is the exclusive process we design and construct *all* our RVs for strength and durability - using interlocking aluminum framing, laminated panels, and structural cabinetry.



LanceLock Phase I

ENGINEERING + DESIGN

Interlocking structural
Lite-Ply® cabinetry

the LanceLock process

- 1 Computer-aided designs are generated in Product Development.
- 2 Computer numerical control (CNC) machines cut and rout structural panels to ensure uniformity and tight-tolerance fit.
- 3 Imported from Europe, Lite-Ply® interlocking solid wood cabinetry provides sturdy structural integrity, and lasting durability and beauty.
- 4 Fingertip-positive latches on cabinetry prevent contents from spilling out.
- 5 Full-extension drawer slides use metal rails and ball bearings.
- 6 Structural panels are laminated under intense pressure using special heat-set adhesives.
- 7 .062-inch-thickness aluminum tubing (coated with Alodine® to help protect against corrosion) is welded into incredibly strong framing.
- 8 Solid block foam offers four-season insulation.

LanceLock

design + construction

LanceLock™ is the exclusive process we design and construct *all* our RVs for strength and durability - using interlocking aluminum framing, laminated panels, and structural cabinetry.



LanceLock Phase I

ENGINEERING + DESIGN

Interlocking structural
Lite-Ply® cabinetry

the LanceLock™ process

1 Computer-aided designs are generated in Product Development. **2** Computer numerical control (CNC) machines cut and rout structural panels to ensure uniformity and tight-tolerance fit. **3** Imported from Europe, Lite-Ply® interlocking solid wood cabinetry provides sturdy structural integrity, and lasting durability and beauty. **4** Fingertip-positive latches on cabinetry prevent contents from spilling out. **5** Full-extension drawer slides use metal rails and ball bearings. **6** Structural panels are laminated under intense pressure using special heat-set adhesives. **7** .062-inch-thickness aluminum tubing (coated with Alodine® to help protect against corrosion) is welded into incredibly strong framing. **8** Solid block foam offers four-season insulation.

LanceLock Phase II

FABRICATION + ASSEMBLY

Interlocking welded aluminum framing and laminated panels

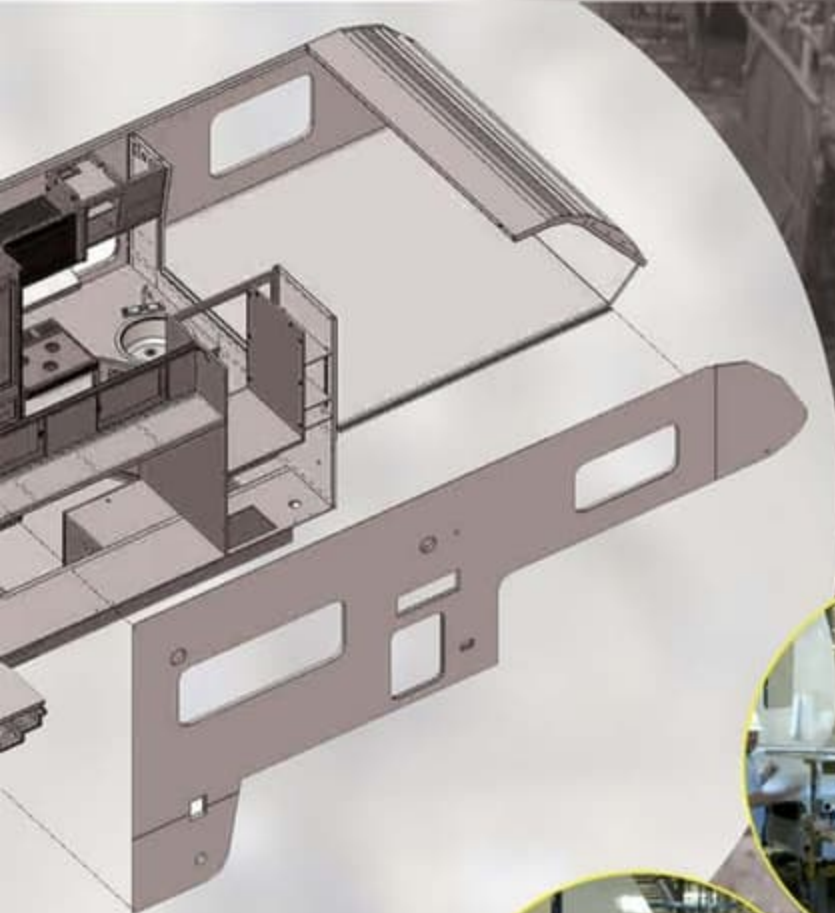

LanceLock Phase III

EXTERIOR SEALS, FINISH + FINAL INSPECTION



9 Interlocking metal beams transition wings to risers in the wall construction. 10 Sub-floor basement areas and sewer valves are heated to prevent freezing. 11 Sidewalls are hung and secured within the LanceLock construction process. 12 The cabover section uses an interlocking extrusion to fit the floor in a tongue-in-groove fashion. 13 Electrical wiring is protected by tubing and wire grommets. 14 Steel tie-down brackets. 15 Roof vents use no screws to prevent water intrusion. 16 Jack mounts are bolted through steel plate hardware fastened on both the inside and outside of the coach. 17 Costly stainless steel and Everlube®-coated fasteners resist corrosion. 18 Lance's double-sealants protect your investment. 19 A sewer hose tray within the aluminum bumper.

The Lance factory – a custom-designed, 141,000-square-foot, state-of-the-art RV manufacturing facility.



LanceLock Phase II

FABRICATION + ASSEMBLY

Interlocking welded aluminum framing and laminated panels

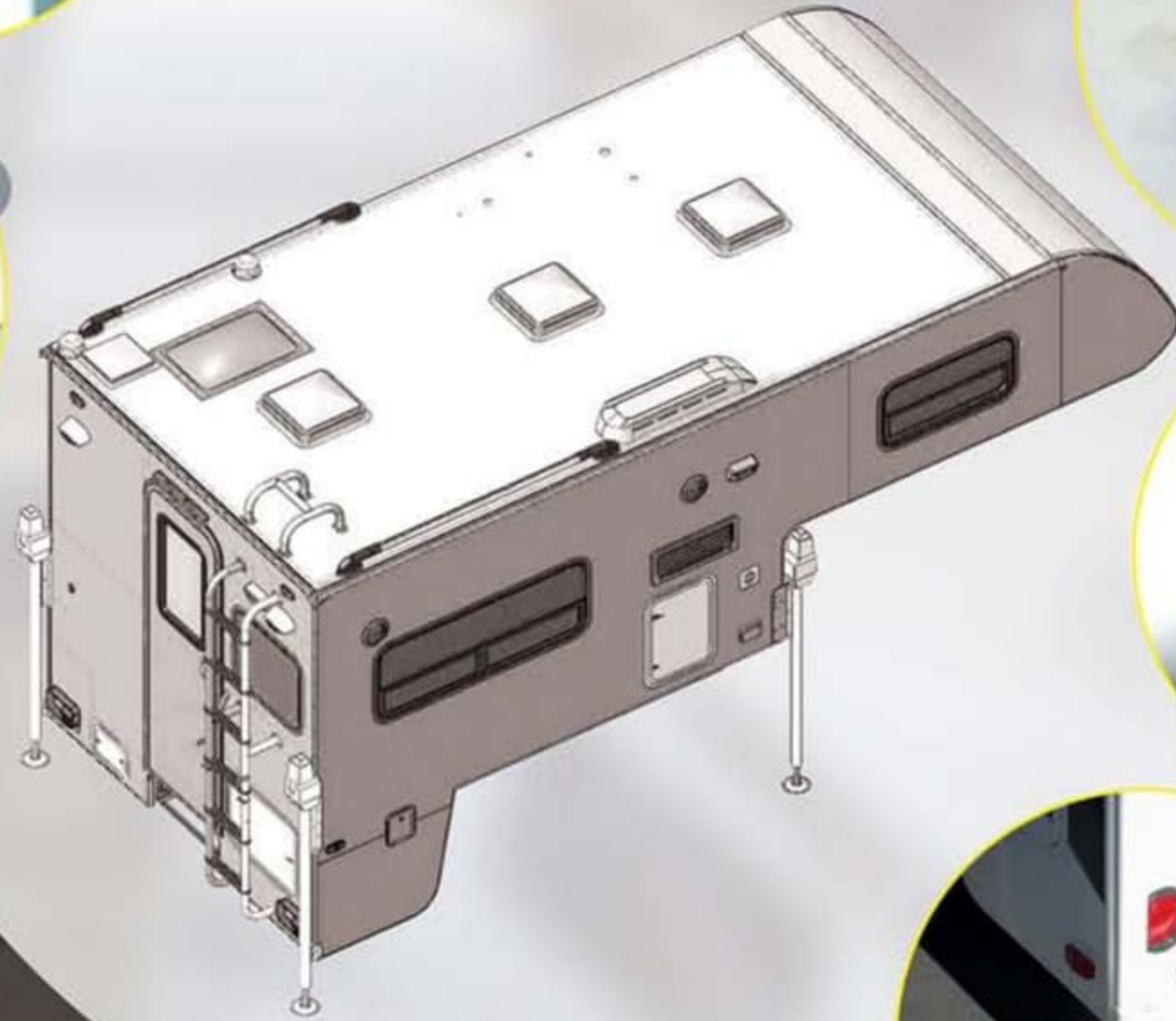
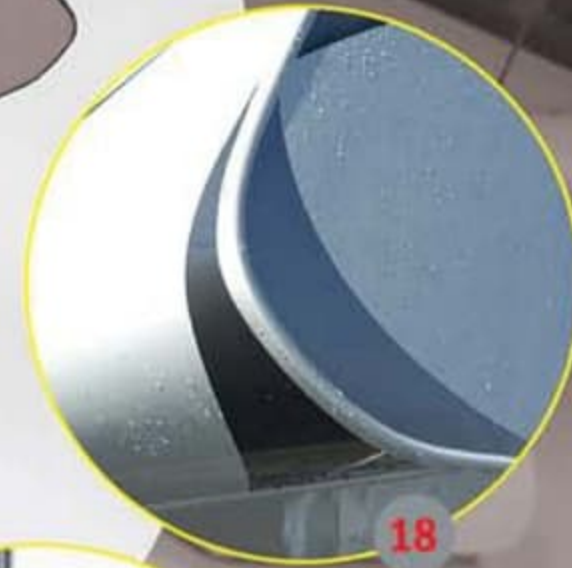
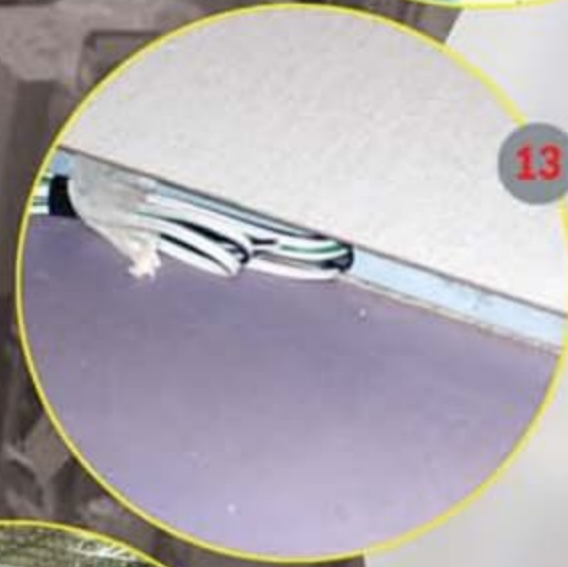
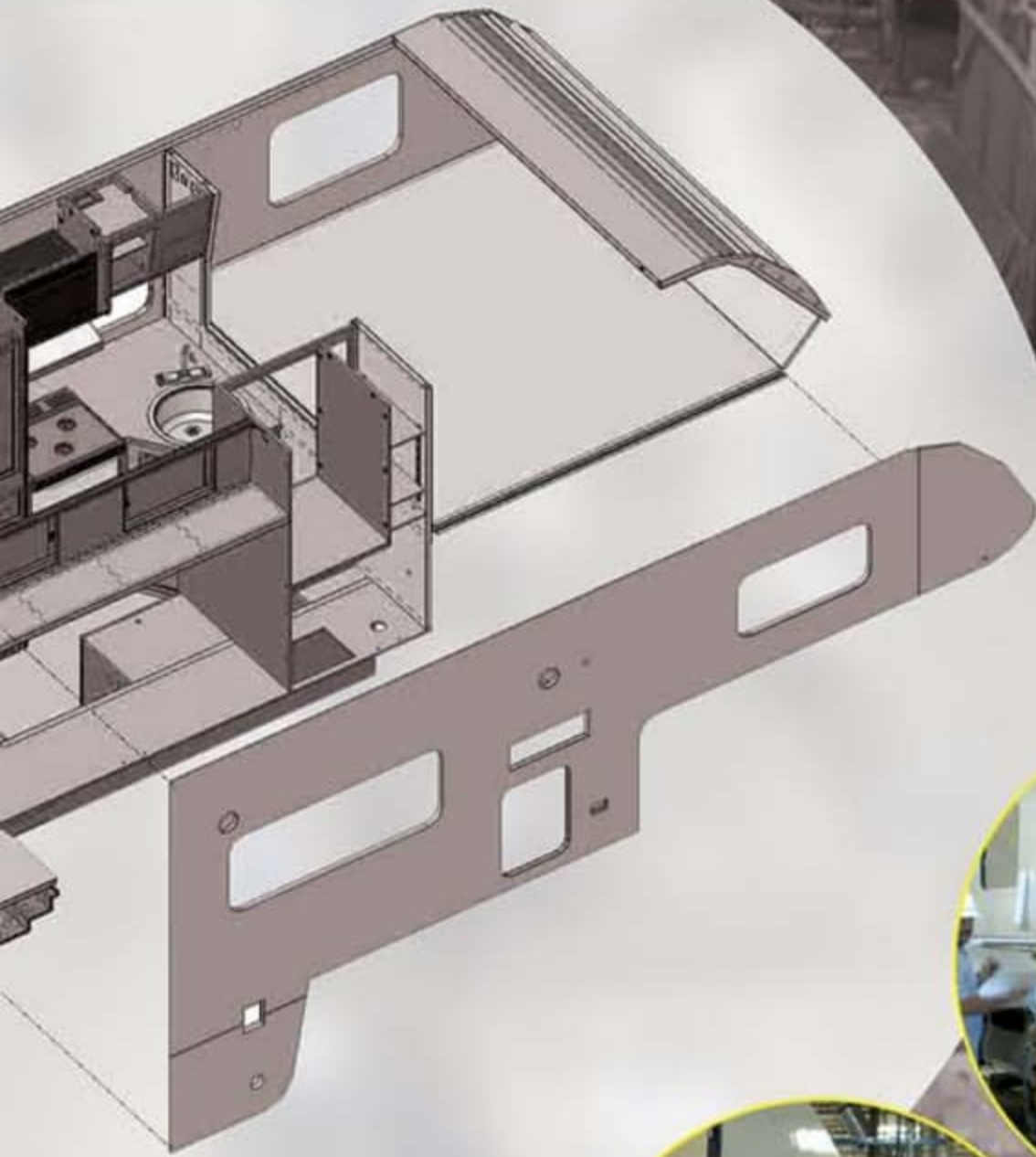

LanceLock Phase III

EXTERIOR SEALS, FINISH + FINAL INSPECTION



9 Interlocking metal beams transition wings to risers in the wall construction. **10** Sub-floor basement areas and sewer valves are heated to prevent freezing. **11** Sidewalls are hung and secured within the LanceLock construction process. **12** The cabover

section uses an interlocking extrusion to fit the floor in a tongue-in-groove fashion. **13** Electrical wiring is protected by tubing and wire grommets. **14** Steel tie-down brackets. **15** Roof vents use no screws to prevent water intrusion. **16** Jack mounts are bolted through steel plate hardware fastened on both the inside and outside of the coach. **17** Costly stainless steel and Everlube®-coated fasteners resist corrosion. **18** Lance's double-sealants protect your investment. **19** A sewer hose tray within the aluminum bumper.

The Lance factory – a custom-designed, 141,000-square-foot, state-of-the-art RV manufacturing facility.



selected optional features + highlights

REMOVABLE CLOTHES ROD IN BATH

Maximize your hanging space or drip-dry bathing suits or rain jackets - with all the water draining into a tank.



50-WATT HALOGEN DOCKING LIGHTS activate when you're in reverse, or can be turned-on manually to light the rear area of your camper at night.



SLIDE-OUT PANTRY | Full-extension slide mechanism allows easy access to stored goods. Adjustable baskets helps in packing and use of space.

DUAL-BTU FURNACE | Lance is the only camper to have this quiet running furnace that burns less fuel - with the ability to automatically rev-up when the weather's really cold outside.



BATTERY SEPARATOR allows your truck's alternator to charge the camper's batteries while the truck is running - without draining the truck's batteries.

TANK FLUSH cleans your black tank without a mess. Simple hose hookup with a built-in sprayer.



REAR FOLD-DOWN TENT BED

A unique option that provides sleeping for two additional people. Easy operation.



TWIN BEDS provide separate sleeping accommodations. By removing the center nightstand you can have a king bed by putting the twins together.



CARGO NET | Drop the bunk while traveling and install a cargo net to double your storage space while keeping your items in their place.



GENERATOR
Power-up the fun of your outings with a propane-powered, 2500-watt AC Cummins Onan electric generator.



ROLLOUT STORAGE is particularly convenient for water and beverages - and heavy and bulky items.



HEKI® SKYLIGHT VENT is a unique dual-pane skylight with a built-in screen and privacy shade - allowing for ventilation and natural light.



A **SOLAR PANEL** will help keep your batteries charged when you dry-camp for days, weeks - or even months!



BACK-UP CAMERA | So you can see what's behind you. This camera is helpful for loading and unloading your camper - as well as during driving.



DUAL-PANE GLASS WINDOWS are optional on all campers (except the 830) and provide additional comfort by adding to the insulation value.



INSULATED HATCH COVERS can be easily snapped onto roof hatches and vents to keep summer heat and winter cold out.



IPOD® HOOKUP | Music can be fed directly to all a camper's interior or exterior speakers using your iPod device.



ROOF RACK SYSTEM

Increase your storage capacity with optional rack system components.



EXTERIOR PROPANE CONNECTOR
Using your stored propane to use low-pressure propane equipment can be done quickly and safely.



WITH 148 LESS ROOF HOLES in our campers (by using vent clamps), we eliminate unnecessary screw holes - which help protect your RV investment.

selected optional features + highlights

REMOVABLE CLOTHES ROD IN BATH

Maximize your hanging space or drip-dry bathing suits or rain jackets – with all the water draining into a tank.



50-WATT HALOGEN DOCKING LIGHTS

activate when you're in reverse, or can be turned-on manually to light the rear area of your camper at night.



SLIDE-OUT PANTRY | Full-extension slide mechanism allows easy access to stored goods. Adjustable baskets helps in packing and use of space.



DUAL-BTU FURNACE | Lance is the only camper to have this quiet running furnace that burns less fuel – with the ability to automatically rev-up when the weather's really cold outside.



BATTERY SEPARATOR allows your truck's alternator to charge the camper's batteries while the truck is running – without draining the truck's batteries.

TANK FLUSH cleans your black tank without a mess. Simple hose hookup with a built-in sprayer.



REAR FOLD-DOWN TENT BED

A unique option that provides sleeping for two additional people. Easy operation.



TWIN BEDS provide separate sleeping accommodations. By removing the center nightstand you can have a king bed by putting the twins together.



CARGO NET | Drop the bunk while traveling and install a cargo net to double your storage space while keeping your items in their place.



GENERATOR
Power-up the fun of your outings with a propane-powered, 2500-watt AC Cummins Onan electric generator.



ROLLOUT STORAGE is particularly convenient for water and beverages – and heavy and bulky items.



HEKI® SKYLIGHT VENT is a unique dual-pane skylight with a built-in screen and privacy shade – allowing for ventilation and natural light.



A **SOLAR PANEL** will help keep your batteries charged when you dry-camp for days, weeks – or even months!



BACK-UP CAMERA | So you can see what's behind you. This camera is helpful for loading and unloading your camper – as well as during driving.

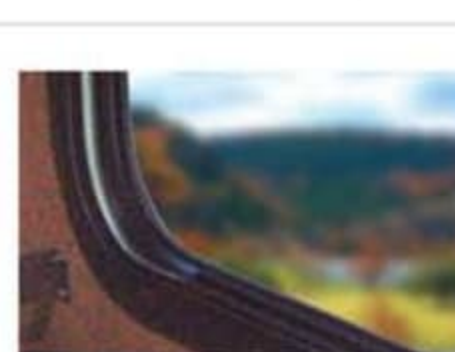

DUAL-PANE GLASS WINDOWS are optional on all campers (except the 830) and provide additional comfort by adding to the insulation value.



INSULATED HATCH COVERS can be easily snapped onto roof hatches and vents to keep summer heat and winter cold out.



IPOD® HOOKUP | Music can be fed directly to all a camper's interior or exterior speakers using your iPod device.

ROOF RACK SYSTEM

Increase your storage capacity with optional rack system components.



EXTERIOR PROPANE CONNECTOR
Using your stored propane to use low-pressure propane equipment can be done quickly and safely.



WITH 148 LESS ROOF HOLES in our campers (by using vent clamps), we eliminate unnecessary screw holes – which help protect your RV investment.



dealer-installed support equipment



4

Happijac Qwik-Load turnbuckle upgrades make anchoring your camper a snap.



8

Lance-exclusive cabover shocks ("cabover struts") have quick-release stainless steel connectors.



2

Wireless rear-view camera/monitor maximizes safety.



REESE
CERTIFIED

Lance recommends Reese towing products.



When not towing loads that require an extended hitch, included in Reese's Tow Beast system is a **reducer sleeve**, which you use to reconnect the hitch ball and draw bar to the receiver hitch.

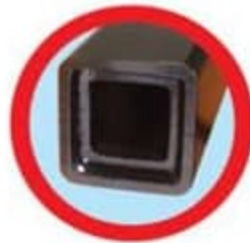

The 48-inch Reese Tow Beast Class V hitch box extension ("tow bar") is constructed with a heavy steel tube inside another steel tube - welded together - to dramatically increase strength and towing capacity.



5

Within Air Lift's Super Duty air springs ("air bags") are the Lance-exclusive internal jounce bumpers - which gradually cushion the suspension of the air springs as they approach the end of their jounce travel.

Installation of these support equipment systems by your Factory Authorized Lance Dealer is highly recommended to ensure you receive "The Ultimate Ride." Experience a dramatic improvement in the drivability and handling of your truck and camper rig - in any weather, on any road.

- 1 Reese® Tow Beast™ Class V hitch/extension system increases your towing capabilities over your truck's factory-stock hitch.
- 2 Wireless rear-view camera/microphone and seven-inch in-cab LCD monitor lets you see - and hear - what's behind you.
- 3 Happijac® frame-mount anchoring system and front-mounted centering guides assist with center alignment within the truck bed.
- 4 Happijac Qwik-Load™ front and rear turnbuckles safely and securely attach and anchor the camper to your truck.
- 5 Air Lift® Super Duty™ air springs ("air bags") increase stability and levels the rig by transferring rear axle load forward.
- 6 Rancho® RS-9000X™ front and rear shocks greatly improve ride in all weather and road conditions.
- 7 Air Lift Wireless Air™ in-cab remote control controls the air compressor and pressure for the air springs ("air bags") and shocks.
- 8 Lance Custom Design™ cabover shocks ("cabover struts") reduce the impact of up-and-down motion from irregular roads.
- 9 Rear-mounted centering guides assist in positioning your camper within the truck bed, and are available for most truck models.

dealer-installed support equipment



4

Happijac Qwik-Load turnbuckle upgrades make anchoring your camper a snap.



8

Lance-exclusive cabover shocks ("cabover struts") have quick-release stainless steel connectors.



2

Wireless rear-view camera/monitor maximizes safety.



REESE
CERTIFIED

Lance recommends Reese towing products.



When not towing loads that require an extended hitch, included in Reese's Tow Beast system is a **reducer sleeve**, which you use to reconnect the hitch ball and draw bar to the receiver hitch.



The 48-inch Reese Tow Beast Class V hitch box extension ("tow bar") is constructed with a heavy steel tube inside another steel tube - welded together - to dramatically increase strength and towing capacity.



5

Within Air Lift's Super Duty air springs ("air bags") are the Lance-exclusive internal jounce bumpers - which gradually cushion the suspension of the air springs as they approach the end of their jounce travel.

Installation of these support equipment systems by your Factory Authorized Lance Dealer is highly recommended to ensure you receive "The Ultimate Ride." Experience a dramatic improvement in the drivability and handling of your truck and camper rig - in any weather, on any road.

- 1 Reese® Tow Beast™ Class V hitch/extension system increases your towing capabilities over your truck's factory-stock hitch.
- 2 Wireless rear-view camera/microphone and seven-inch in-cab LCD monitor lets you see - and hear - what's behind you.
- 3 Happijac® frame-mount anchoring system and front-mounted centering guides assist with center alignment within the truck bed.
- 4 Happijac Qwik-Load™ front and rear turnbuckles safely and securely attach and anchor the camper to your truck.
- 5 Air Lift® Super Duty™ air springs ("air bags") increase stability and levels the rig by transferring rear axle load forward.
- 6 Rancho® RS-9000X™ front and rear shocks greatly improve ride in all weather and road conditions.
- 7 Air Lift Wireless Air™ in-cab remote control controls the air compressor and pressure for the air springs ("air bags") and shocks.
- 8 Lance Custom Design™ cabover shocks ("cabover struts") reduce the impact of up-and-down motion from irregular roads.
- 9 Rear-mounted centering guides assist in positioning your camper within the truck bed, and are available for most truck models.

towing

One of the many advantages of choosing a Lance truck camper as your RV is the ability to **tow all your toys**.



Center position

The rear step can be moved to allow room for a hitch



Towing position

Undercarriage of a Lance camper with a Reese Tow Beast hitch/extension system highlighted



When towing items behind larger Lance camper models, extending the hitch from the truck rearward to the camper bumper is necessary. (See chart at the right for towing capacities of all models.) The method Lance recommends involves a truck-mounted Class V receiver hitch and hitch box extension (as detailed in the 3-D view photos on the dealer-installed equipment section on page 15 inside). A draw bar with hitch ball is inserted into the hitch box extension, the same way it would be inserted into the receiver hitch itself.

Reese manufactures the Tow Beast Class V receiver hitch and hitch box extension specifically for truck camper applications. It replaces standard truck factory-stock receivers to allow for a greater towing capacity over factory-stock hitch systems. The other important benefit is that the Reese Tow Beast Class V system doesn't require you to attach the receiver hitch or hitch box extension to the camper. The hitch box extension can be in place when loading or unloading your camper – and the rear step can be moved to allow room for the hitch (see pictures at left). For very heavy loads, the hitch box extension in combination with a weight-equalizing hitch can be used. The chart at the right gives capacities for Reese hitches.

Always observe your truck's tow ratings – and the advice of your Factory Authorized Lance Dealer. Their service teams have the knowledge, experience and skill to outfit your rig correctly.



WEIGHT CARRYING/
TONGUE WEIGHT

WEIGHT DISTRIBUTING/
TONGUE WEIGHT

TOW CAPACITIES (IN POUNDS) FOR THE LANCE MODEL REQUIRING ONLY A REESE TOW BEAST CLASS V RECEIVER HITCH

Lance Model	Weight Carrying/Tongue Weight	Weight Distributing/Tongue Weight
Lance 850	12,000/1200	14,000/1400

TOW CAPACITIES (IN POUNDS) FOR LANCE MODELS REQUIRING BOTH A REESE TOW BEAST CLASS V RECEIVER HITCH AND HITCH BOX EXTENSION

Dealer modifications required. Consult your Factory Authorized Lance Dealer for professional technical advice and proper equipment installation. A universal heavy-duty 34" or 48" factory-stock Reese extension is cut down by a technical service professional to fit your particular application.

Lance Model	Weight Carrying/Tongue Weight	Weight Distributing/Tongue Weight	Length of Cut Extension
Lance 825 Lance 830 Lance 855 Lance 855S Lance 865 Lance 950 Lance 950S Lance 992	6000/600	8000/800	34" extension cut to 24"
Lance 1050 Lance 1050S Lance 1181 Lance 1191	5000/500	7500/750	48" extension cut to 41"

All above weights, dimensions and capacities are approximate values – and subject to change without notice. All measurements are based on an 8.75-inch standard drop ball mount. Some capacities may vary depending on vehicle application. **Be safe – always consult with your Factory Authorized Lance Dealer beforehand.**



towing

One of the many advantages of choosing a Lance truck camper as your RV is the ability to **tow all your toys**.



Center position

The rear step can be moved to allow room for a hitch

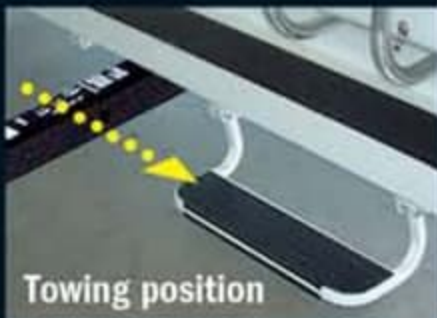

Towing position



When towing items behind larger Lance camper models, extending the hitch from the truck rearward to the camper bumper is necessary. (See chart at the right for towing capacities of all models.) The method Lance recommends involves a truck-mounted Class V receiver hitch and hitch box extension (as detailed in the 3-D view photos on the dealer-installed equipment section on page 15 inside). A draw bar with hitch ball is inserted into the hitch box extension, the same way it would be inserted into the receiver hitch itself.

Reese manufactures the Tow Beast Class V receiver hitch and hitch box extension specifically for truck camper applications. It replaces standard truck factory-stock receivers to allow for a greater towing capacity over factory-stock hitch systems. The other important benefit is that the Reese Tow Beast Class V system doesn't require you to attach the receiver hitch or hitch box extension to the camper. The hitch box extension can be in place when loading or unloading your camper - and the rear step can be moved to allow room for the hitch (see pictures at left). For very heavy loads, the hitch box extension in combination with a weight-equalizing hitch can be used. The chart at the right gives capacities for Reese hitches.

Always observe your truck's tow ratings - and the advice of your Factory Authorized Lance Dealer. Their service teams have the knowledge, experience and skill to outfit your rig correctly.



Trailer wiring harness plug

Trailer wiring harness

Safety chains

Hitch box extension ("tow bar")

Class V receiver hitch attached to underside of truck



WEIGHT CARRYING/
TONGUE WEIGHT

WEIGHT DISTRIBUTING/
TONGUE WEIGHT

TOW CAPACITIES (IN POUNDS) FOR THE LANCE MODEL REQUIRING ONLY A REESE TOW BEAST CLASS V RECEIVER HITCH

Lance 850	12,000/1200	14,000/1400
-----------	-------------	-------------

TOW CAPACITIES (IN POUNDS) FOR LANCE MODELS REQUIRING BOTH A REESE TOW BEAST CLASS V RECEIVER HITCH AND HITCH BOX EXTENSION

Dealer modifications required. Consult your Factory Authorized Lance Dealer for professional technical advice and proper equipment installation. A universal heavy-duty 34" or 48" factory-stock Reese extension is cut down by a technical service professional to fit your particular application.

LENGTH
OF CUT EXTENSION

Lance 825			
Lance 830			
Lance 855			
Lance 855S	6000/600	8000/800	34" extension cut to 24"
Lance 865			
Lance 950			
Lance 950S			
Lance 992			
Lance 1050			
Lance 1050S	5000/500	7500/750	48" extension cut to 41"
Lance 1181			
Lance 1191			

All above weights, dimensions and capacities are approximate values - and subject to change without notice. All measurements are based on an 8.75-inch standard drop ball mount. Some capacities may vary depending on vehicle application. **Be safe - always consult with your Factory Authorized Lance Dealer beforehand.**

Undercarriage of a Lance camper with a Reese Tow Beast hitch/extension system highlighted

