

**LANCE**





In a world full of choices and ever-changing trends, some things manage to stand the test of time. Lance Mfg. Co.'s 60-year history as a premier recreational vehicle builder and reputation for attention to quality are two of those things. Over the past six decades, Lance has developed a recipe at the heart of every product that has advanced through time.

The Lance Manufacturing Company, as you know today, began in 1965 in a 500-square-foot facility with the simple goal of building the best slide-in bed truck campers' money can buy. Through innovation, design, advancements in materials, and hard work, Lance Mfg. Co. RV brands have become a premier choice for RV owners across North America.

Precision is key, with every screw location predetermined by computer modeling software, and true 90-degree angles achieved through computer design and CNC cutting. From laser-guided CNC machines and a temperature- and humidity-controlled facility to the little details, such as in-house sewn upholstery or open floor plans with maximized storage and windows, Lance-branded RVs are a combination of modernization and a can-do attitude aimed at creating the most durable camping machines on the road.

Because your RV choice is important, we are excited and honored to show you why you should choose "The Lance"!





Lapis Interior



**SPECIFICATIONS**

Floor Length	11'-11"
Overall Length	20'-4"
Overall Length W/Optional UltraDeck Plus Bumper	N/A
Width (Exterior)	96"
Height (Exterior) A/C	9'-0"
<i>Note: W/Optional Truma Aventa 13.5M</i>	
Height (Interior)	80"
Dry Weight	4318
Wet Weight	4772
CG Front	61"
CG Rear	35"
Sleeping Capacity (Min./Opt. Max.)	(5/6)
Fresh Tank (Gal)	42
Gray Tank (Gal)	35
Black Tank (Gal)	35

**Designed for 1 Ton 350/3500+ Long Bed  
Duel Rear Wheel Trucks**



Grayson Interior



TOW A HORSE TRAILER



TOW A BOAT



TOW YOUR TOYS



FERRY CROSSING



OVERLANDING



REMOVE THE CAMPER

## DO IT ALL IN A LANCE TRUCK CAMPER

A truck camper is the most versatile RV experience available to you. You do not have the same limitations as other RVs. When you own a truck camper, you enjoy all the benefits of other RVs. When placed on your truck, you have all the maneuverability to travel and park, plus all of your truck's 4x4 and towing capabilities. Do you have any hobbies? Truck campers are an excellent support vehicle for towing them to their destination. Do you travel off-road? Put it in a 4x4. Are you worried about driving an RV? You're driving a truck! You can even remove the camper using its remote-control jacks. Our campers can be left at the campsite for sightseeing, running errands, putting the boat in the lake, taking the quads further up the trail, or engaging in more technical off-road exploration.





**SPECIFICATIONS**

Floor Length	10'-11"
Overall Length	20'-0"
Overall Length W/Optional UltraDeck Plus Bumper	20'-5"
Width (Exterior)	96"
Height (Exterior)	9'-0"
<i>Note: W/Optional Truma Aventa 13.5M A/C</i>	
Height (Interior)	79"
Dry Weight	3671
Wet Weight	4131
CG Front	48"
CG Rear	48"
Sleeping Capacity (Min./Opt. Max.)	(4/4)
Fresh Tank (Gal)	45
Gray Tank (Gal)	27
Black Tank (Gal)	22

**Designed for 1 Ton 350/3500+ Long Bed Trucks**



# MATCHING YOUR TRUCK & CAMPER

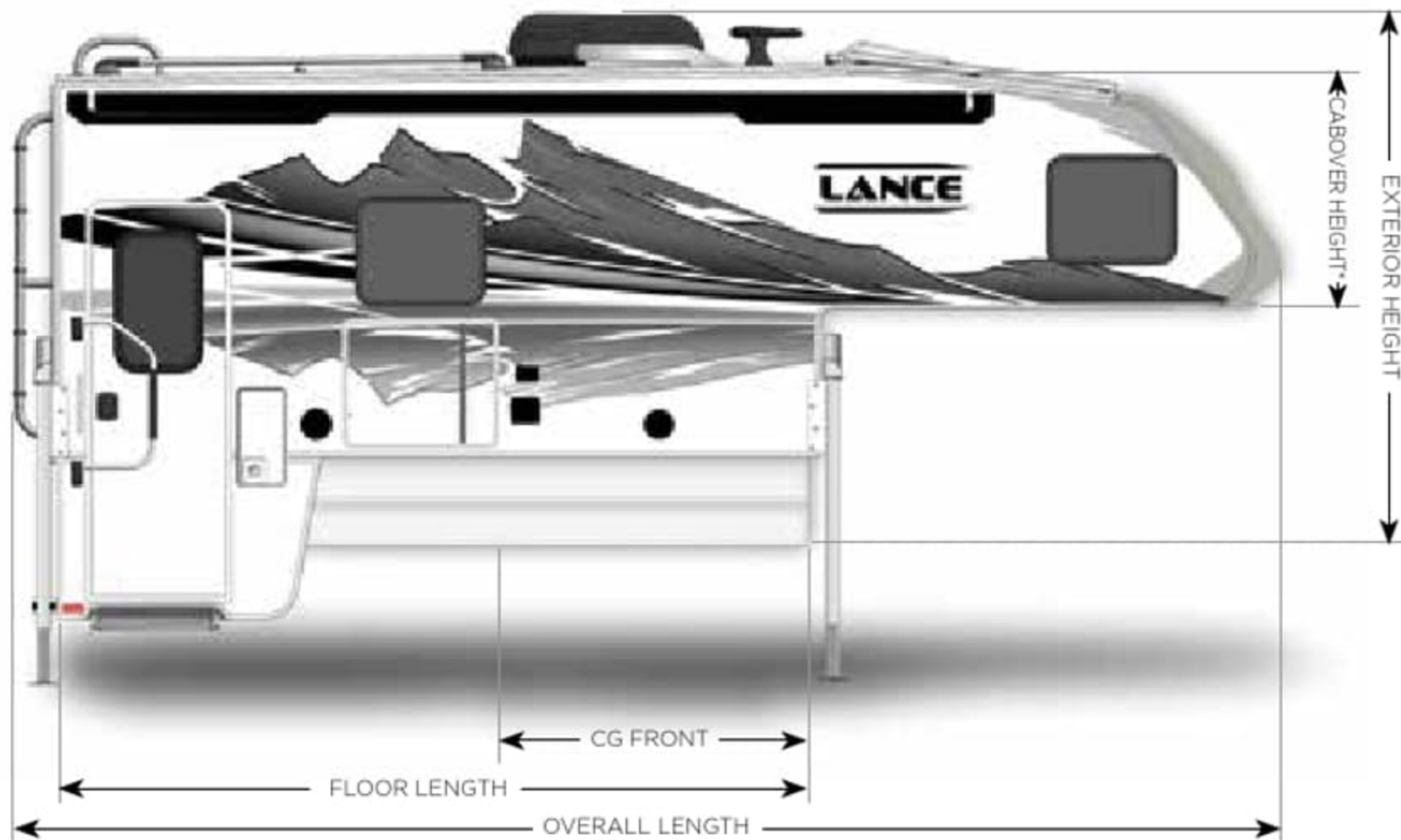

\* Measured from Inside



Finding the perfect camper for your truck OR the ideal truck for your dream camper is as easy as 123.

## TRUCK/CAMPER COMPATIBILITY GUIDE

These are general guidelines to use when matching a Lance camper to your truck and assumes standard equipment on both the truck and camper. Lance makes no warranties or representation - express or implied - as to performance or reliability of your truck with a Lance camper. For professional guidance, always consult with your Factory Authorized Lance Dealer.

### HEAVY DUTY F-250/2500 SERIES 6'+ Short Beds

Lance 650  
Lance 825  
Lance 850  
Lance 865



### HEAVY DUTY F-250/2500 SERIES Single Rear Wheel 8' Long Beds

Lance 850



### HEAVY DUTY F-350/3500 SERIES Single Rear Wheel 6'+ Short Beds

Lance 650  
Lance 825  
Lance 850  
Lance 855s  
Lance 865



### HEAVY DUTY F-350/3500 SERIES Single Rear Wheel 8' Long Beds

Lance 850  
Lance 960  
Lance 975  
Lance 1062



### HEAVY DUTY F-350/3500 SERIES Dual Rear Wheel 8' Long Beds

Lance 850  
Lance 960  
Lance 975  
Lance 1062  
Lance 1172



**BED SIZE:** Heavy-duty full-size trucks typically come in two sizes. "Long bed" 8' or "Short bed" 6'4" - 6'10" depending on manufacturer. We build camper options for both lengths.

Long Bed: 850, 960, 975, 1062, 1172 (1172 Dual rear wheels recommended)

Short Bed: 650, 825, 865, 850, and 855s

**PAYLOAD CAPACITY:** The amount of weight a truck manufacturer recommends you place in the bed. To calculate this number, subtract the curb weight of the vehicle from the recommended GVWR. The GVWR information for your truck is located on a sticker on the driver's side door; often the curb weight is located there as well, or you can visit your local scale.

$$\text{GVWR} - \text{Curb Weight} = \text{Payload Capacity}$$

**CAMPER WEIGHT:** Our lineup of truck campers differs in size and layout, resulting in a variety of options. To match, look at the Wet Weight with standard equipment of the camper and add an estimation of the added weight of optional equipment and your personal items.

$$\text{Payload Capacity} - \text{Camper weight} = \text{Match}$$

(result should be a positive number)



### SPECIFICATIONS

Floor Length	10'-4"
Overall Length	19'-5"
Overall Length W/Optional UltraDeck Plus Bumper	19'-10"
Width (Exterior)	96"
Height (Exterior)	9'-0"
<i>Note: W/Optional Truma Aventa 13.5M A/C</i>	
Height (Interior)	79"
Dry Weight	3675
Wet Weight	4138
CG Front	49"
CG Rear	47"
Sleeping Capacity (Min./Opt. Max.)	(4/4)
Fresh Tank (Gal)	45
Gray Tank (Gal)	30
Black Tank (Gal)	26

**Designed for 1 Ton 350/3500+ Long Bed Trucks**



# THE LANCE DIFFERENCE

## DESIGN & CONSTRUCTION

- A. The fiberglass exterior walls are laminated under intense pressure with heat-setting adhesives for years of trouble-free use.
  - B. The roof is covered in energy-star rated synthetic membrane material. Integrated rain gutters and drip spouts prevent the sides of your trailer from streaking.
  - C. Interiors are constructed of Euro-Ply which Lance imports. This superior product is lighter, formaldehyde free and stronger providing both beauty and durability.
  - D. With an aluminum-framed superstructure, the entire camper fits together like a perfect puzzle. "LanceLock™" features interlocking aluminum extrusions to connect all exterior panels.
  - E. Lance utilizes an arrangement of composite materials in a laminated and pressure bonded sandwich construction for structural integrity, superior insulation and sound absorption.
  - F. Rigid block foam insulation fits tight to resist sagging and promotes structural strength. Four Season package also features insulated bed pad.
  - G. Beautiful and aerodynamic, the nose cap is made of TPO, the same material used for bumpers on automobiles. Its high gloss finish is resilient and resistant to the abuses of the road. Its slick surface makes it easier to clean.
- 3D advanced CAD engineering create precise plans that run CNC machinery. The result is that every part is the same and perfect every time.

Keeping it all together are stainless steel fasteners. Unlike our competitors, this expensive hardware resists corrosion making for a lasting investment.

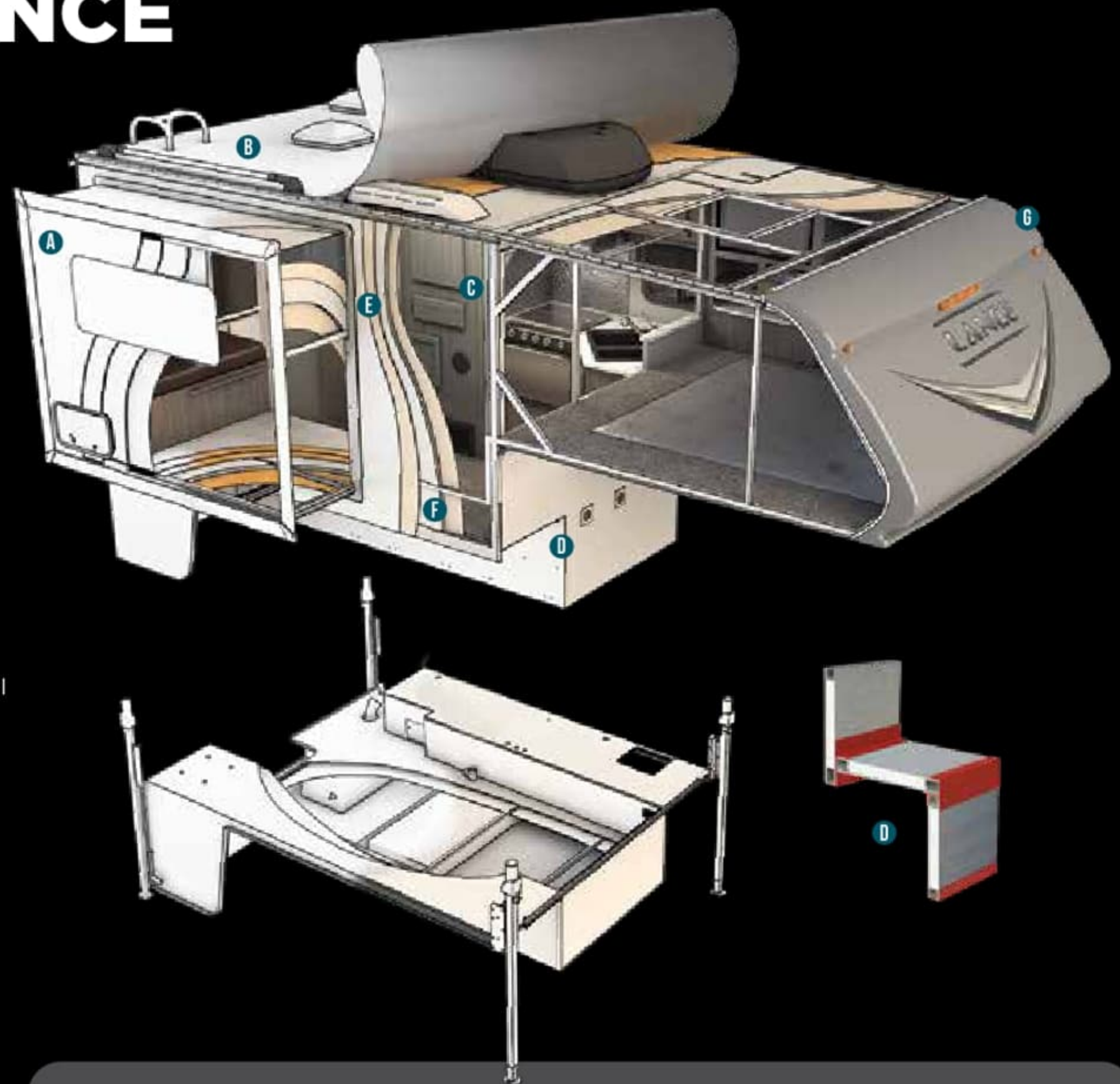

## COMPUTER DESIGNED & CUT

Numerical control machining (CNC), uses computer programs to control tools like routing tables to create a close-tolerance high-quality fit. When the angles in your RV are true 90 degree, your RV is more structurally sound to stand the test of use over time.



## COMPOSITE CONSTRUCTION

Lance uses Azdel Onboard® composite panels, a patented blend of polypropylene and fiberglass to create a strong, lightweight, quiet, weather and temperature resistant, odorless and environmentally friendly wall that will increase the life of your RV.

We call that high MPM, memories per mile!

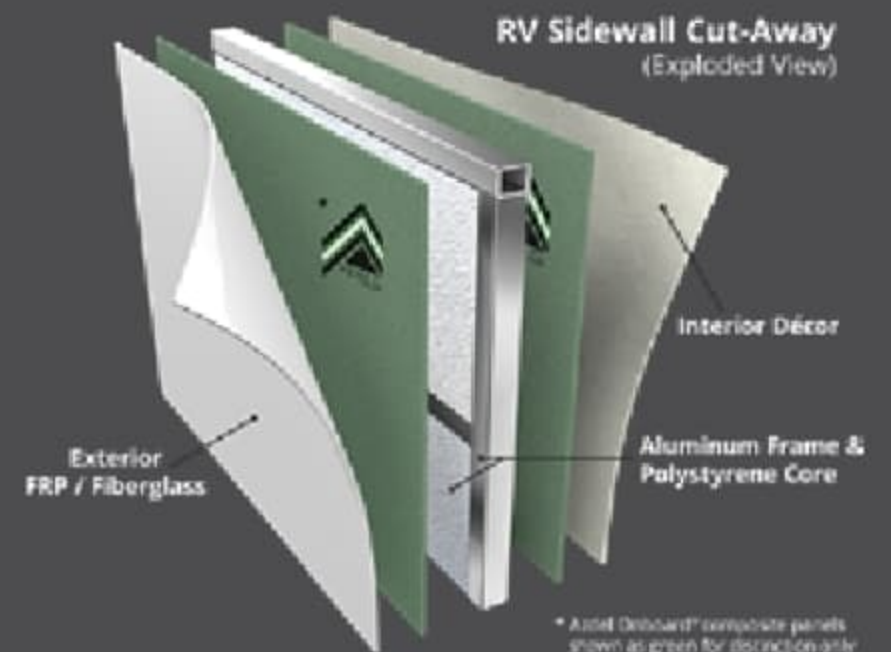

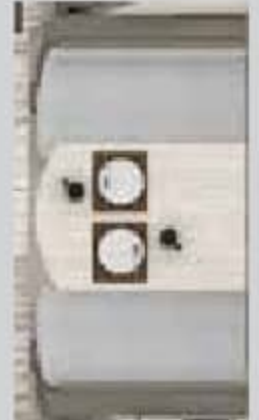

Optional Couple's Dinette



Optional Residential Styled Sofa W/Two Tables

## SPECIFICATIONS

Floor Length	9'-11"
Overall Length	19'-0"
Overall Length W/Optional UltraDeck Plus Bumper	19'-5"
Width (Exterior)	96"
Height (Exterior)	9'-0"
<i>Note: W/Optional Truma Aventa 13.5M A/C</i>	
Height (Interior)	79"
Dry Weight	3254
Wet Weight	3717
CG Front	47"
CG Rear	49"
Sleeping Capacity (Min./Opt. Max.)	3
Fresh Tank (Gal)	45
Gray Tank (Gal)	30
Black Tank (Gal)	28

**Designed for 1 Ton 350/3500+ Long Bed Trucks**





We have been the proud owners of two Lance Campers. A 1993 Model 980 that we owned for 23 years, then upgraded to our current 2017 Model 1062. Many trips were taken in these campers—too many photos to share AND choose from. We love the ease of traveling to destinations in our camper. And it can get to places that a bigger rig could not. Fun Fun!!

Linda & Greg T | 2017 1062 | Durango, CO



I use my camper for hunting, fishing, and just random camping adventures. I've owned travel trailers and toy haulers, and my camping trips always seem to be a lot of work. My Lance camper has really simplified my trips, and now it feels like I'm on vacation rather than working the whole time. The camper is so versatile that I can remove the camper to use it for camping and use the truck to put the boat in the water. On my hunts, I pull the Jeep behind the truck and leave the camper on the truck, so all I have to do is unhook the Jeep, level the truck, put my chairs and grill out, and camp is set.

William R | 2021 650



We've had our Lance for about five years now and couldn't be more happy. Every time we were at the beach, we would see people with campers and say, "One Day." Well, when that day came, it changed our lives. We made new friends, which created freedom for us to go to the beach whenever we wanted and even travel to other places. We purchased a Lance truck camper to be able to drive on the beaches in New York. We're able to spend quality time with our friends and family and, at the same time, have all the comforts of home. I wouldn't have changed a thing.

Stacey | 2018 850 | New York, NY



### SPECIFICATIONS

Floor Length	8'-11"
Overall Length	17'-7"
Overall Length W/Optional UltraDeck Plus Bumper	N/A
Width (Exterior)	96"
Height (Exterior)	9'-0"
<i>Note: W/Optional Truma Aventa 13.5M A/C</i>	
Height (Interior)	76"
Dry Weight	2706
Wet Weight	3040
CG Front	34"
CG Rear	62"
Sleeping Capacity (Min./Opt. Max.)	(5/5)
Fresh Tank (Gal)	30
Gray Tank (Gal)	20
Black Tank (Gal)	18

**Designed for ¾ Ton 250/2500+ Short OR Long Bed Trucks**



# STANDARD FEATURES



SkyMaxx Skylight Vent In Cab-Over. This large vent/skylight provides options of full sun, full shade, or a partial sun/shade combination.



Keyless Entry. This keypad entry allows you the freedom to head out and explore without keys jingling in your pack or swimsuit.



Exterior Wash Station. Rinse your gear or yourself after a day's camping expedition.



Exterior Propane Connection. Link into and draw from your onboard tanks for a BBQ or other accessory.



Solid Surface Galley Area Countertop. Beautiful to live with and non-porous, durable, and easy to maintain.



12V Refrigerator. More space and efficiency with this electric operation variable speed compressor model.



Carpeted & Insulated Bed Base. The cabover has both carpeting and insulation material beneath the bed.



Residential Size Queen Mattress. No RV queens here! A real full length queen mattress that fits your sheets from home.



12V/USB Charging Port in Dinette and Cab-Over Areas. Charge your accessories for another day of making and capturing memories.

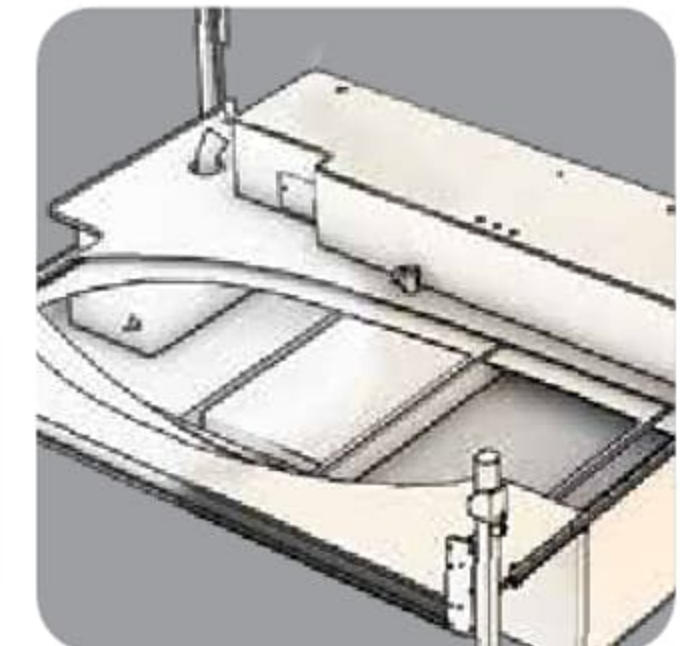

Black Tank Flush. Connect an exterior house to rinse, flush and clean your tank after use.



Quality brands are partnering for a better RV experience. Ultra quiet. Super-efficient. A better experience for you during ownership.



Truma Aventa Air Conditioner



Truma Combi



Truma Varioheat



Truma Aquago



**SPECIFICATIONS**

Floor Length	8'-11"
Overall Length	18'-0"
Overall Length W/Optional UltraDeck Plus Bumper	N/A
Width (Exterior)	96"
Height (Exterior)	8'-9"
<i>Note: W/Optional Truma Aventa 13.5M A/C</i>	
Height (Interior)	81"
Dry Weight	3064
Wet Weight	3398
CG Front	39"
CG Rear	39"
Sleeping Capacity (Min./Opt. Max.)	(4/5)
Fresh Tank (Gal)	30
Gray Tank (Gal)	20
Black Tank (Gal)	25

**Designed for 1 Ton 350/3500+ Short Bed Trucks**



# OPTIONAL FEATURES



Lance Load Roof Rack System. Bring your kayak, canoe, or extra storage pod along for the adventure.



Antenna LTE/cell booster. It improves your cell phone's voice and data range, potentially allowing it to function as a Wi-Fi hotspot.



Rear Awning. The awning can be either pull-out or electric, depending on the specific model. Shade your door and rear your camper.



Latitude Awning with a Wind Sensor. Lateral arms eliminate head-knocking horizontal supports and allow for more windows to be added.



Convection/Micro-Air Fryer. It combines the rapid cooking capabilities of microwave ovens with the browning and crisping of a traditional oven.



Ultra Deck Plus. This beefy rear bumper provides more storage and a landing deck.



Ladder & Maggie Rack. Gain entry to your roof with this heavy duty ladder and a place to mount cross bars.



Lithium Batteries. A lighter and more efficient battery that lasts longer and does not require ventilation.



Solar Panel(s). Depending on the model, you can use up to two 100W solar panels. Harness the sun to charge your onboard batteries.



Generator: 2500 Watt LPG (Onan). This propane generator provides true off-grid independence and functionality for all systems. Available on select models



Satellite Dish Self-Locating. Connect to your satellite TV service.



Backup Camera with Wireless Monitor. This significantly enhances the enjoyment of the back-in and set-up processes.



Full-bladed fan. Ensure your RV stays well-ventilated and dry in any weather condition.



Awning Slide-Out Cover(s). Keep debris off the roof; any debris that falls onto the topper tends to slide off easily.



Child Bunks. Select models offer additional sleeping areas for young children in overhead spaces.



### SPECIFICATIONS

Floor Length	8'-7"
Overall Length	16'-5"
Overall Length W/Optional UltraDeck Plus Bumper	N/A
Width (Exterior)	86"
Height (Exterior)	8'-0"
<i>Note: W/Optional Truma Aventa 13.5M A/C</i>	
Height (Interior)	77"
Dry Weight	2297
Wet Weight	2515
CG Front	35"
CG Rear	43"
Sleeping Capacity (Min./Opt. Max.)	(5/5)
Fresh Tank (Gal)	30
Gray Tank (Gal)	14
Black Tank (Gal)	13

**Designed for ¾ Ton 250/2500+ Short Bed Trucks**

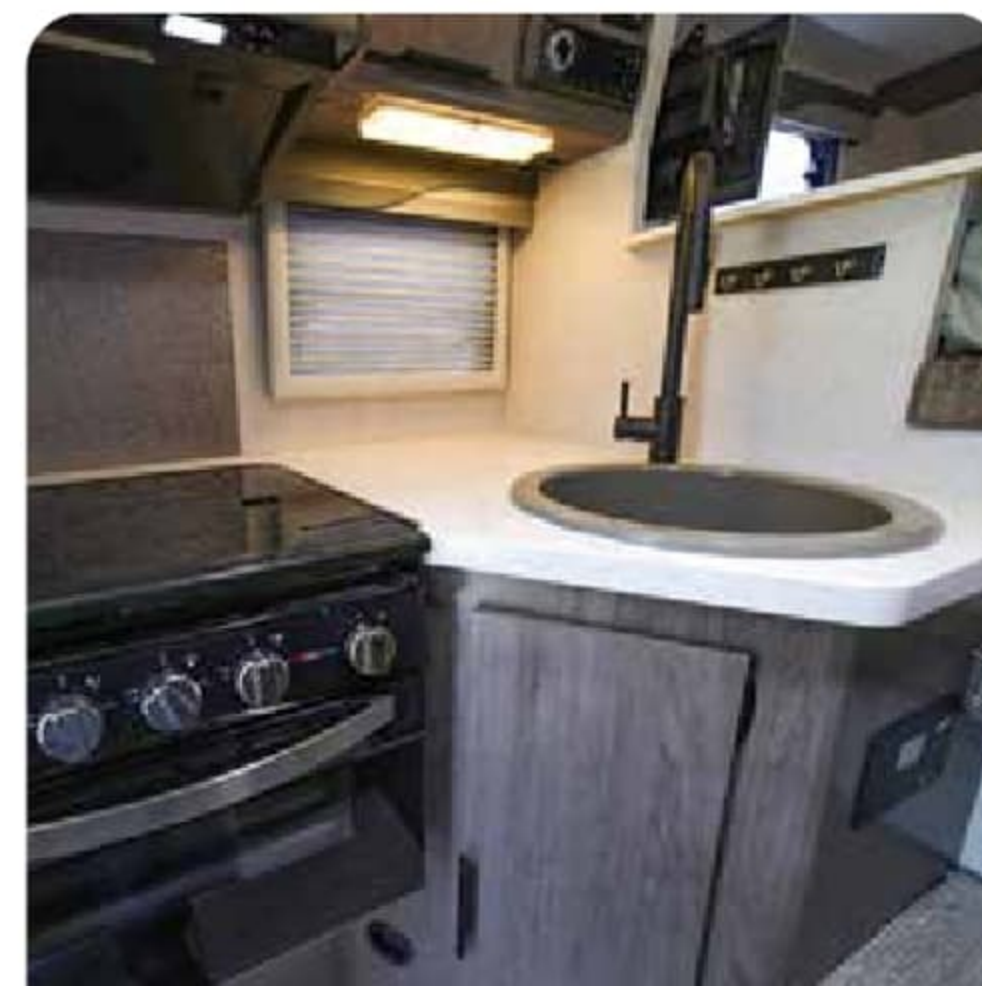

# THE TRUCK CAMPER EXPERIENCE

No matter what you're into, a Lance truck camper is the purpose-built support vehicle you need. They drive like your truck and tow like your truck. Your passions are an extension of you. Bring your passion to wherever you want to be and don't compromise on your adventure.



FAMILY



CARRYING CARGO

"I saw in their eyes something I was to see over and over in every part of the nation—a burning desire to go, to move, to get under way, anyplace, away from any Here. They spoke quietly of how they wanted to go someday, to move about, free and unanchored, not toward something but away from something. I saw this look and heard this yearning everywhere in every states I visited. Nearly every American hungers to move."

— John Steinbeck - *Travels with Charley: In Search of America*



MOUNTAIN BIKING



JEEP 4X4



MOTORCYCLES



CARS & RACING

# ALL THE PLACES YOU CAN GO AND PLACES YOU CAN SEE.

Truck campers are designed to maximize the enjoyment of outdoor living while minimizing costs. Have you ever wanted to visit faraway places but disliked the expenses and hassles of flying and staying in hotels? Or perhaps you're interested in visiting nearby locations, but would prefer a more comfortable time or a short overnight stay? How about remote work and retired life? If you have a truck, you're halfway there. With a Lance Camper on your truck, a day at the beach turns into a home with a view and long road trip is so much more fun when you can pull off wherever you like!





# LANCE'S STORY

Since 1965 Lance has been building America's most popular truck campers. Many of them still on the road - a true testament to the company's philosophy that Quality Comes First. In 2008 Lance released their first ultra-light towable. Pioneering a whole new segment of travel trailer with their computer design and cut, composite construction approach to building RVs.

Ideas born from this approach include the use of SolidWorks™ 3D design software. Implementation of laser guided cutting machines. Manufacturing methods such as the use of LanceLock™, Azdel™, Euro-Ply™ and the removal of Mercury and Formaldehyde. Just to name a few examples of the advanced practices and materials that contributes to Lances high quality, eco-friendly, toxin-free, and longer lasting RVs.

That's why Lance has won the prestigious DSI Award (Dealer Satisfaction Index) award a record number of times and is best in Owner Satisfaction by customers who are often repeat buyers and a source of referrals for new customers.

With home base in California - the nation's most demanding state for building safe products - Lance manufactures from a State-of-the-Art Production Campus: Including a 141,000 square foot, 22-acre main operations address. 65,000 square foot "Automated CNC Manufacturing" building and 40,000 square foot "Innovation Center" where Sales, Marketing and Product Development work in conjunction with the Warranty and Service teams, Lance dealer partners and Lance owner feedback to drive forward improvement and new product design.

Lance offers a comprehensive authorized dealership network across the United States and Canada providing sales and service. All dealer partners go through extensive vetting and training. Whether you're a first-time camper or a repeat customer you are sure to have a top-notch experience if you chose Lance.

April 1975

5410 Vineland, North Hollywood, California 91601  
 (213) 763-3888 or (213) 788-5417  
 Also located at Thousand Oaks, U.S.A. in Irvine, California  
 (714) 551-2913

**PRICE LIST**

1700 SC	\$5595.00
1600	2395.00
1550	2395.00
1475	2295.00
1450	2195.00
1425	2195.00
1400 SC	2295.00
13 Model 375	2095.00
13 Model 350	1995.00
13 Model 300	1795.00
7 1/2 Model 100	1595.00
8 Model 150	1895.00

Note! Model 100 Fits All Small Trucks.

The Above Prices Include Installation and Hook Up.

**OPTIONAL EQUIPMENT ALL PRICES INCLUDE COMPLETE INSTALLATION**

6 Cu. Ft. 3-Way Ref. (Difference)	\$335.00
8 Cu. Ft. 3-Way Ref. (Difference)	275.00
3 Cu. Ft. 3-Way Ref. (Difference)	235.00
12 Volt Coleman Cooler	175.00
Fresh Water Flush Toilet	125.00
Electric Magic Toilet	175.00
Reiss Rest (Difference)	90.00
10,000 BTU Heater w/Blower & Wall Thermostat	145.00
6 Gal. Hot Water Heater	145.00
4 Winco Hydraulic Jacks (2,000 Lb)	175.00
4 Manual Jacks	100.00
Cable Jacks	75.00
Double Folding Bumper Step	24.50
Rear Camper Bumper w/Storage Space & Camper Tow Bar Assembly	149.00
Twin-Away 10" Automatic	189.00
Insta-Away 8" Automatic	169.00
Double Sliding Truck Window	79.00
Camper Sliding Window	25.00
Double Sliding Window Roof	30.00
Connecting Foot	35.00
Camper Choppers Tie Downs Chassis	45.00
Camper Choppers Tie Downs Floor	30.00
Custom Double Insulation Best	75.00
Flexiglass Roof Window	20.00
Roof Privacy Cover	15.00
Chrome Cabover Stabilizers	49.00
Plastic Cabover Stabilizers	39.00
Reinforced Roof, Latch & Ladder	95.00
Dual Batteries (85 Amp Battery)	85.00
30 Gal. Holding Tank	100.00
20 Gal. Holding Tank	80.00
Propane Tank	35.00
Interior Light	20.00
Pro Speakers	18.00
Super Guides	18.00
Wheeled Retain Gauge	15.00
Table	10.00
Wood Glass	40.00
4-Out Bath Bed	45.00
Over Extension and Over Load Weights	Prices Available On Request

**Lance CAMPERS** Your One Stop RV Center!

Order your next... All you need for your Camper, Trailer or RV, is Lance Campers' Showroom/Service Center.

- SALES: New & Used Trucks, Campers & RVs, Motor Homes
- FINANCING: We'll finance your next purchase with low rates and flexible terms
- SERVICE: Authorized service center for all applications
- REPAIRS: Major & Minor Structural Repairs
- ACCESSORY STORE: Parts, Supplies & More!

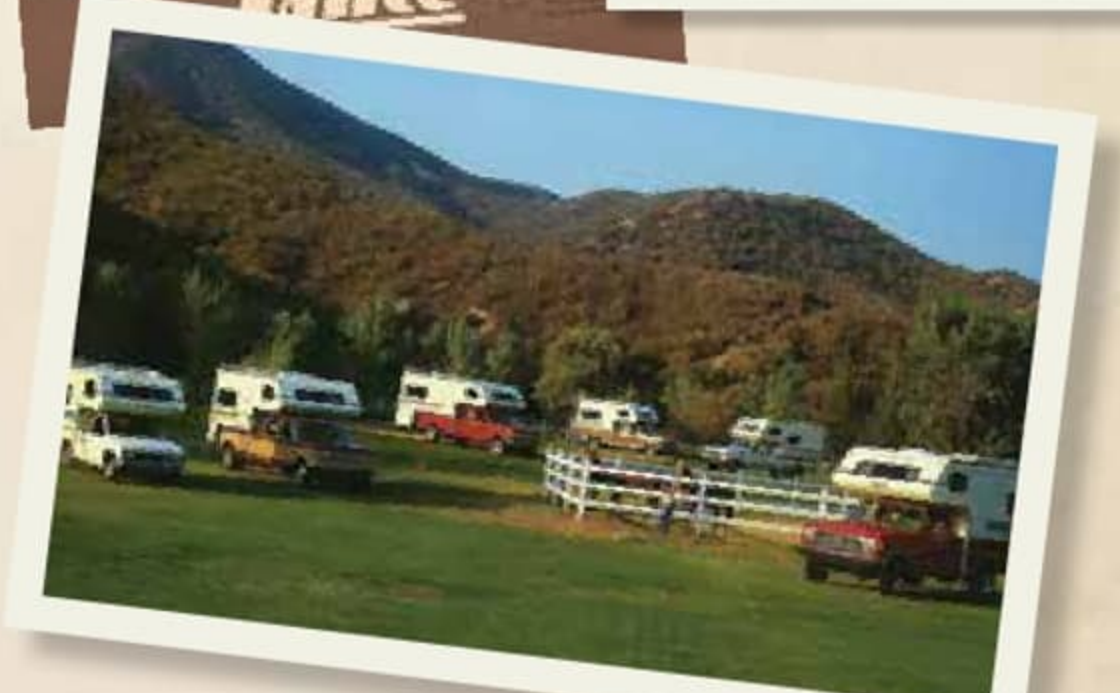



### SPECIFICATIONS

Floor Length	8'-6"
Overall Length	16'-3"
Overall Length W/Optional UltraDeck Plus Bumper	N/A
Width (Exterior)	86"
Height (Exterior)	8'-0"
<i>Note: W/Optional Truma Aventa 13.5M A/C</i>	
Height (Interior)	77"
Dry Weight	2110
Wet Weight	2428
CG Front	33"
CG Rear	45"
Sleeping Capacity (Min./Opt. Max.)	(4/5)
Fresh Tank (Gal)	30
Gray Tank (Gal)	13
Black Tank (Gal)	14

**Designed for ¾ Ton 250/2500+ Short Bed Trucks**



# CAMPING SHOULD BE RELAXING, NOT TAXING.

We have been building truck campers for going on close to 60 years. Many of us here at Lance pride ourselves on real camping experience and a willingness to listen to our owners. So our campers... are made for real campers.



**Automatic Remote Control Jacks** raise and lower your camper at the push of a button to make loading and unloading a breeze.



**Dove-Tailed & Soft Close Drawers, Heavy Duty Overhead Cabinet Hardware** so your gear stays organized and secure.



**TPO one-piece front nose cap** is the first line of defense against wind and water intrusion, borrowed from automotive bumper design is sleek and cannot delaminate unlike wrapped fiberglass noses.



**Dual-Pane Acrylic Windows** look phenomenal, provide superior insulation from the elements, eliminate the hot/cold and moisture transfer of glass/ metal frames and fully open so you can smell the breeze.



### SPECIFICATIONS

Floor Length	6'-10"
Overall Length	15'-6"
Overall Length W/Optional UltraDeck Plus Bumper	N/A
Width (Exterior)	86"
Height (Exterior)	8'-1"
<i>Note: W/Optional Truma Aventa 13.5M A/C</i>	
Height (Interior)	81"
Dry Weight	2061
Wet Weight	2264
CG Front	22"
CG Rear	56"
Sleeping Capacity (Min./Opt. Max.)	(3/3)
Fresh Tank (Gal)	22
Gray Tank (Gal)	15
Black Tank (Gal)	16

**Designed for ¾ ton 2450/2500 Short Bed Trucks**





Grayson



Bronzite



Lapis

## DÉCOR

Variety is the spice of life and what we refer to as the "The Lance Look"! With three stunning selections, all professionally curated to compliment the cabinetry and key interior features, this might be the most challenging decision you'll have to make!

Bronzite - light beige/gray and light gray

Grayson - medium gray and light gray

Lapis - dark blue and light gray

## ENJOY THE RELIABILITY AND CONVENIENCES OF HOME WHEREVER YOUR ADVENTURES MAY TAKE YOU.

Our campers are expertly laid out to be highly usable, spacious and designed to feel like home with modern neutral interiors highlighting a combination of composite and natural extremely durable materials. Familiar quality and functionality insure an instinctive and comfortable transition to a nomadic lifestyle that does not compromise.

We hear they call it "glamping" these days.



Beautiful and durable white quartz solid surface countertops.



Real 3/4" formaldehyde-free wood in all interior walls and cabinetry. Soft close hardware.



Residential faucet fixtures.



# YOUR CAMPER AND YOUR TRUCK.

## TOWING

When towing behind a larger camper, extending the hitch rearward is necessary. Lance recommends the Torklift SuperHitch receiver hitch and hitch box extension. It replaces standard truck factory receivers to allow for greater towing capacities.\*

[www.torklift.com](http://www.torklift.com)

EXTENSION LENGTH	WEIGHT CARRYING/ TONGUE WEIGHT	WEIGHT DISTRIBUTION/ TONGUE WEIGHT
TOW CAPACITIES (IN POUNDS) FOR THE LANCE MODEL <b>REQUIRING ONLY A TORKLIFT SUPERHITCH MAGNUM RECEIVER HITCH</b>		
N/A	15,000/1500	20,000/2000
TOW CAPACITIES (IN POUNDS) FOR LANCE MODELS <b>REQUIRING BOTH A TORKLIFT SUPERHITCH MAGNUM RECEIVER HITCH &amp; HITCH BOX EXTENSION</b> <i>Dealer modifications required. Consult your Factory Authorized Lance Dealer for professional technical advice and proper equipment installation.</i>		
32"	6,500/650	12,000/1200
42" or 48"	6,000/600	12,000/1200
60" extension	5,000/500	10,000/1000

## DEALER INSTALLED SUPPORT EQUIPMENT



### KEY SUPPLIER PARTNERS



1. **Receiver hitch extension** increases your trucks towing capacities and extends your receiver past the camper.
2. **Front & Rear Turnbuckles** are mounted to the frame to safely and securely attach and anchor the camper to your truck.
3. **Air Bags / Air springs** provide better handling and control under heavily loaded conditions.
4. **Sway bars** reduce body roll providing better vehicle control.

Our Lancaster, CA tri facility campus, where all Lance products are manufactured, is unlike any other RV manufacturing facility in the world.



## SIX SIGMA CERTIFIED

Strategies which seek to improve manufacturing quality by identifying and removing the causes of defects and minimizing variability in manufacturing and business processes. This is done by using empirical and statistical quality management methods. Each Six Sigma project follows a defined methodology and has specific value targets, such as reducing pollution or increasing customer satisfaction. The Lean philosophy emphasizes teams working together to find ways to reduce waste.

Our investment in the training and implementation of these practices is sure to continually improve our RVs for our owners for years to come.



# LEAN, GREEN CAMPING MACHINES

## CERTIFIED GREEN: HIGHEST RATING LEVEL: EMERALD

We have been privately evaluated for procedures and practices and measured against criteria based on national consensus standards including: Resource Efficiency, Energy Efficiency, Water Efficiency & Indoor Air Quality. Terms like "Green," "sustainable," and "eco-friendly" are more important now than ever. Transparency is an important factor in your purchasing decision and since our RVs are meant to visit the great outdoors we feel it is important to make sure we are lessening our impact as much as possible. Lance is committed to making smarter construction and component choices which can be seen directly in our use of formaldehyde free wood products, repurposing of dual-layer Azdel wall panels for shower basins and our use of lit-ply wood.



You can smell the difference in a Lance Camper from our recycling to our refusal to use the off-gassing materials you can smell in many of our competitors.

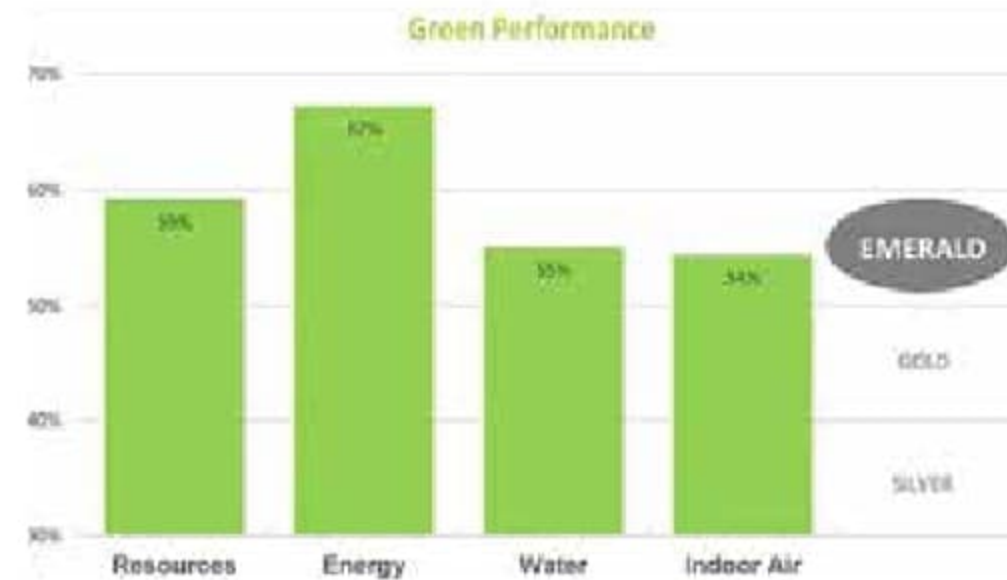



# 4 SEASONS COMFORT TECHNOLOGY

LANCE CAMPERS ARE DESIGNED FOR YEAR ROUND CAMPING. INCLUDING WINTER EXPLORATION.

It's all starts with our precision CNC cut manufacturing process. Our machines ensure true 90 degree angles not only ensuring your camper is structurally sound but also free from drafts. Next we pressure bond all walls, floors and ceilings with high density block foam and create a composite construction sandwich. This endures a high R value and superior insulation, keeping you cool when it's hot and toasty and comfortable when it's cold.

Lastly we house all of your tanks and lines within a fully enclosed basement and pump hot air directly from your furnace- keeping your water systems functional when you need them most. N/A 650



# SPECIFICATIONS, STANDARDS & OPTIONS

	SHORT BED				SB/LB	LONG BED			
	650	825	865	855S		850	960	975	1062
<b>EXTERIOR</b>									
Laminated Fiberglass Bonded Exterior	•	•	•	•	•	•	•	•	•
One-Piece Formed TPO Cab-Over Front Cap	•	•	•	•	•	•	•	•	•
Lance-Lok Basement Truss, Wing and Siderails	•	•	•	•	•	•	•	•	•
Electric Remote Acme Screw Camper Jacks	•	•	•	•	•	•	•	•	•
Swing-Out Jack Brackets	0	0	0	0	0	0	0	0	•
Aluminum Rear Bumper W/Deluxe Bumper Trim				•		•	•	•	
Ultra Deck Plus Bumper							0	0	
Fold-Over Step - Dual Position				•		•	•	•	
Scissor Step (Torklift)	0	0	0		0				
Glow-Step Revolution									•
Radius Acrylic Tinted Thermopane Euro Windows	•	•	•	•	•	•	•	•	•
Ladder and Maggie Rack - Anodized		0	0						
Phat Ladder - Anodized				0	0	0	0	0	0
Roof Rack System		0	0	0	0	0	0	0	0
LED Tail Lights	•	•	•	•	•	•	•	•	•
LED Back-Up Lights	•	•	•	•	•	•	•	•	•
LED Running Lights	•	•	•	•	•	•	•	•	•
LED License Plate Light W/Holder	•	•	•	•	•	•	•	•	•
Radius Cornered Storage Compartment Doors	•	•	•	•	•	•	•	•	•
Keyed-Alike Entry and Storage Compartment Doors	•	•	•	•	•	•	•	•	•
Radius Entry Door W/Window	•	•	•	•	•	•	•	•	•
Keyless Entry	•	•	•	•	•	•	•	•	•
Roof Vent in Cab-Over	•	•	•						
Exit Vent in Cab-Over					•				
SkyMaxx Skylight Vent in Cab-Over				•	•	•	•	•	•
Skylight - Dual Pane Over Galley				•	•	•	•	•	•
Exterior Wash Station	•	•	•	•	•	•	•	•	•
Exterior Propane Connection	•	•	•	•	•	•	•	•	•
Electric Rear Awning Rear (New Carefree Compass)	0	0	0	0	0				
Electric Rear Awning 7'3" W/LED Lighting						0	0	0	
Electric CS Awning 10'-4" W/LED Lighting	0	0	0		0				
Electric CS Awning 12'-0" W/LED Lighting						0	0	0	
Awning Slide-Out Cover				0			0	0/2	0/2
Swing-Out Entry Assist Handle	•	•	•	•	•	•	•	•	•
Exterior Mountain Graphics	•	•	•	•	•	•	•	•	•

## CONSTRUCTION/INSULATION

One-Piece Roof (TPO)	•	•	•	•	•	•	•	•	•
Laminated, Insulated Floor, Cab-Over Bed and Roof	•	•	•	•	•	•	•	•	•
Block Foam Insulation Throughout	•	•	•	•	•	•	•	•	•
Aluminum Framed Walls	•	•	•	•	•	•	•	•	•
Aluminum Framed Floor, Cab-Over Bed and Roof	•	•	•	•	•	•	•	•	•
Azdel Interior Walls	•	•	•	•	•	•	•	•	•
All Weather Package		•	•	•	•	•	•	•	•
-Insulated Battery and LP Compartments									
-Insulated Hatch Covers									
-Water Heater Bypass									

Due to supply-chain issues, certain features shown may have limited or late availability, been substituted or are no longer available. Please see your dealer and the actual unit regarding the features on an individual truck camper.

## INTERIOR/DECOR

	SHORT BED				SB/LB	LONG BED			
	650	825	865	855S		850	960	975	1062
Interior - Grayson	0	0	0	0	0	0	0	0	0
Interior - Bronzite	0	0	0	0	0	0	0	0	0
Interior - Lapis	0	0	0	0	0	0	0	0	0
Solid Surface Galley Area Countertop	•	•	•	•	•	•	•	•	•
Surf-X Suedo Solid Surface Lightweight Countertops and Tables	•	•	•	•	•	•	•	•	•
Lite-Ply Cabinet Construction	•	•	•	•	•	•	•	•	•
Euro Window Treatment W/Combo Screen/Shade	•	•	•	•	•	•	•	•	•
Entry Door Pull Shade	•	•	•	•	•	•	•	•	•
Pull-Out Basement Storage Tray							•	•	•
Hidden Trash Can Compartment							•	•	•
Key Hanger	•	•	•	•	•	•	•	•	•
Wall Clock	•	•	•	•	•	•	•	•	•

## GALLEY/APPLIANCES & EQUIPMENT

Stainless Steel 2-Burner Range	•	•							
Stainless Steel 3-Burner High Output Range W/Oven - 17" Oven			0	0	0	0	0	0	0
Convection/Micro-Air Fryer	0	0	0	0	0	0	0	0	0
12V Double Door Refrigerator (Norcold 7 Cu. Ft.)							•	•	•
3-Way Double Door Refrigerator (Norcold 5 Cu. Ft.)	•	•	•	•	•	•			
2-Way Double Door Refrigerator (Norcold 6 Cu. Ft.)							0	0	0
Heating (Truma Combi 14.3M BTU)	•	•	•				•	•	•
Heating (Truma VarioHeat)				•	•		•	•	•
Propane Tank (#/Gal)	1/5	1/5	1/5	2/5	2/5	2/5	2/5	2/5	2/7
Low Profile Range Hood		•	•	•	•	•	•	•	•
Single Sink (Rectangular)	•	•							
Single Sink (Round)			•						
Double Bowl (Rectangular)				•	•				
Residential "Undermount" Large Single Sink							•	•	•
Pantry W/Adjustable Shelves			•		•		•	•	•
High Spout Galley Faucet	•	•	•						
Residential Single Lever Galley Faucet W/Pull-Out Sprayer				•	•		•	•	•
Sink Cover	•	•	•				•	•	•
Silverware Organizer	•	•	•	•	•		•	•	•
Spice Rack (Varies By Model)	•	•	•	•	•		•	•	•
Pop-Up Electrical / Charging Tower	•	•	•	•	•		•	•	•

## FRESH AND WASTE WATER SYSTEMS

Fresh Tank (Gal)	22	30	30	30	30	45	45	45	42
Gray Tank (Gal)	15	13	14	20	20	30	30	27	35
Black Tank (Gal)	16	14	13	25	18	28	26	22	35
Water Pump W/In-Line Filter	•	•	•	•	•	•	•	•	•
Water Heater (Truma AquaGo)			•	•	•		•	•	•
Water Heater Gas/Electric W/Boost Mode Feature (Truma Combi Eco Plus)	•	•				•			

Option Weights - All weights are estimates and may vary. • = Standard Option 0 = Optional Feature

\*Not intended for children younger than 6 years old.

	SHORT BED				SB/LB	LONG BED			
	650	825	865	855S		850	960	975	1062
<b>BATHROOM</b>									
Marine Toilet - Foot Pedal - Plastic	•	•	•	•	•	•	•	•	•
Black Tank Flush	•	•	•	•	•	•	•	•	•
Medicine Cabinet W/Mirror Door			•	•	•			•	
Storage Cabinet									•
Sliding Bath Door		•	•	•	•				
Hinged Bath Door	•					•	•	•	•
Towel Rod	•	•	•	•	•	•	•	•	•
Skylight - Dual Pane	•	•	•	•	•	•	•	•	•
Ducted Heat	•	•	•	•	•	•	•	•	•
Removable Clothes Rod	•	•	•	•	•		•	•	•

	SHORT BED				SB/LB	LONG BED			
	650	825	865	855S		850	960	975	1062
<b>DINETTE</b>									
Dinette* (Swivel Chairs w/Table 960)	•	•	•	•	•	•	•	•	•
Theater Seating (Sofa)						○	○		○
Facing Dinette Slide-Out				•			•	•	•
Couple Dinette						○			
Locking Pull-Out Storage Drawers				•			•	•	•
Overhead Cabinet Bunk		○	•		•	•			
Bunk Bed W/Child Restraint				○					○
Child Restraint W/Bunk Pad		○	○		○	○			

	SHORT BED				SB/LB	LONG BED			
	650	825	865	855S		850	960	975	1062
<b>CABOVER</b>									
Deluxe Queen Innerspring Mattress W/Pillow Top (60" x 80")				•	•	•	•	•	•
Deluxe Queen (Marine) Mattress W/Pillow Top (60" x 80")	•	•	•						
Bedsread	•	•	•	•	•	•	•	•	•
Headboard				•	•	•	•	•	•
LED Reading Lights	•	•	•	•	•	•	•	•	•
Open Wire Side Overhead Shelves		•	•						
Privacy Curtain	•	•	•	•	•	•	•	•	•
Ducted Heat				•	•	•	•	•	•
Carpeted Bed Base (Insulated)	•	•	•	•	•	•	•	•	•
Front Corner Cabinets, Hamper, Storage Cabinets and O'Heads	•					•			
C/S Wardrobe Cabinet W/Window, Hamper and Ent. Cabinet				•		•	•		
C/S Wardrobe Cabinet W/Window, Hamper and Storage Cabinet							•		
C/S Mirrored Wardrobe Cabinet W/Window									•

	SHORT BED				SB/LB	LONG BED			
	650	825	865	855S		850	960	975	1062
<b>ELECTRICAL</b>									
Systems Monitor Panel	•	•	•	•	•	•	•	•	•
Battery Condition Indicator - LED	•	•	•	•	•	•	•	•	•
Battery Monitor						○			
45 Amp Converter/Loadcenter	•	•	•	•	•	•	•	•	•
Single Battery Compartment	•	•	•						
Dual Battery Compartment				•	•	•	•	•	•
Battery Disconnect	•	•	•	•	•	•	•	•	•
Battery Separator	•	•	•	•	•	•	•	•	•
Battery - Lithium (Double)				○	○	○	○		○
EZ Charge Battery Charging Port	•	•	•	•	•				
LED Interior Lighting	•	•	•	•	•	•	•	•	•
Wall Switched Lighting				•	•	•	•	•	•

	SHORT BED				SB/LB	LONG BED			
	650	825	865	855S		850	960	975	1062
LED Wardrobe Light		•	•	•	•			•	•
12V/USB Charging Port in Dinette and Cab-Over Areas	•	•	•	•	•	•	•	•	•
Cell Phone Charging Pad (Bedroom)	•	•	•	•	•	•	•	•	•
A/C - Truma Aventa 13.5M BTU W/Wall Control and Remote	○	○	○	○	○	○	○	○	○
Pre-Wired for MaxxFan Roof Vent	•	•	•	•	•	•	•	•	•
MaxxFan Roof Vent	○	○	○	○	○	○	○	○	○
Power Roof Vent in Bath	•	•	•	•	•	•	•	•	•
Pre-Wired for Sat Dish/Park Cable	•	•	•	•	•	•	•	•	•
TV Antenna HD	•	•	•	•	•	•	•	•	•
Satellite Dish Self Locating		○	○	○	○	○	○	○	○
Antenna LTE/Cell Booster	○	○	○	○	○	○	○	○	○
AM/FM/DVD Stereo W/Int & Ext Speakers (Bluetooth)	•	•	•	•	•	•	•	•	•
TV 19" (110V)	○	○	○		○				
TV 24" (12V) Smart LCD					○	○	○	○	○
Solar Panel 100 Watt	○	○	○	○	○	○	○	○	○
2nd Solar Panel 100 Watt			○	○	○	○	○	○	○
LED Patio Light - Switched	•	•	•	•	•	•	•	•	•
LED Side Patio Lights	•	•	•	•	•	•	•	•	•
LED Docking Lights	•	•	•	•	•	•	•	•	•
Wireless Remote Slide-Out Control				•			•	•	•
Exterior 110V Patio Outlet	•	•	•	•	•	•	•	•	•
Generator Ready W/Automatic Transfer Switch				•		•	•	•	•
Generator 2500 Watt LPG (Onan)				○		○	○	○	○
Inverter (1500 Watt)						○			
Backup Camera W/Truck Cab Wireless Monitor	○	○	○	○	○	○	○	○	○
CSA	○	○	○	○	○	○	○	○	○
Transport Canada	○	○	○	○	○	○	○	○	○





**2** YEAR  
STRUCTURAL LIMITED  
WARRANTY

**15** YEAR  
ROOF LIMITED  
WARRANTY

Please see [lancecamper.com/warranty](http://lancecamper.com/warranty) for details.

2025 LANCE® TRUCK CAMPER BROCHURE ©2025 Lance Camper Mfg. Corp. (LCMC). All rights reserved. Lance, the Lance logomark, the Lance logomark with chevron, The Lance Look, Lance Custom Design, LanceLock, Discover The Lance Difference, Skyview, Lance Load, Lance Life, LIVE. LANCE. LIFE., REV Group® and other exclusive Lance product names, marks, or designations are trademarks, service marks, or registered trademarks of LCMC. All other marks are property of their respective owners. All product data, graphics and photography, illustrations and/or renderings are kept as accurate as possible. Refinements and changes during the model year and between model years may be made and the actual product received may not match these marketing materials exactly. LCMC reserves the right to change prices, colors, materials, equipment and specifications without notice - as well as to add, modify or discontinue models and features shown in marketing materials and/or on its websites without notice and without incurring obligation. This includes potential changes to parts and design features based on component availability and cost. For any specific model year, parts and features incorporated into the final product, including but not limited Truma air heaters (furnaces) and Truma water heaters, will vary by brand and model. Brochure printed in the USA on FSM paper. 2.5K, Sept 2024 Rev. 1.0.

The information provided in this brochure applies to all 2025 model year products.